

[54] AIR PUMP OR SIMILAR ARTICLE

[75] Inventor: Peter A. Maryanski, Middletown, N.J.

[73] Assignee: Metaframe Corporation, Elmwood Park, N.J.

[**] Term: 14 Years

[21] Appl. No.: 878,932

[22] Filed: Feb. 17, 1978

[51] Int. Cl. D15-02

[52] U.S. Cl. D15/8

[58] Field of Search D15/7-9; 417/413

[56] References Cited

U.S. PATENT DOCUMENTS

D. 197,819	3/1964	Willinger	D15/8
D. 207,363	4/1967	Lovitz	D15/8
D. 217,886	6/1970	Itakura	D15/8
D. 224,356	7/1972	Kondo	D15/8
D. 227,506	6/1973	Kondo	D15/8
D. 247,436	3/1978	Willinger et al.	D15/8

3,539,276	11/1970	Matsoura	417/413
3,671,151	6/1972	Duke et al.	417/413 X
3,825,374	7/1974	Kondo	417/413
3,830,596	8/1974	Kondo	417/413

Primary Examiner—James R. Largen
Attorney, Agent, or Firm—John G. Mesaros

[57] CLAIM

The ornamental design for an air pump or similar article, as shown and described.

DESCRIPTION

The newness, originality, and ornamentality of the present invention will become readily apparent from the features set forth in the accompanying drawings in which:

FIG. 1 is a perspective view of an air pump or similar article showing my new design;

FIG. 2 is the top plan view thereof;

FIG. 3 is an elevational view taken from one side thereof, the opposite side being a mirror image of the side shown;

FIG. 4 is a front elevational view thereof;

FIG. 5 is a bottom plan view thereof; and

FIG. 6 is a rear elevational view thereof.

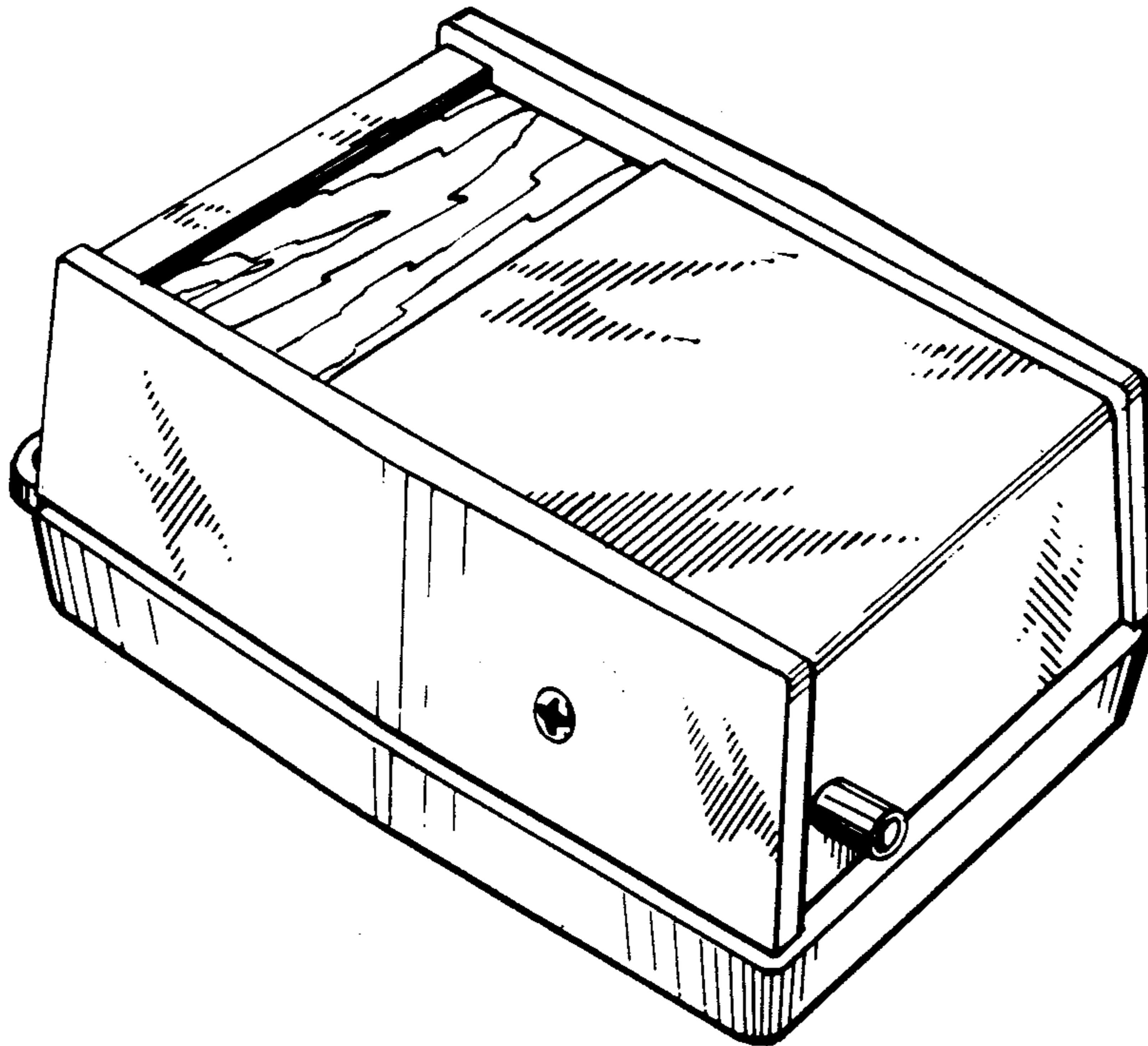

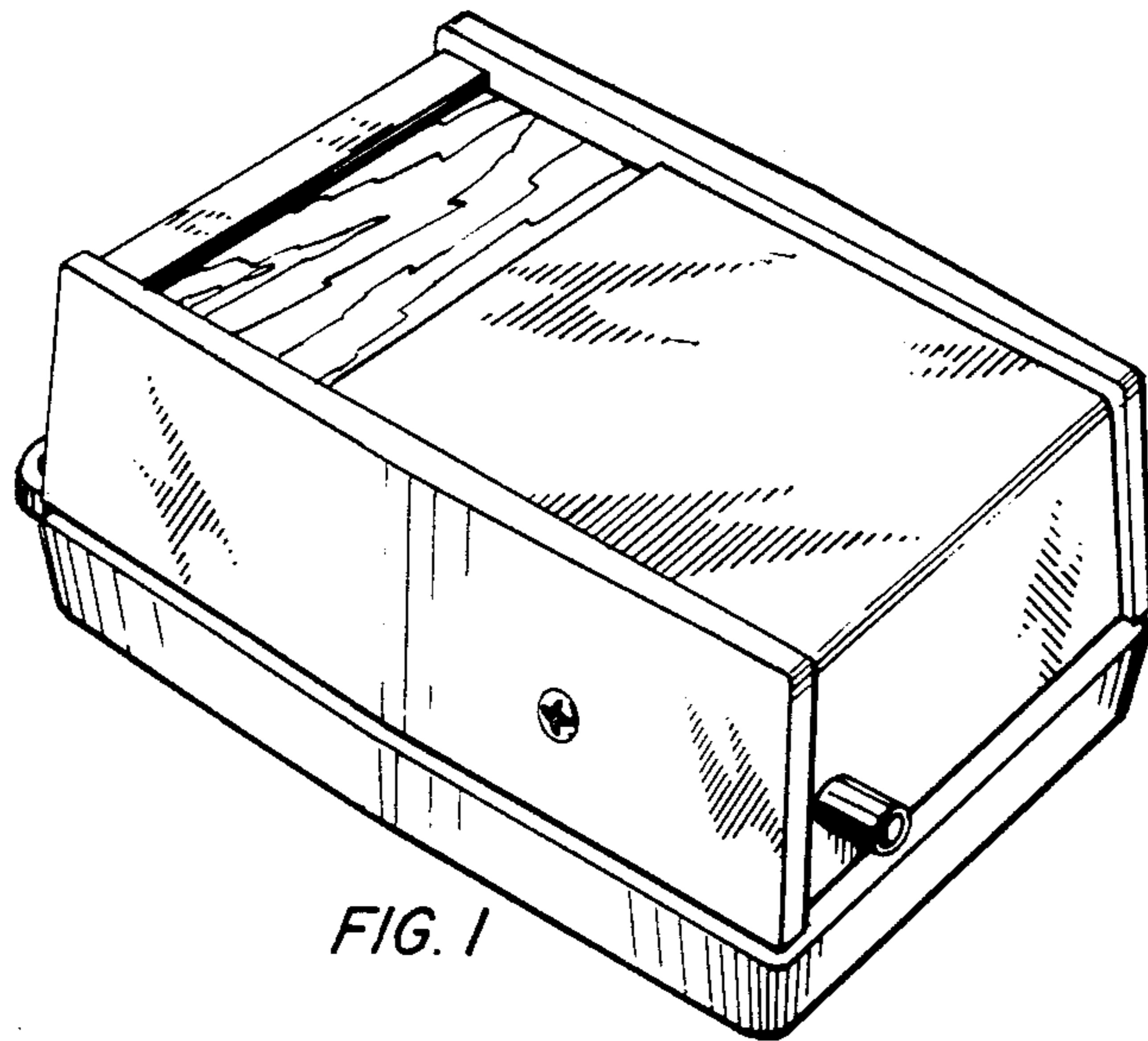

FIG. 1

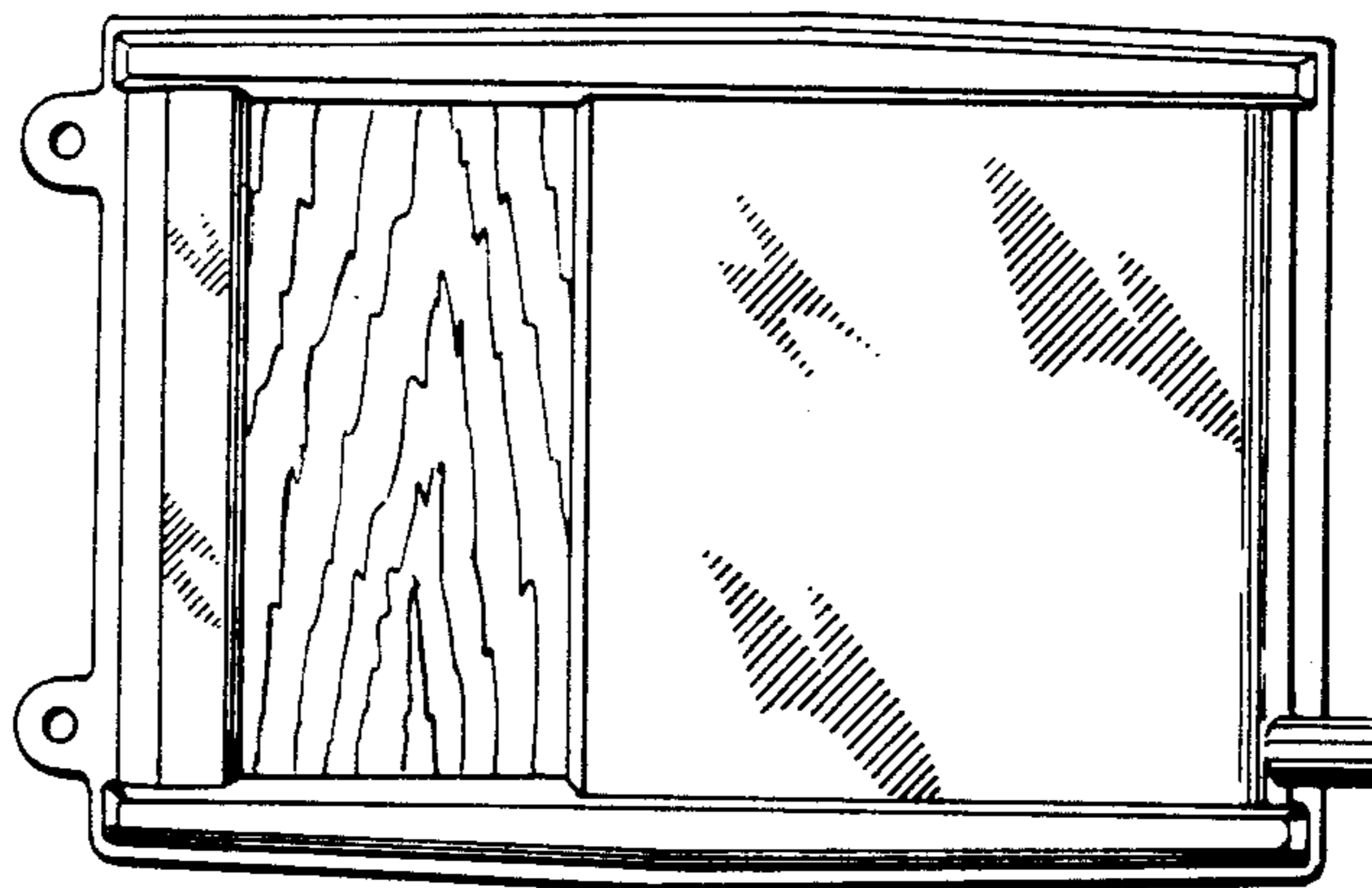

FIG. 2

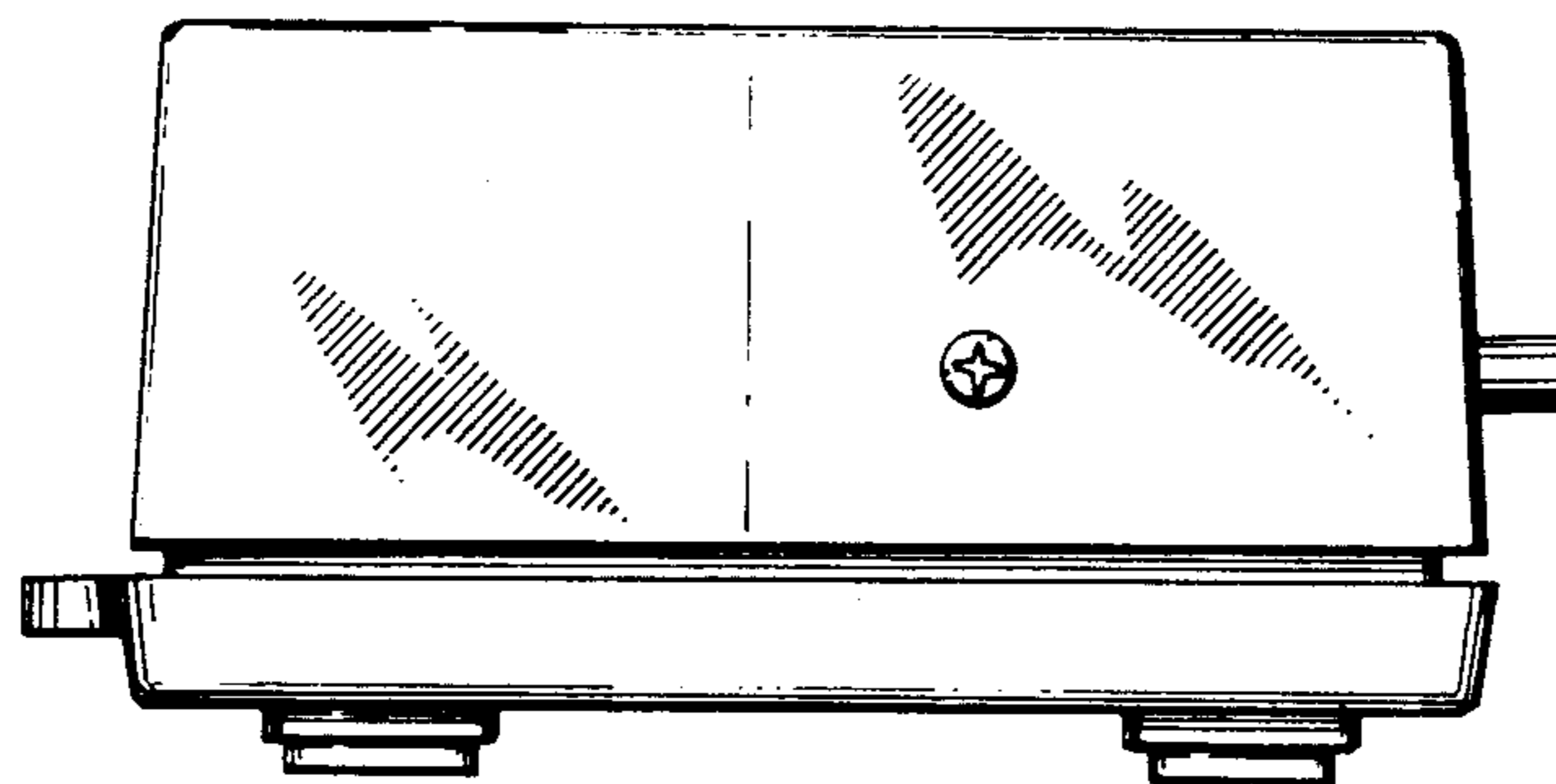

FIG. 3

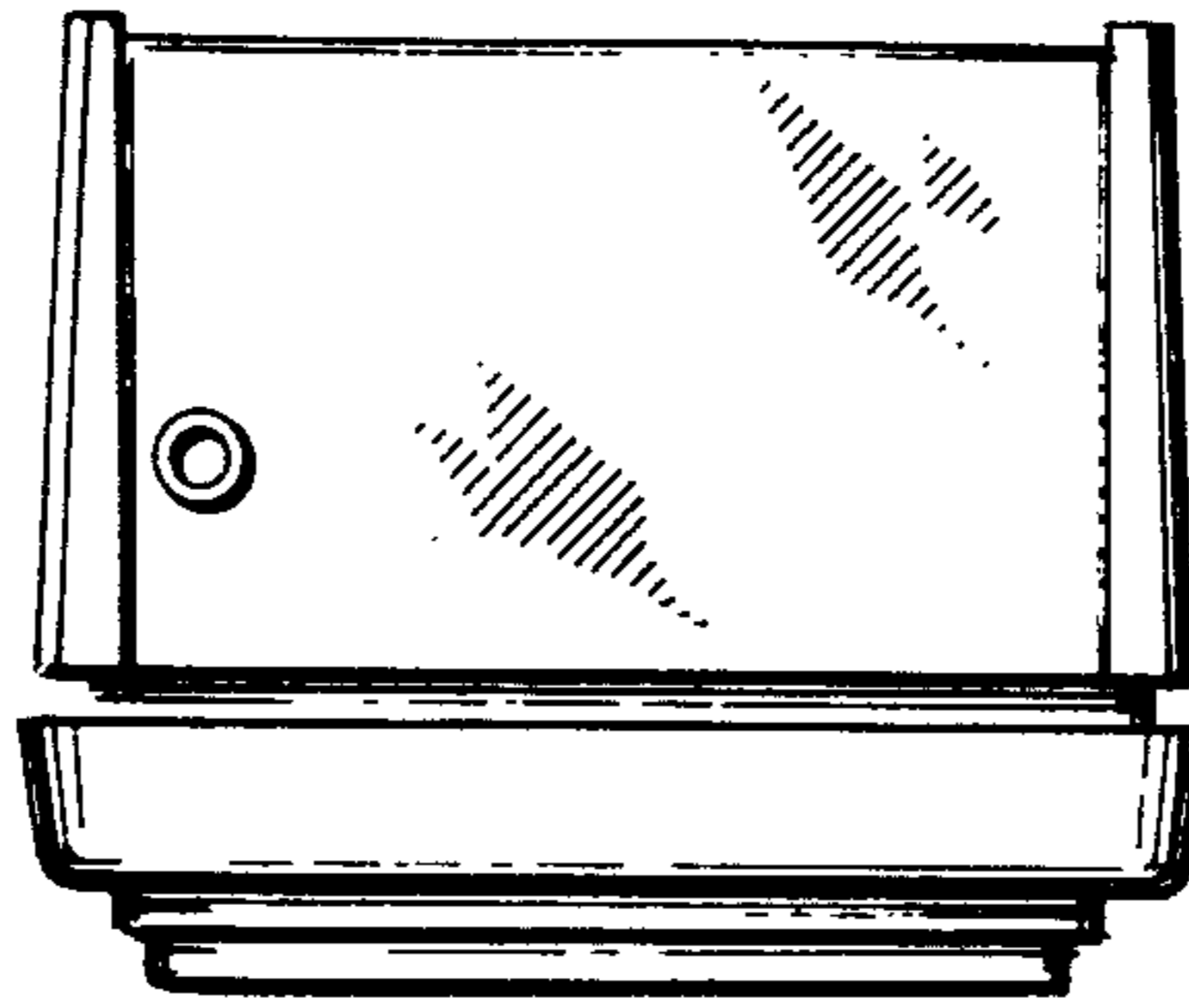

FIG. 4

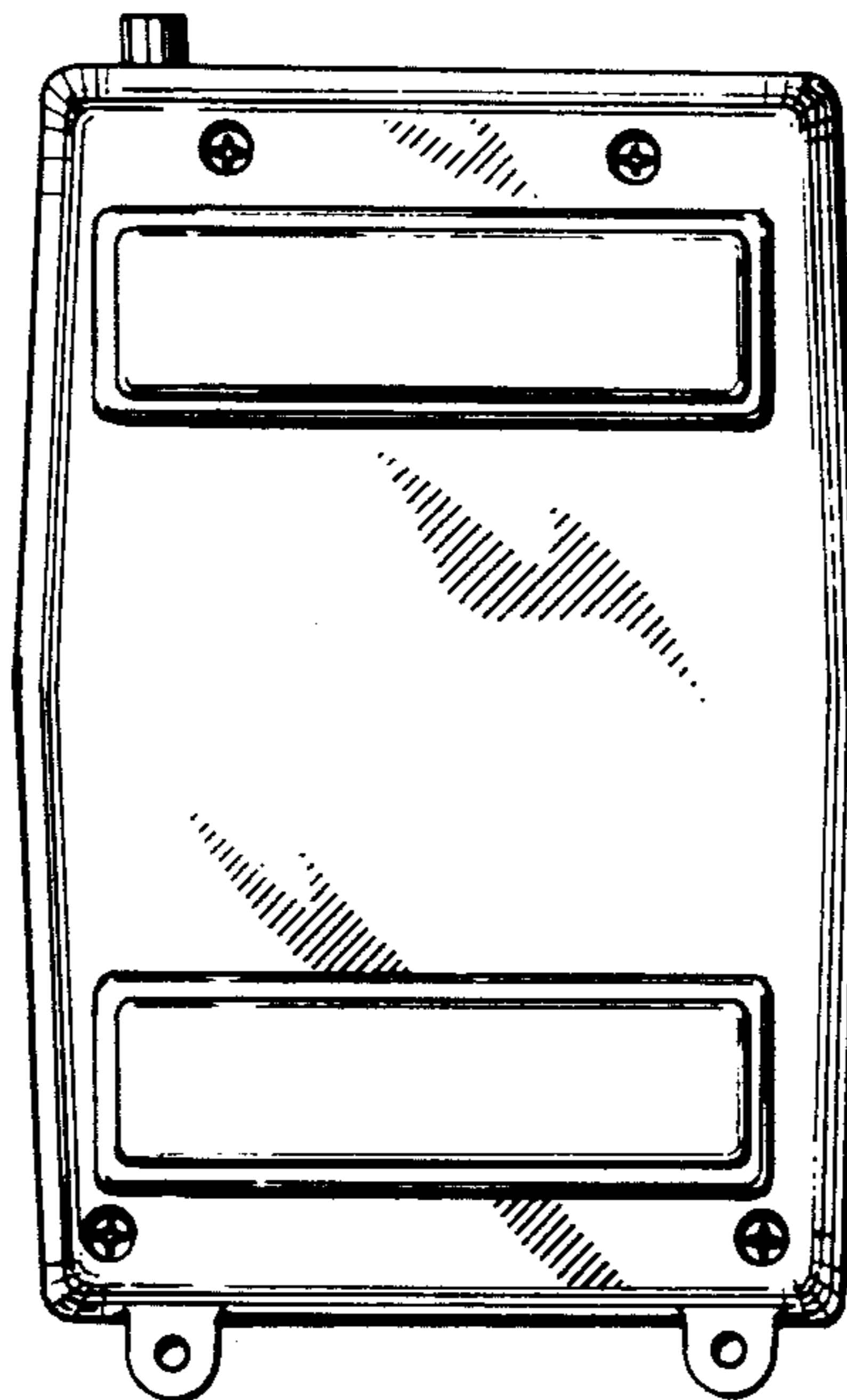

FIG. 5

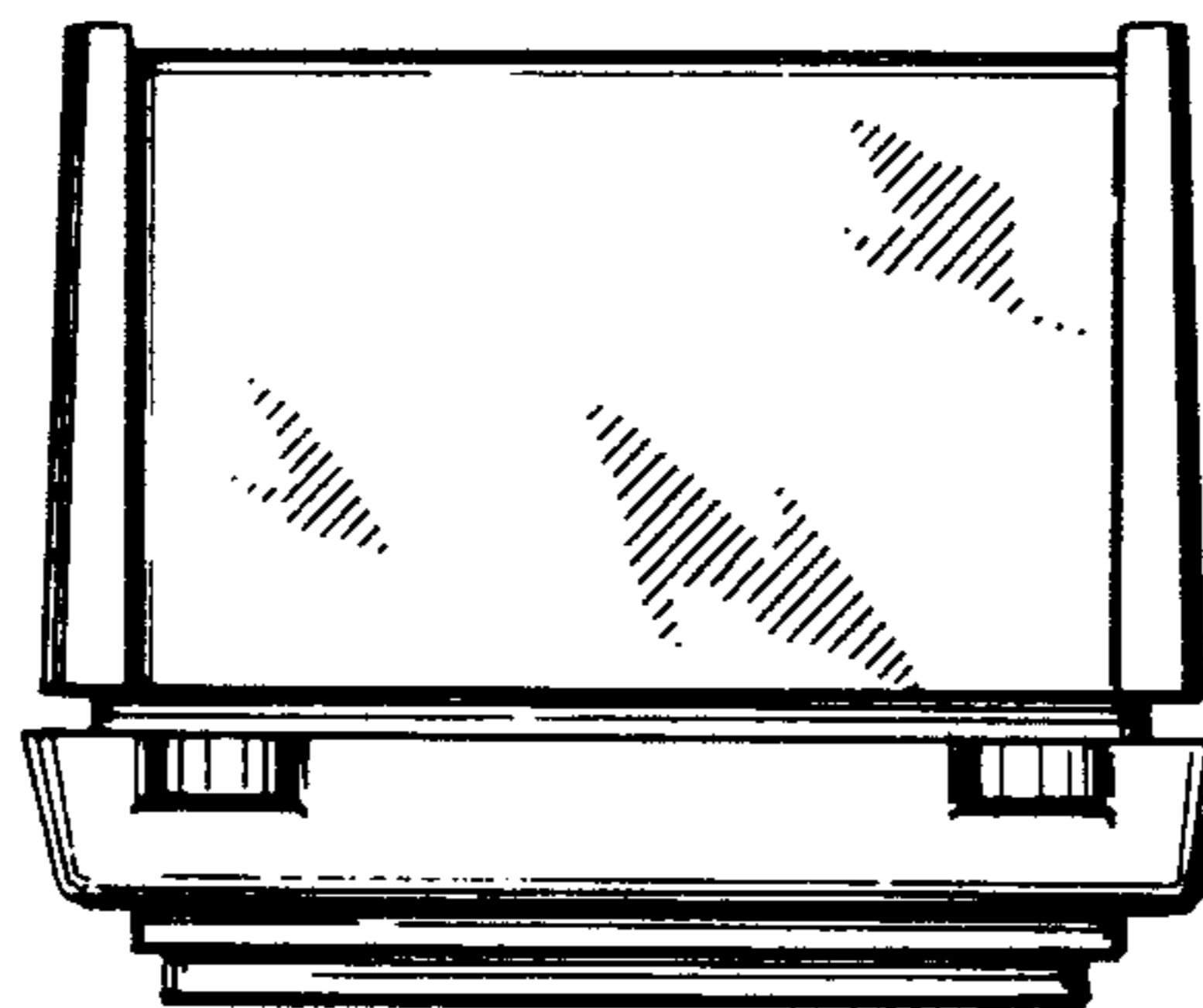

FIG. 6