

[54] COFFEEMAKER

[75] Inventor: Joseph A. Rinaldi, Oradell, N.J.

[73] Assignee: Rival Manufacturing Company, Kansas City, Mo.

[**] Term: 14 Years

[21] Appl. No.: 809,639

[22] Filed: Jun. 24, 1977

[51] Int. Cl. D7-02

[52] U.S. Cl. D7/41; D15/113

[58] Field of Search D7/59, 60, 61, 62, 63, D7/41; D15/111, 113, 112

[56] References Cited

U.S. PATENT DOCUMENTS

D. 164,554	9/1951	Dailey	D7/41 X
D. 228,053	8/1973	Knox et al.	D7/63
D. 235,015	4/1975	Stern	D7/41 X

OTHER PUBLICATIONS

Form, Jan. 1976, p. 70, Rowenta Coffee Maker at center and right.

Form, Jan. 1977, p. 42, Rowenta Coffee Maker shown.

Primary Examiner—Winifred E. Herrmann

Attorney, Agent, or Firm—Claude W. Lowe

[57] CLAIM

The ornamental design for a coffeemaker, as shown and described.

DESCRIPTION

FIG. 1 is a front perspective view of a coffeemaker showing my new design;

FIG. 2 is a left side elevational view thereof;

FIG. 3 is a right side elevational view thereof;

FIG. 4 is a top plan view thereof;

FIG. 5 is a front elevational view thereof; and

FIG. 6 is a rear elevational view thereof.

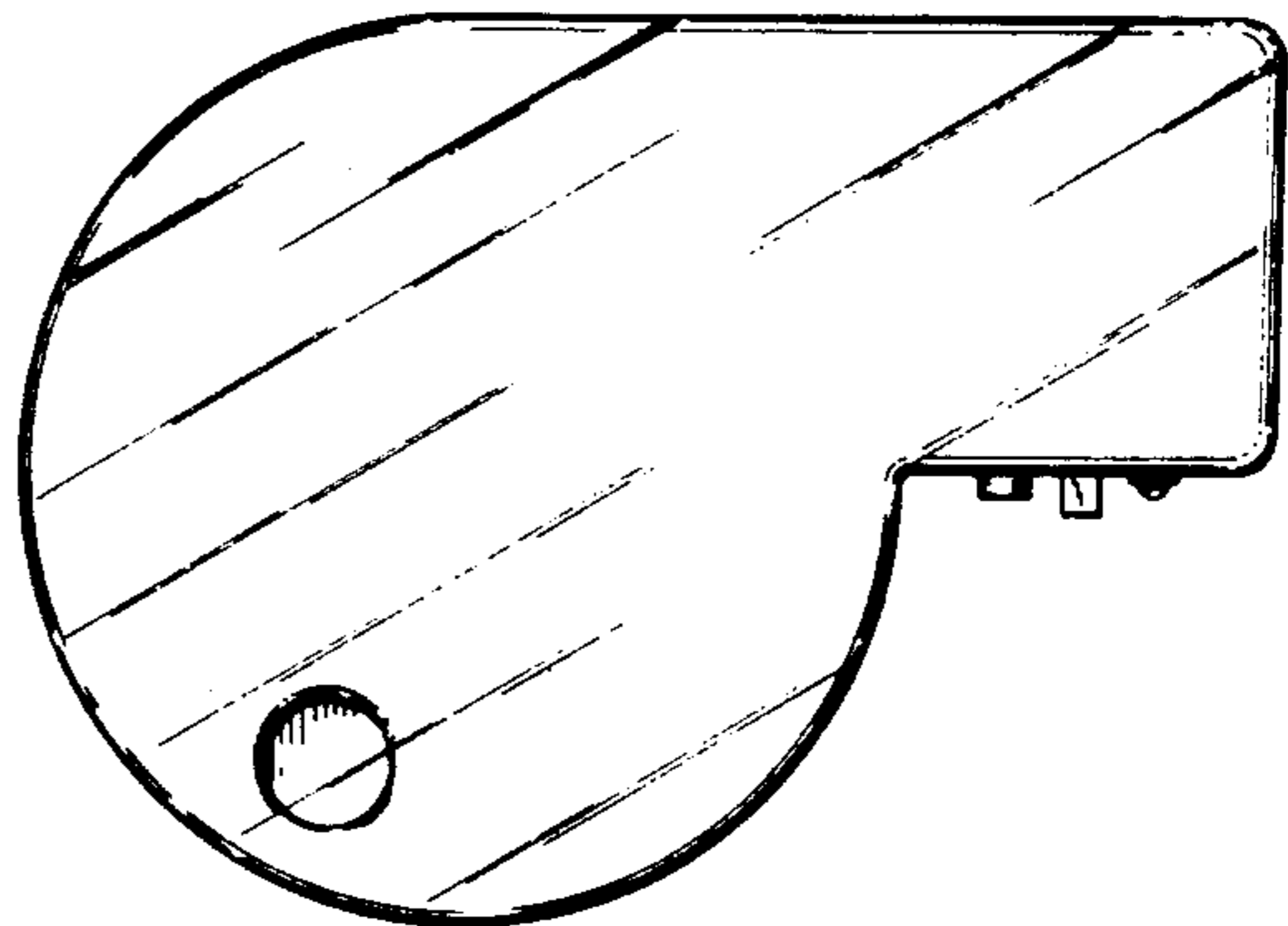
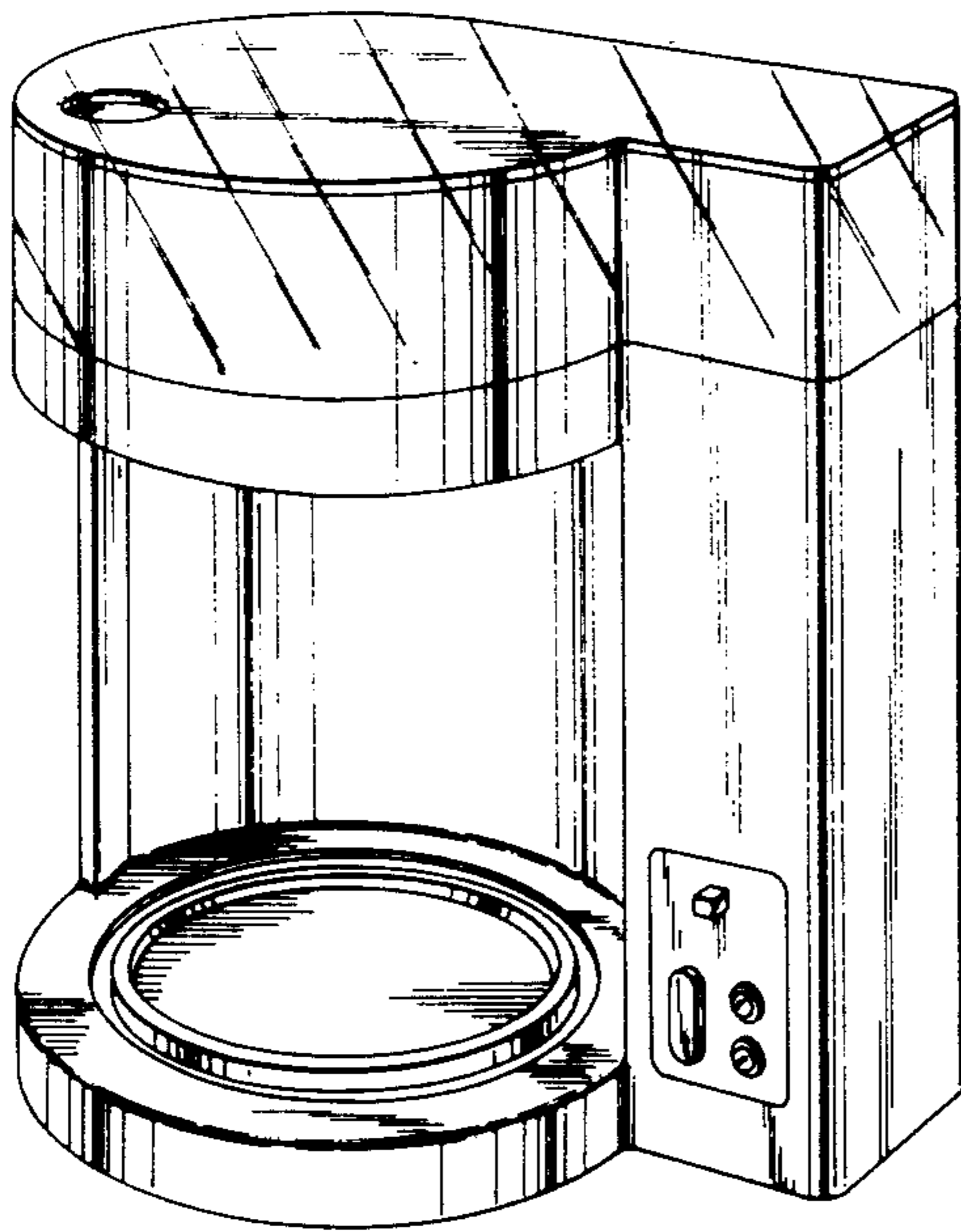

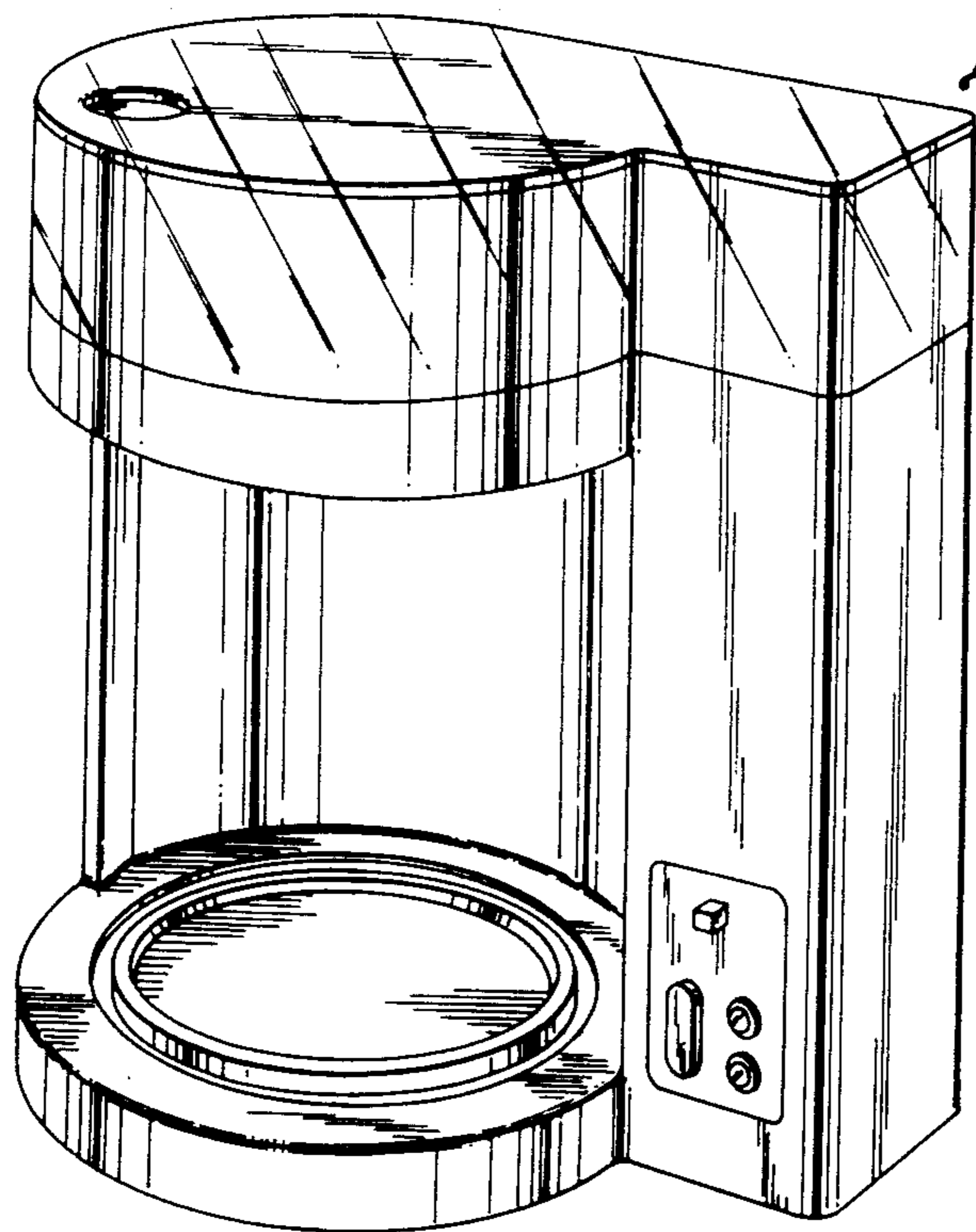

Fig. 1.

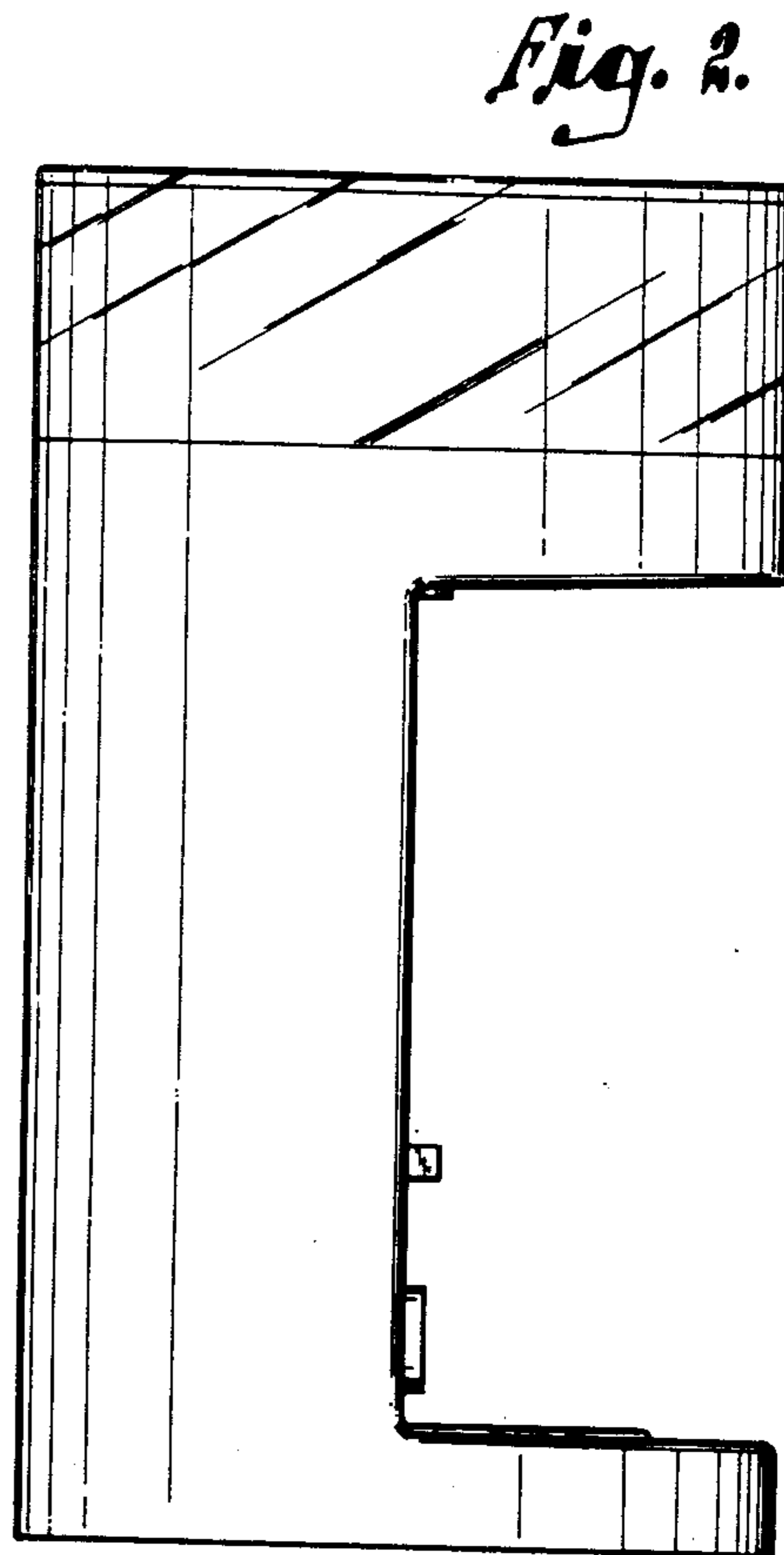

Fig. 2.

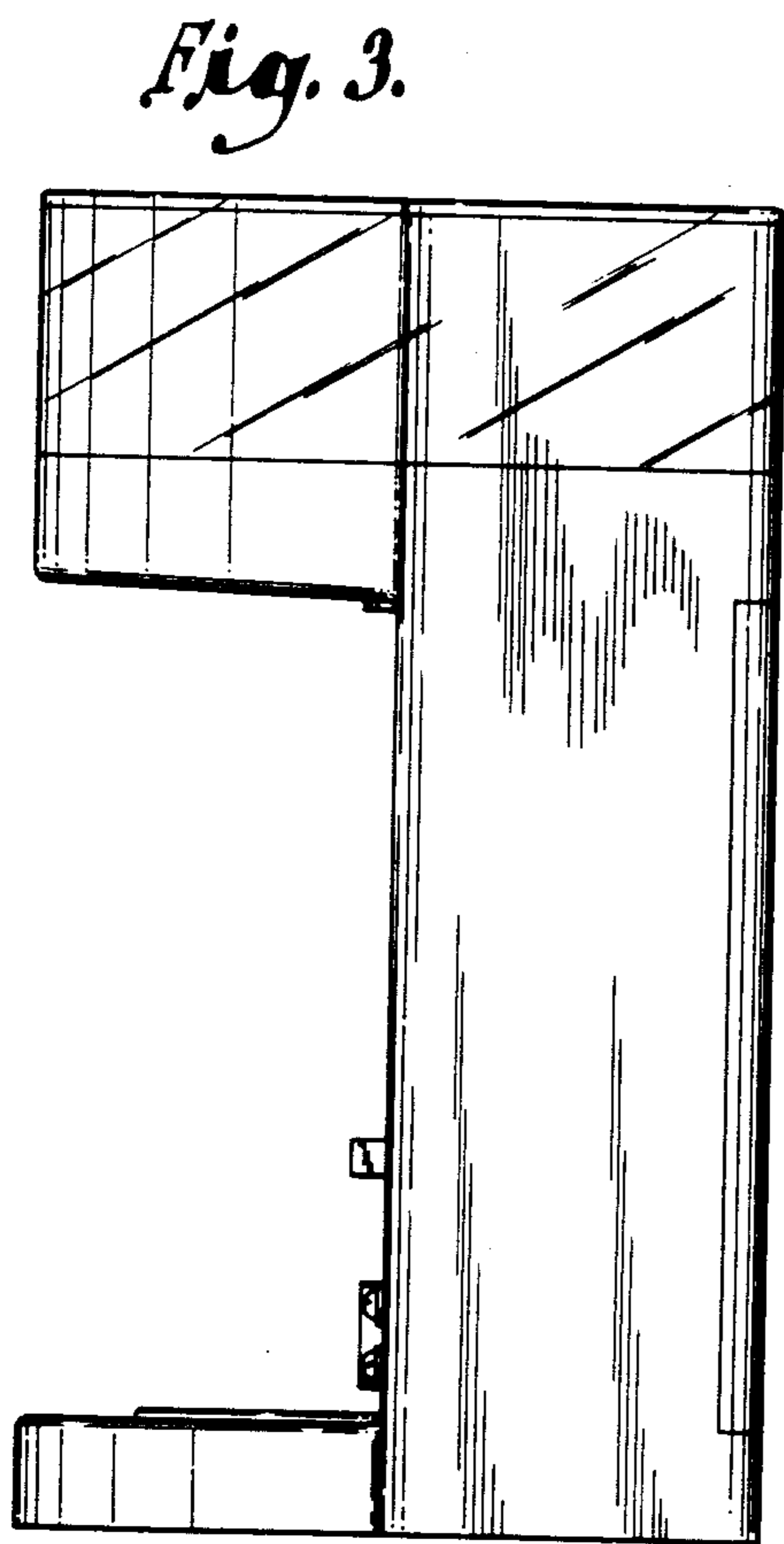

Fig. 3.

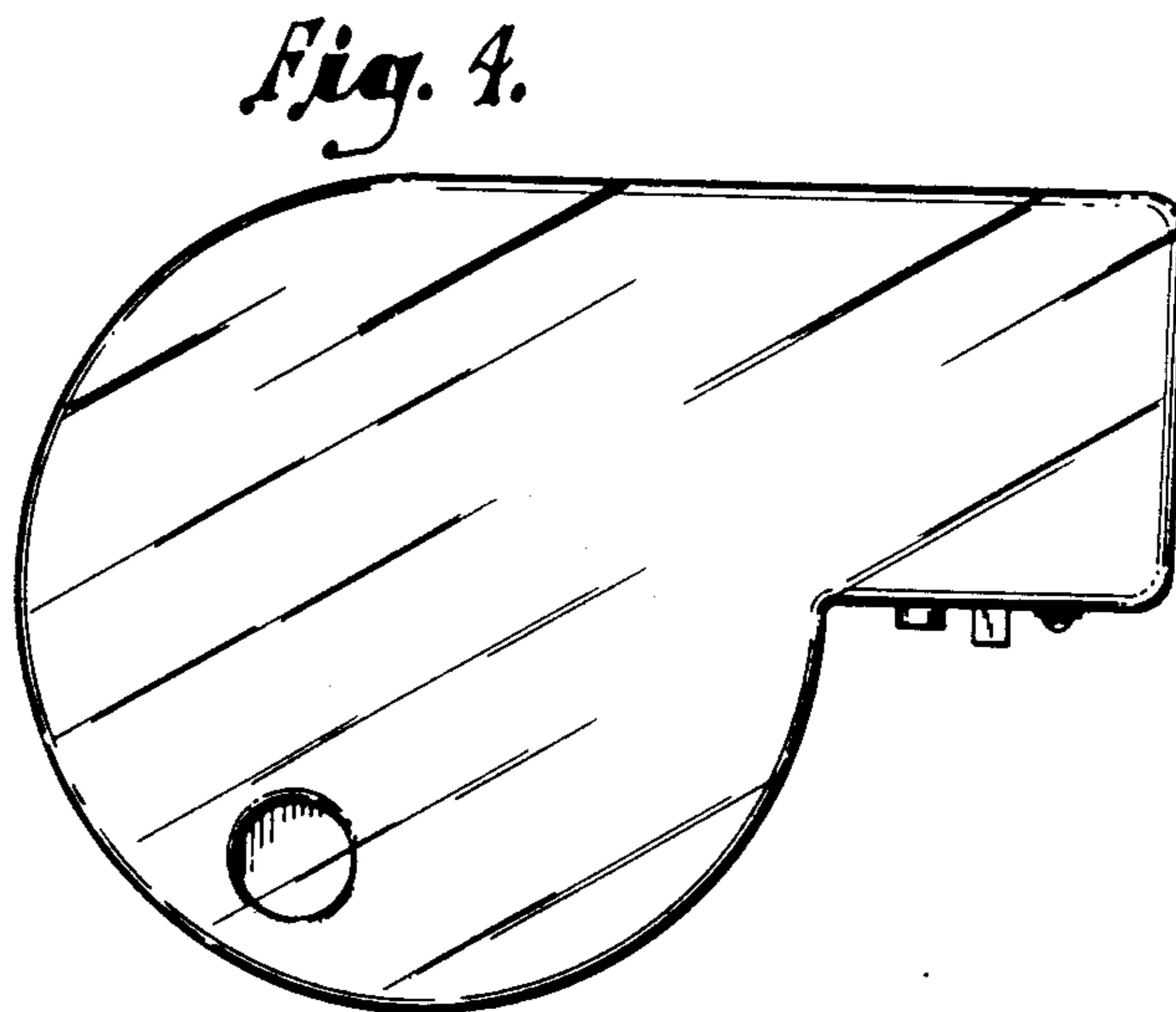

Fig. 4.

Fig. 5.

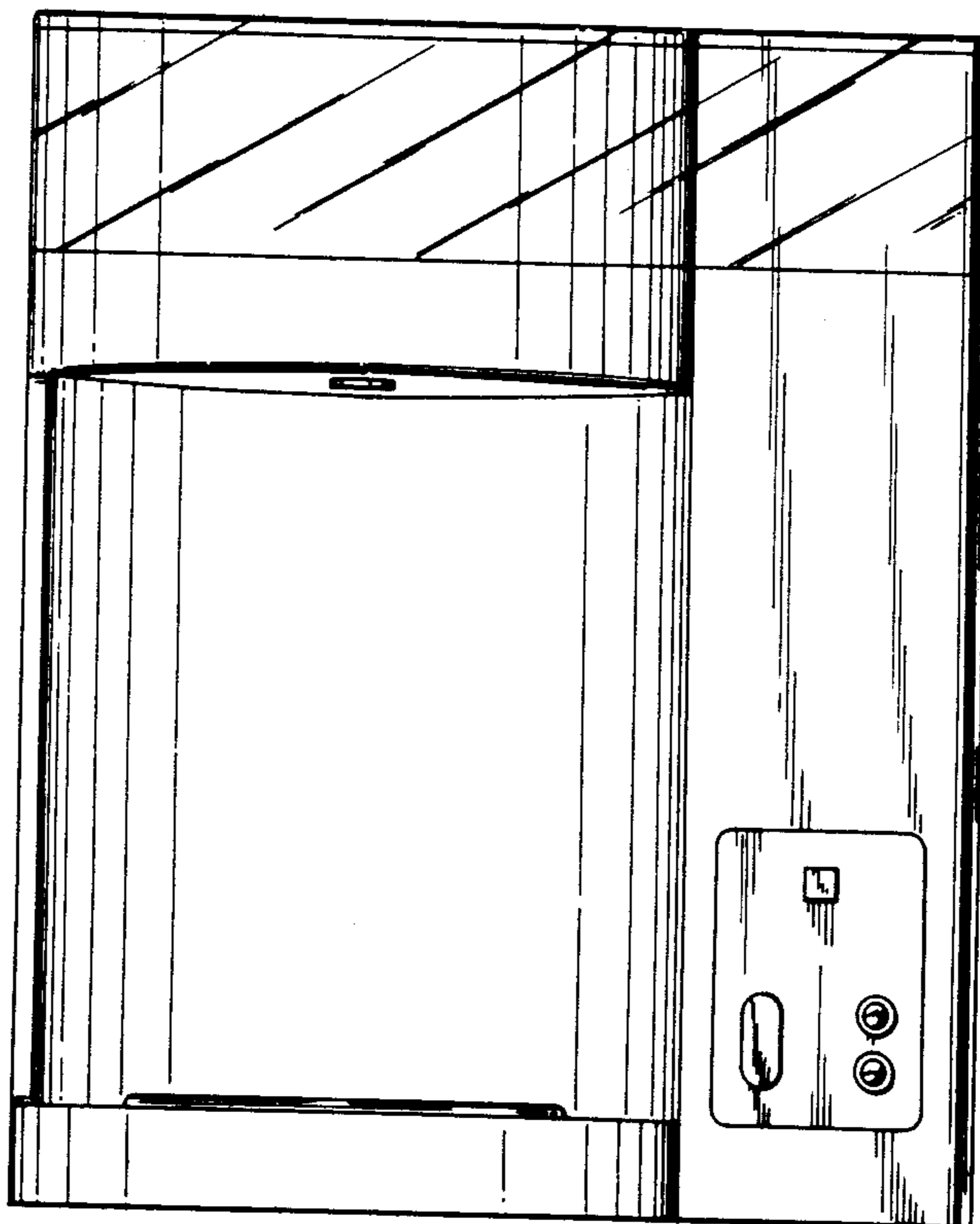

Fig. 6.

