

[54] DENTAL MIXING SLAB

[76] Inventor: **Thomas J. Mayclin**, 2629 Louisiana Ave., Minneapolis, Minn. 55426

[**] Term: **14 Years**

[21] Appl. No.: **808,913**

[22] Filed: **Jun. 22, 1977**

[51] Int. Cl. **D24-02**

[52] U.S. Cl. **D24/10; 433/49**

[58] Field of Search **206/562, 563, 564, 557; 32/39, 40, 71; D24/10, 99, 56**

[56] **References Cited**

U.S. PATENT DOCUMENTS

D. 89,954	5/1933	Grier	D24/10
D. 209,584	12/1967	Towe	D24/10
1,896,772	2/1933	Drespel	32/39
2,492,479	12/1949	Howard	32/39 X

OTHER PUBLICATIONS

Dixon Dental Tools, Cat. ©1954, p. 546, Porcelain Mixing Tablet.

Primary Examiner—Bernard Ansher
Attorney, Agent, or Firm—George F. Williamson

[57] **CLAIM**

The ornamental designs for dental mixing slab, as shown and described.

DESCRIPTION

FIG. 1 is a perspective view of a dental mixing slab embodying the novel design,

FIG. 2 is a top plan view thereof;

FIG. 3 is a side elevational view thereof, the other side being identical in appearance;

FIG. 4 is an end elevational view thereof, the opposite end thereof being identical in appearance;

FIG. 5 is a perspective view of a modified form of the dental mixing slab embodying the novel design;

FIG. 6 is a top plan view of the dental mixing slab illustrated in FIG. 5;

FIG. 7 is a side elevational view thereof, the opposite side being identical in appearance; and

FIG. 8 is an end view thereof, the opposite end thereof being identical in appearance.

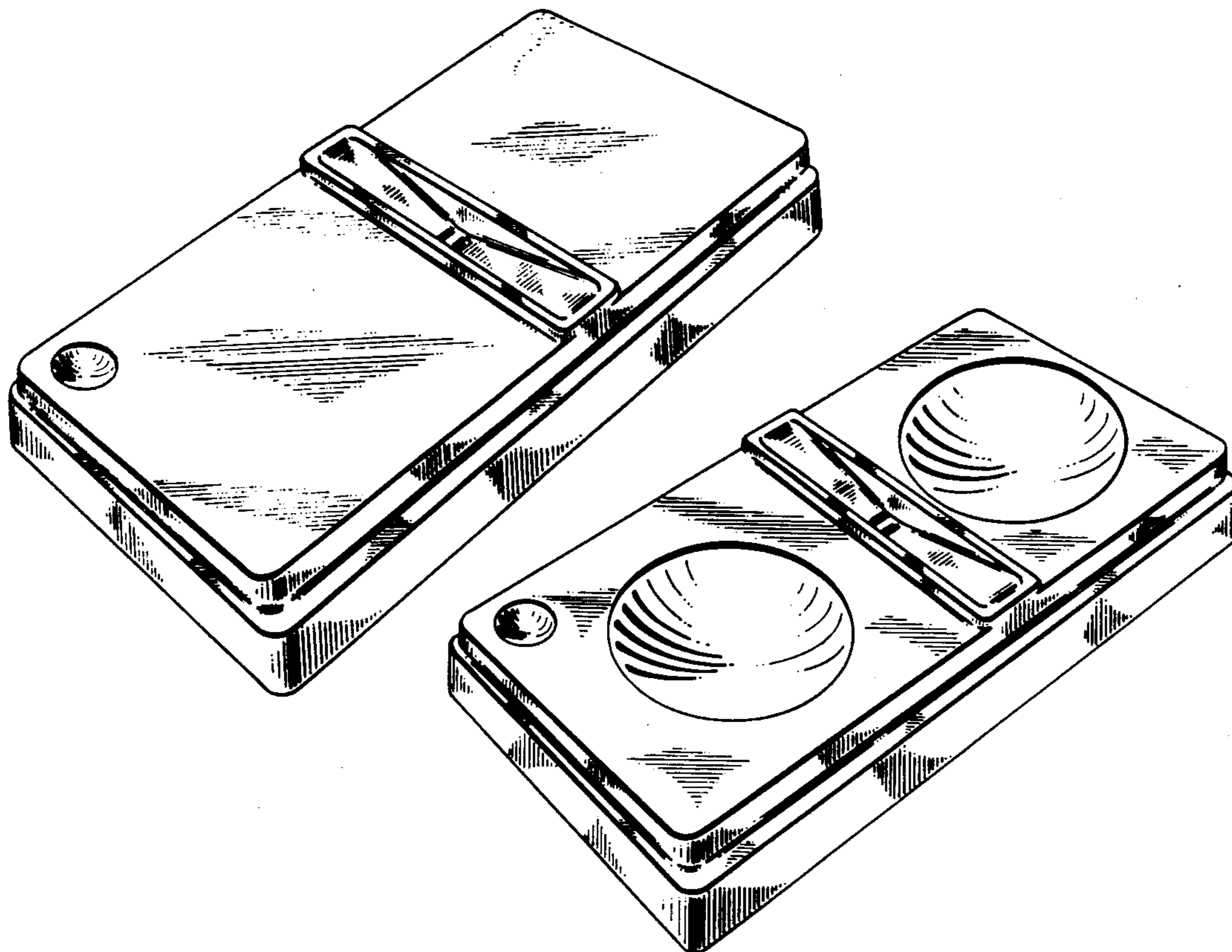

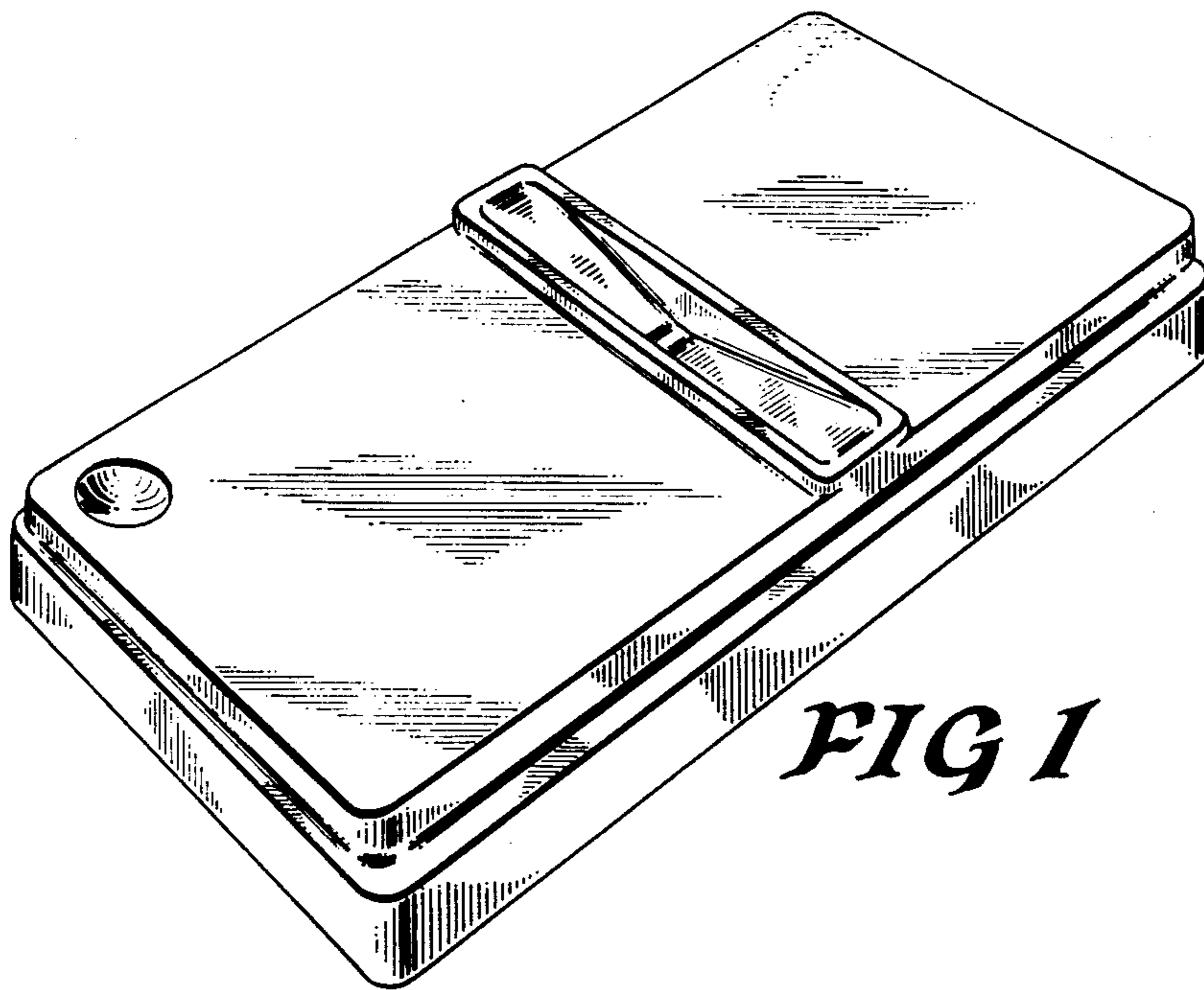

FIG 1

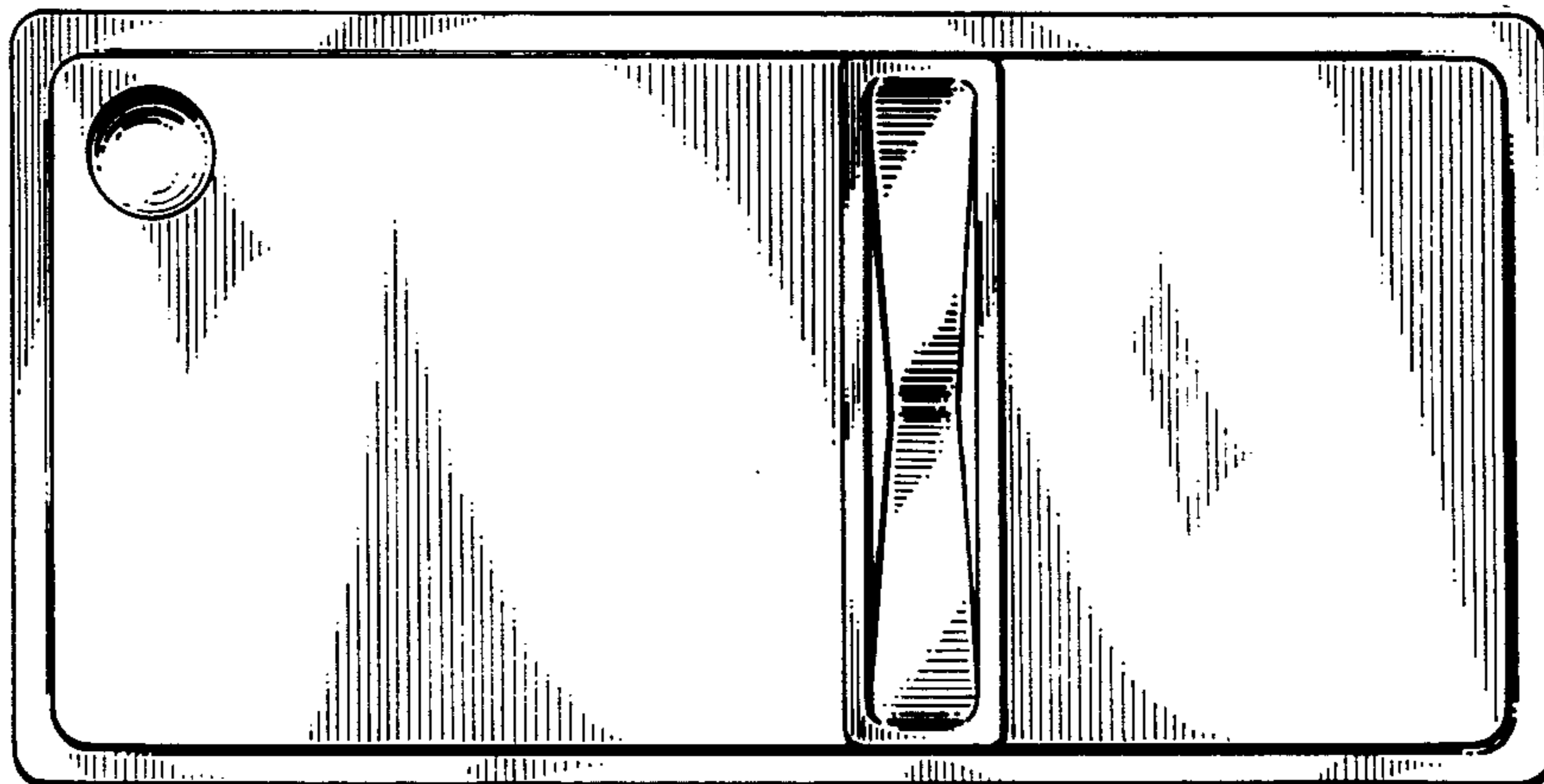

FIG 2



FIG 3

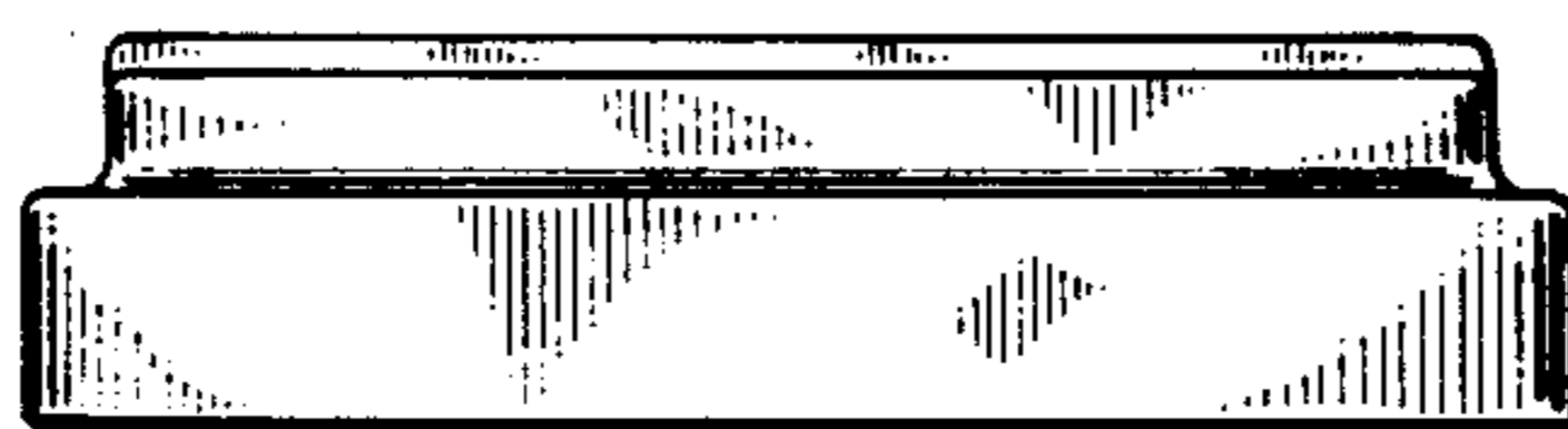

FIG 4

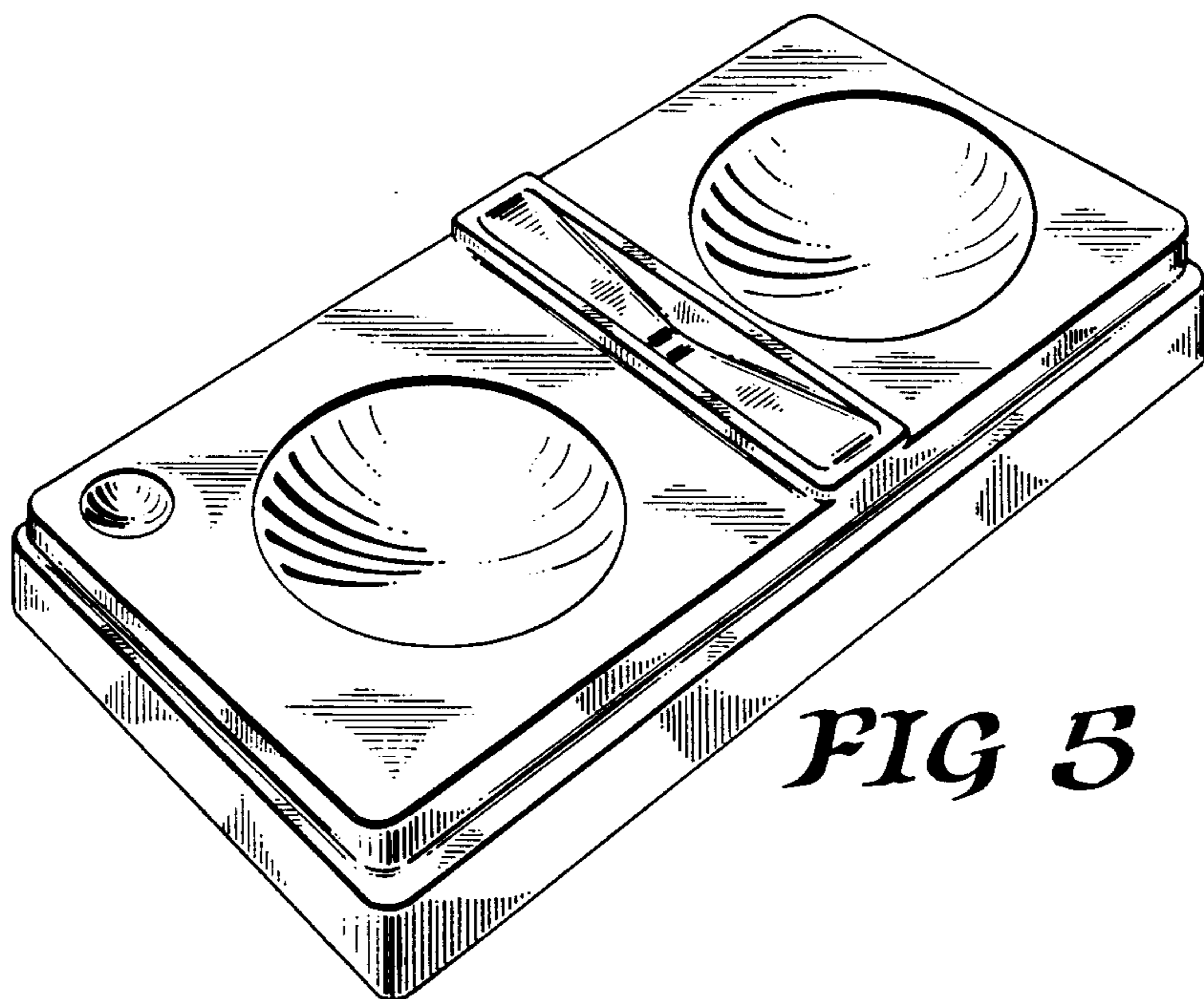

FIG 5

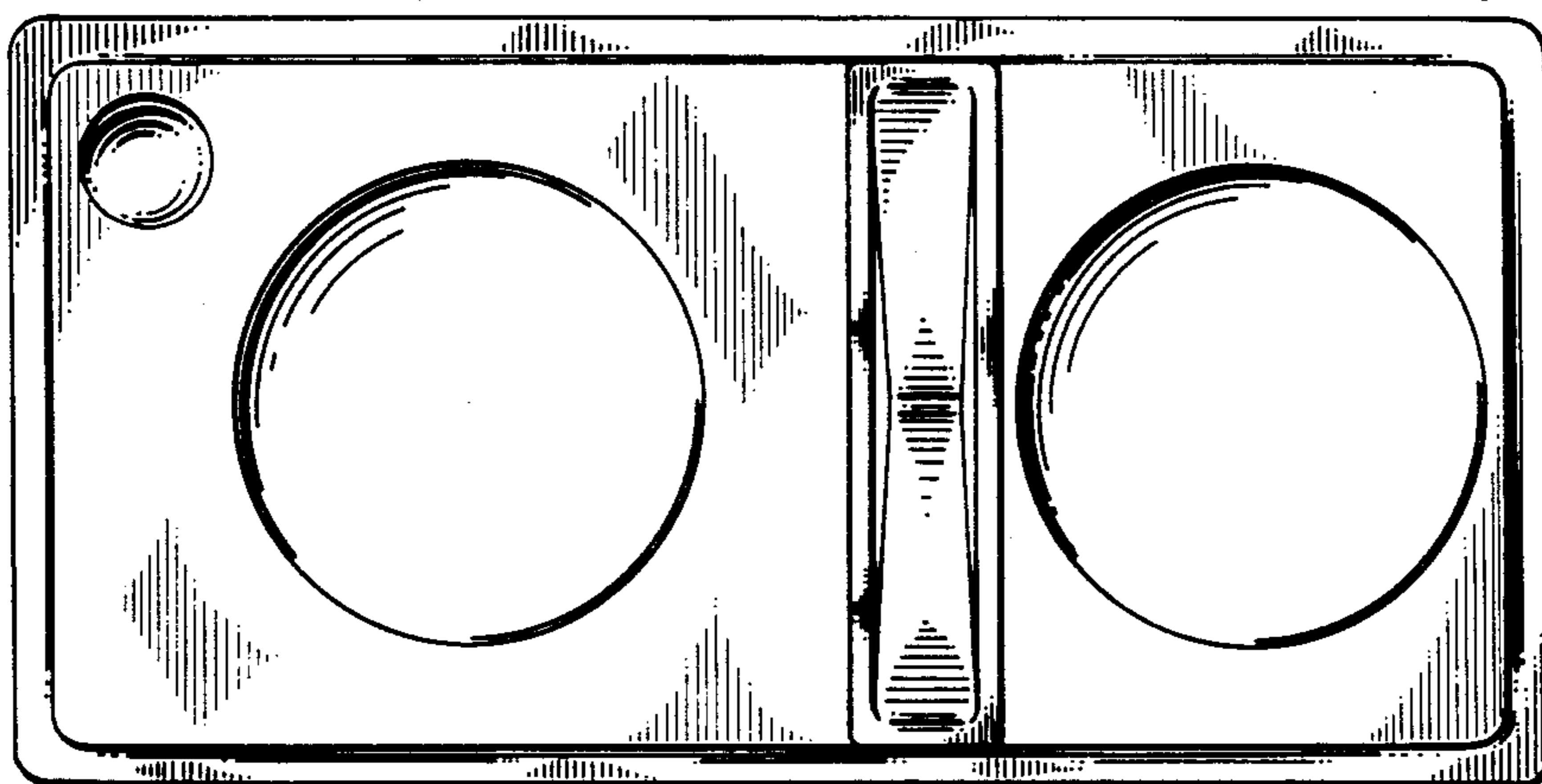

FIG 6

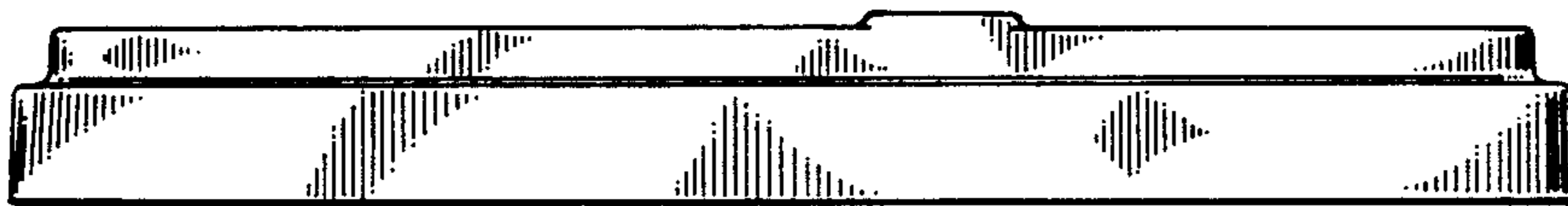

FIG 7

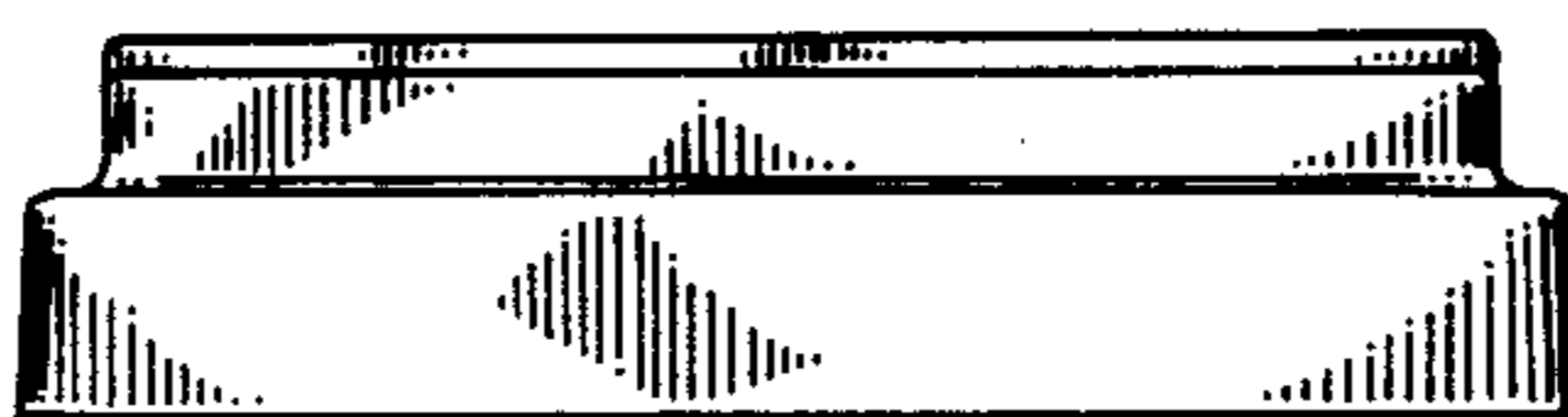

FIG 8