

[54] BOWL

[76] Inventor: Sharon Ottier, 15 Wray Ct., Rexdale, Ontario, Canada

[**] Term: 14 Years

[21] Appl. No.: 898,497

[22] Filed: Apr. 20, 1978

[51] Int. Cl. D7-02

[52] U.S. Cl. D7/97; D7/43

[58] Field of Search D7/43, 85, 97, 20, 21, D7/96, 27, 23; D9/220

[56] References Cited

U.S. PATENT DOCUMENTS

2,290,396	7/1942	Webster	D7/43 X
3,182,397	5/1965	Entenmann	D7/43 X
3,360,153	12/1967	Wheaton, Jr.	D7/17 X

OTHER PUBLICATIONS

Retailing Home Furnishings, Sec. 3, Jan. 16, 1978, p. 14, Eagle Micromasters, top right handled baking ring. LaLance & Grosjean Mfg. Co., Cooking and Sanitary Wares, 7-1-1922, p. 73-E, Round Cake Pan/Tube, middle item.

Primary Examiner—Winifred E. Herrmann
Attorney, Agent, or Firm—Donald E. Hewson

[57] CLAIM

The ornamental design for a bowl, as shown and described.

DESCRIPTION

FIG. 1 is a top front perspective view of a bowl showing my new design;
FIG. 2 is a bottom rear perspective view thereof;
FIG. 3 is a cross section in the direction of arrows 3—3 in FIG. 1;
FIG. 4 is a cross section in the direction of arrows 4—4 in FIG. 1; and,
FIG. 5 is a plan view, from below, of a bowl showing my new design.

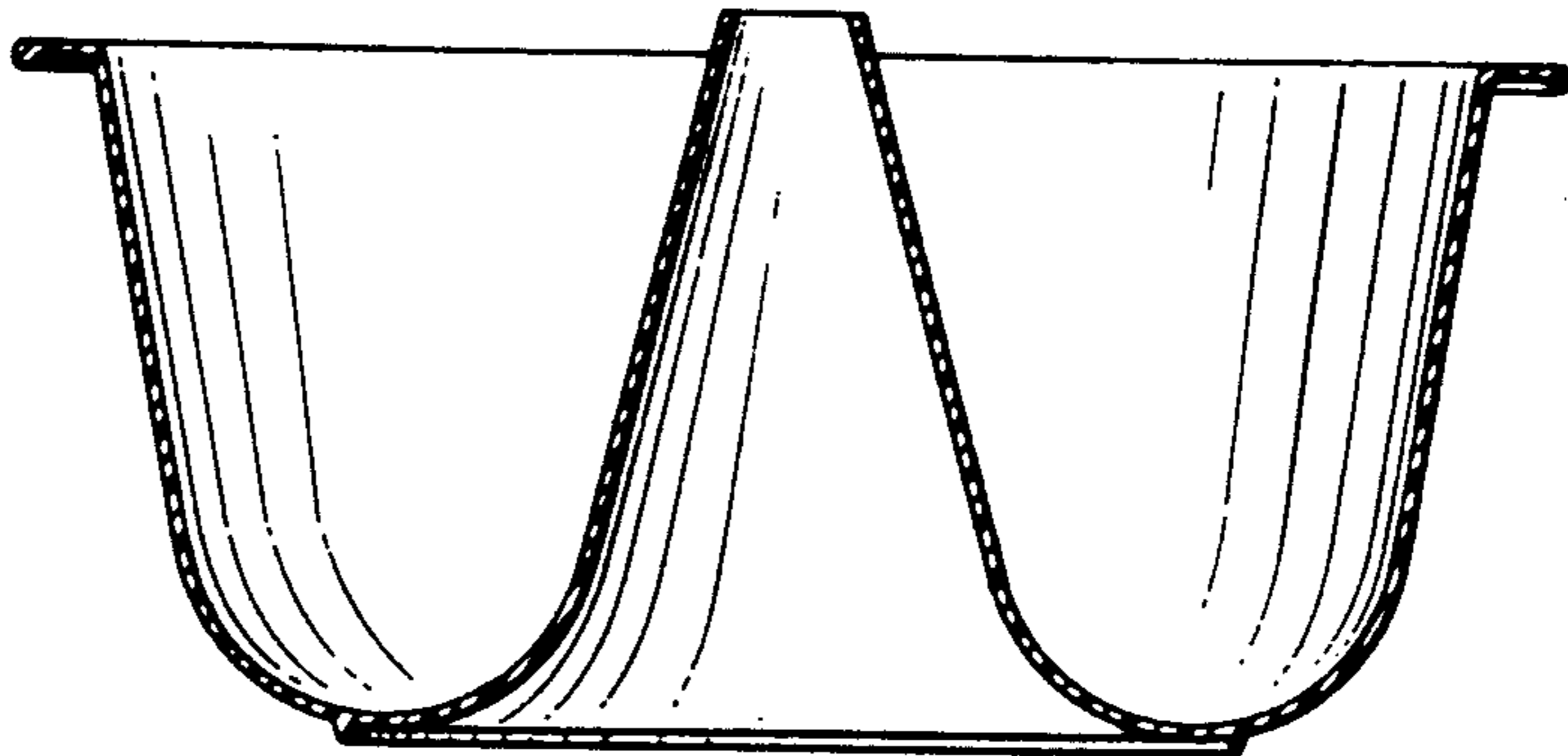
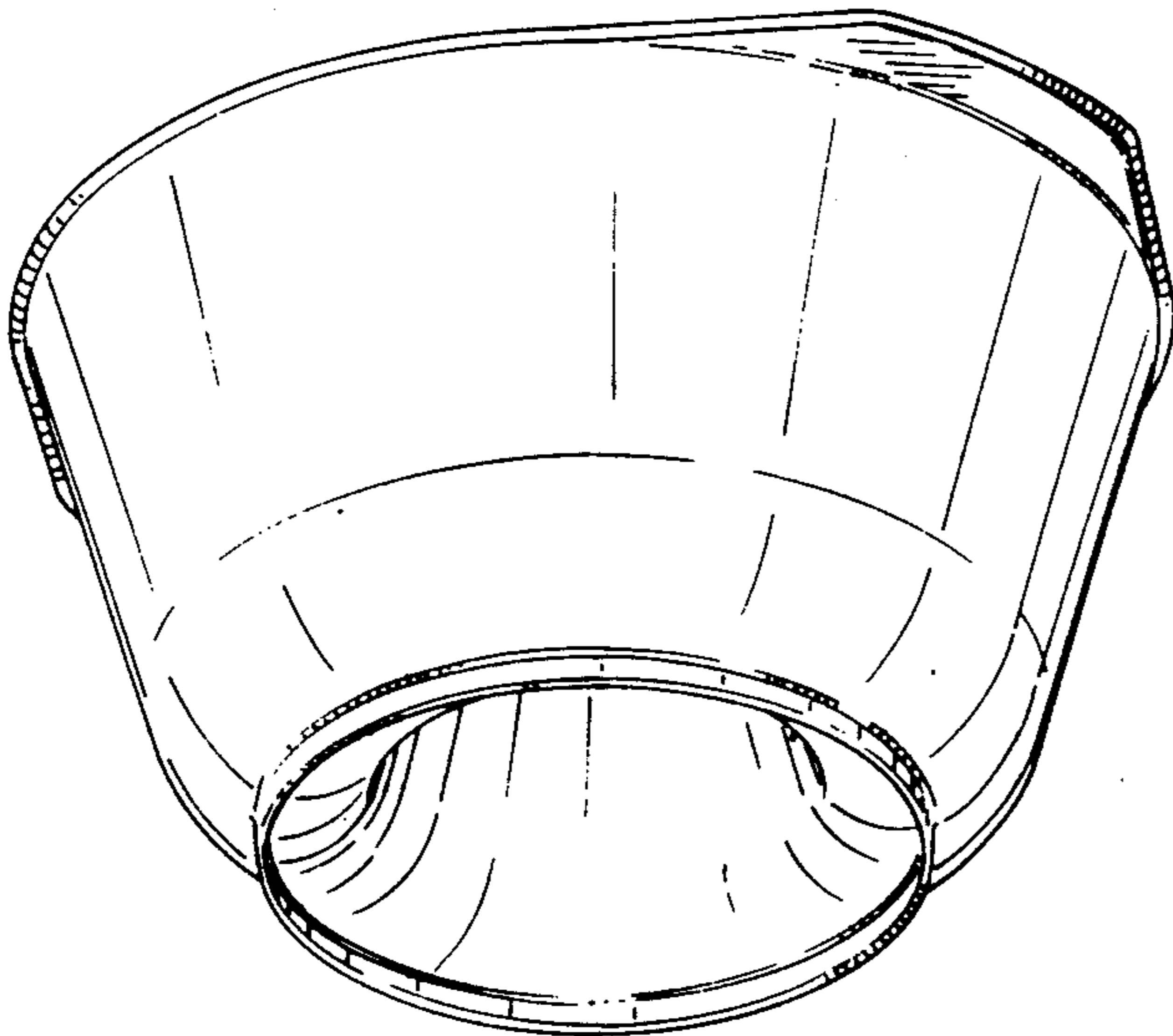

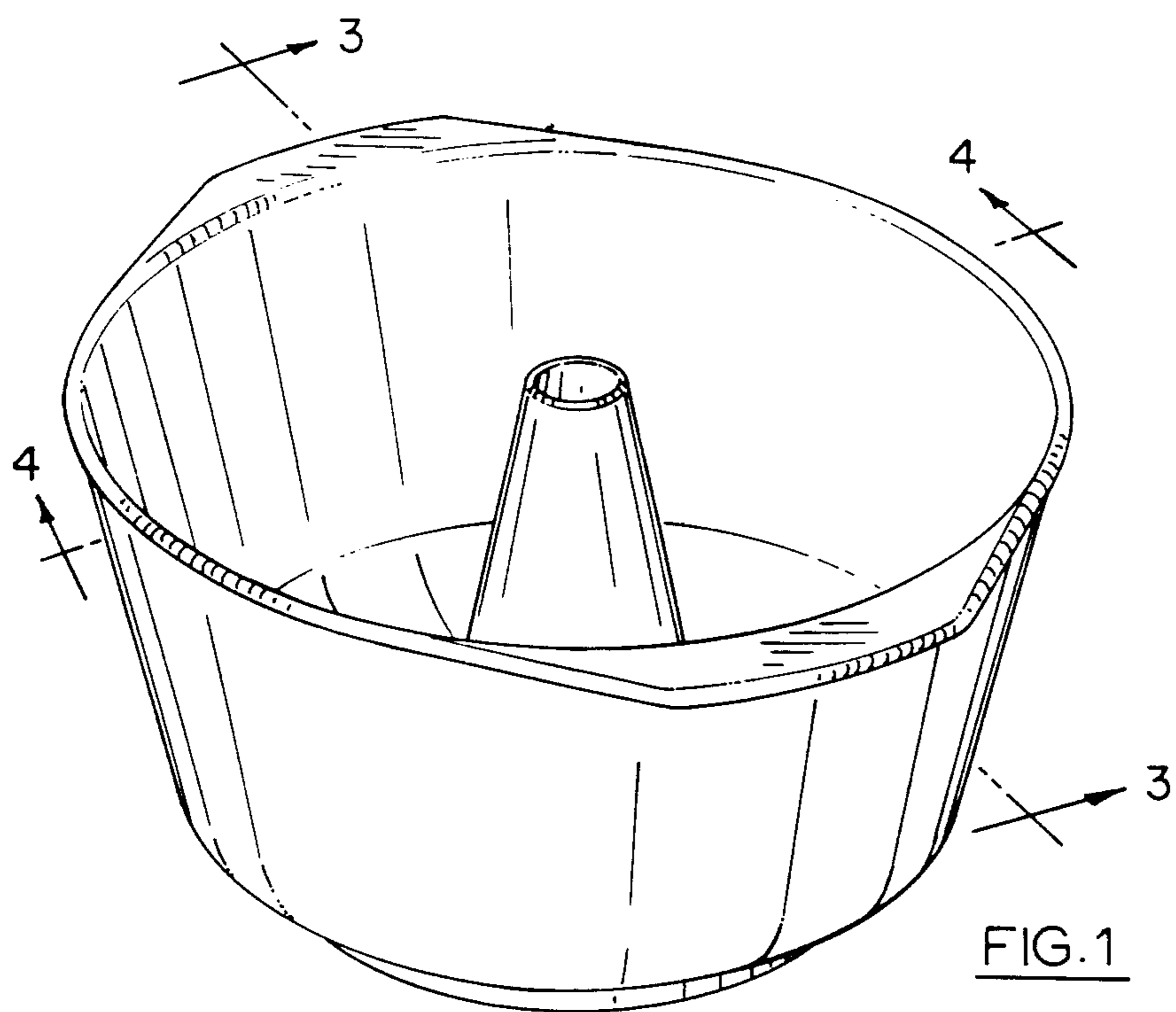
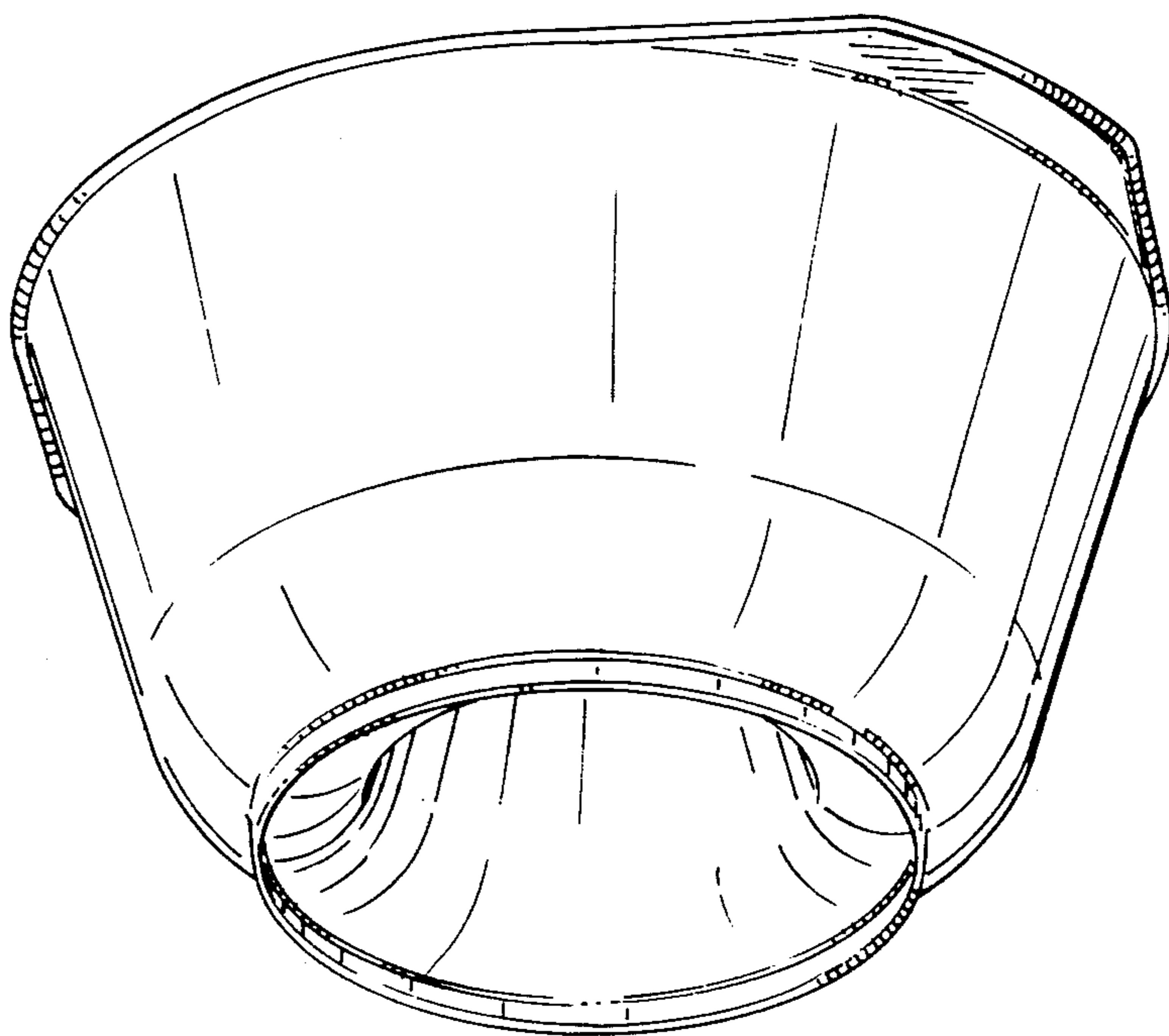

FIG. 2



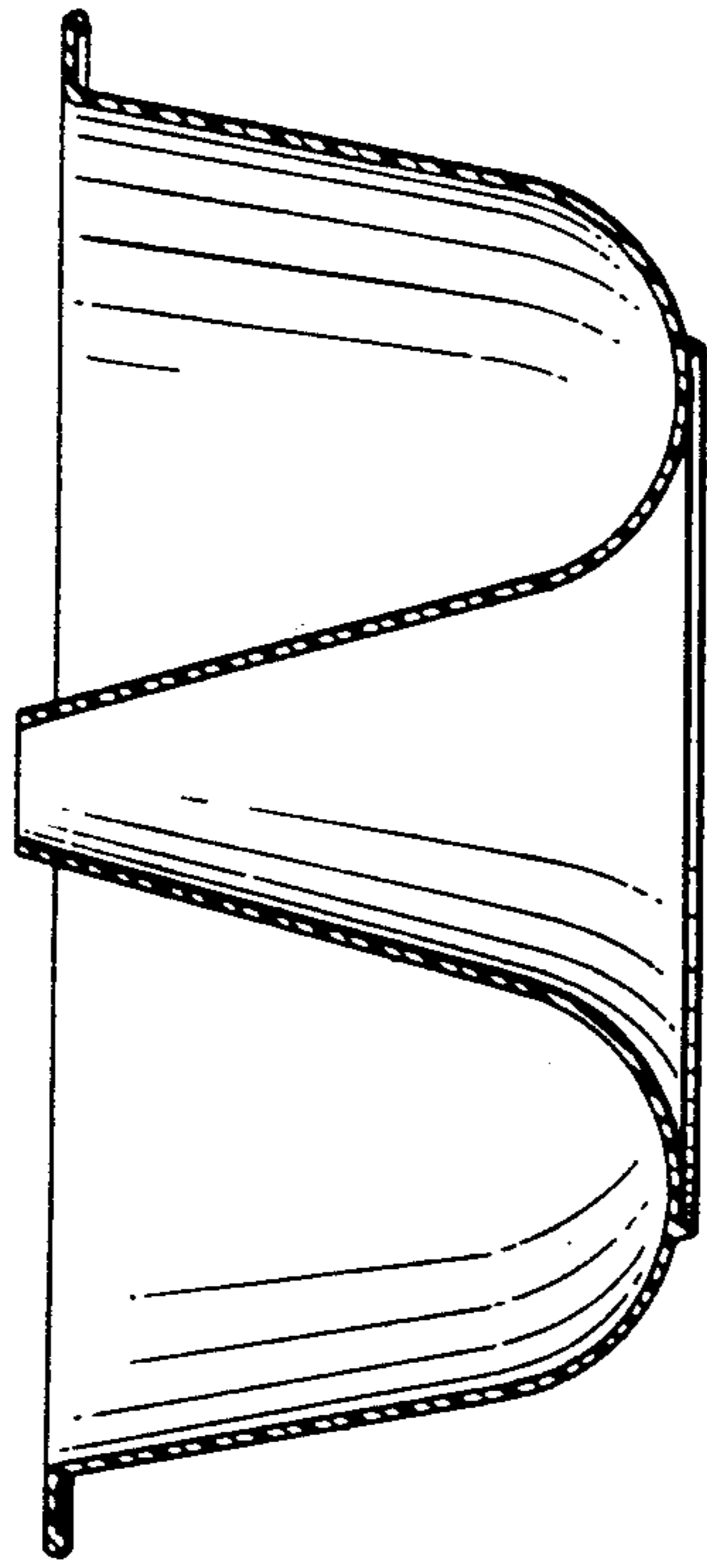

FIG. 3

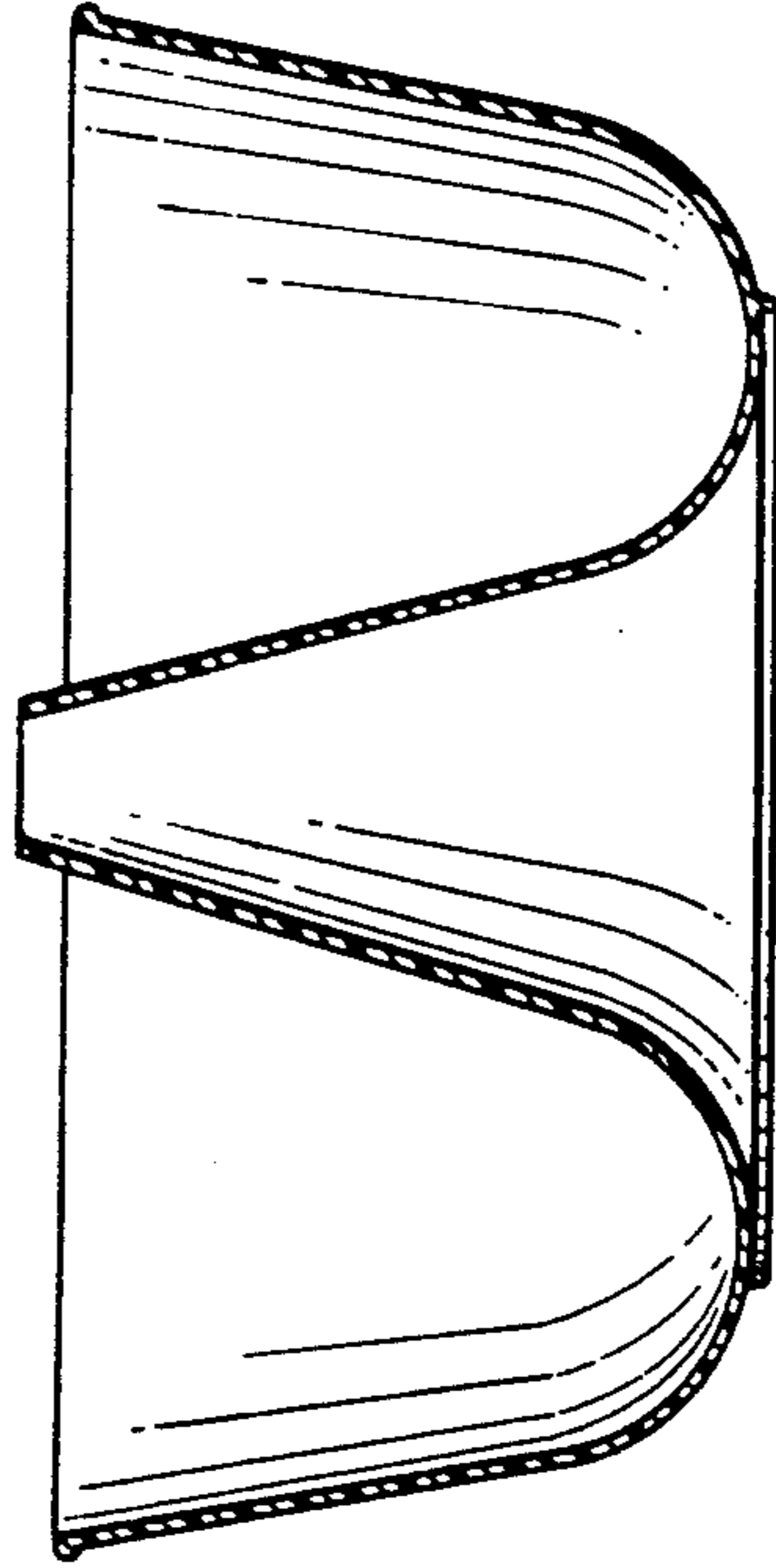

FIG. 4

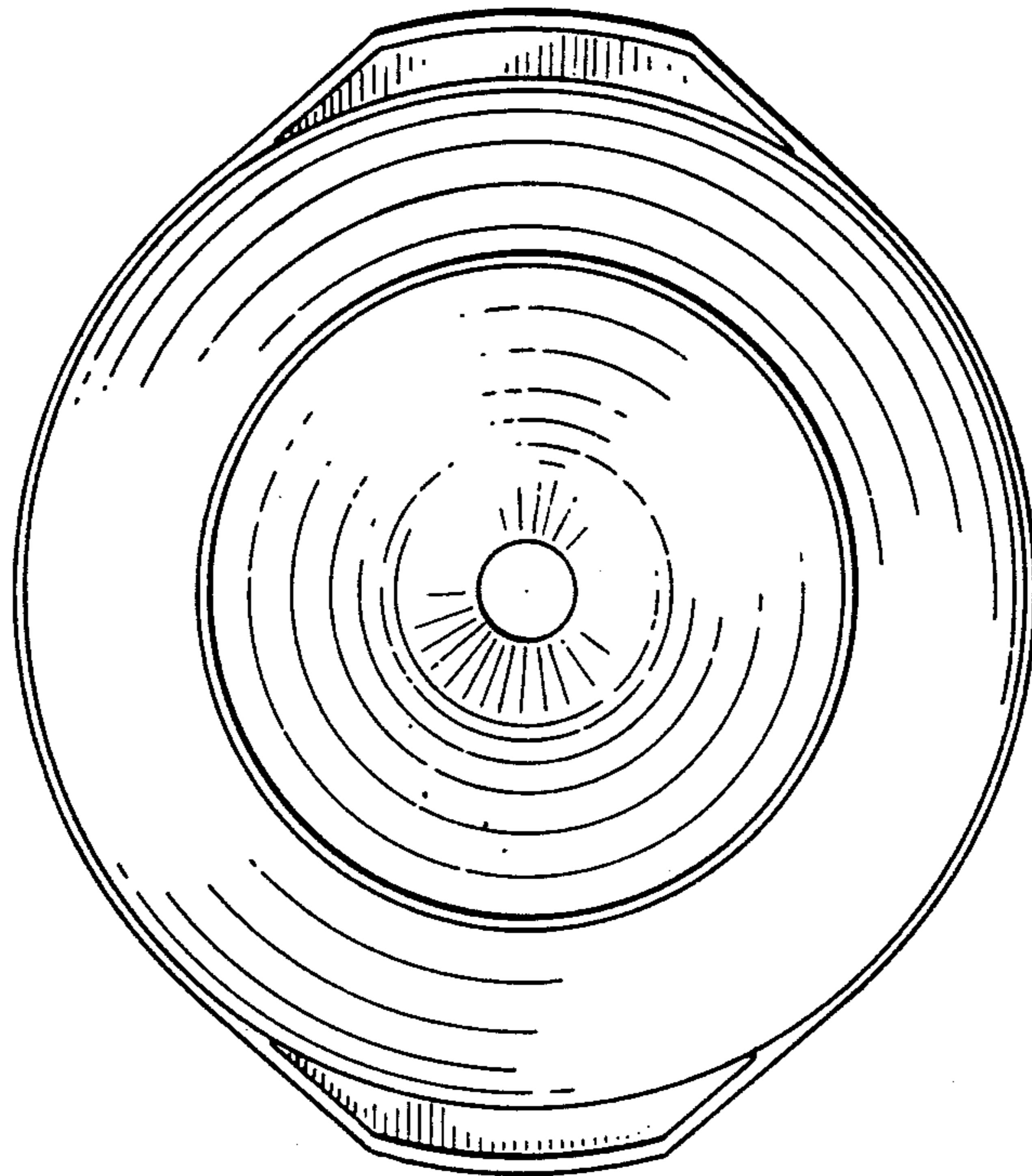

FIG. 5