

[54] COMBINED DRAFTING PEN HOLDER AND CONTAINER

[75] Inventor: Gerold Anderka, Ellerbek, Fed. Rep. of Germany

[73] Assignee: Koh-I-Noor Rapidograph, Inc., Bloomsbury, N.J.

[**] Term: 14 Years

[21] Appl. No.: 811,930

[22] Filed: Jun. 30, 1977

[51] Int. Cl. D19-06

[52] U.S. Cl. D19/85

[58] Field of Search D87/11 R; D19/65, 75, D19/77, 81, 83-85; 206/45.18, 214, 379; 211/69.1, 99, 69.5-69.8

[56] References Cited

U.S. PATENT DOCUMENTS

D. 227,080	6/1973	Poisson	D9/186
3,786,915	1/1974	Potts	206/45.18
3,862,683	1/1975	Koelichen	211/69.5

FOREIGN PATENT DOCUMENTS

817265	10/1951	Fed. Rep. of Germany	206/214
2358900	6/1975	Fed. Rep. of Germany	206/214
60943	3/1968	German Democratic Rep.	206/214

Primary Examiner—Joel Stearman
Assistant Examiner—George P. Word
Attorney, Agent, or Firm—David H. Semmes

[57] CLAIM

The ornamental design for a combined drafting pen holder and container, as shown and described.

DESCRIPTION

FIG. 1 is a perspective view of a combined drafting pen holder and container showing my new design, with the cover partially removed for clarity; FIG. 2 is a top plan view thereof; FIG. 3 is a right side elevational view thereof; FIG. 4 is a rear elevational view thereof; FIG. 5 is a bottom plan view thereof; FIG. 6 is a left side elevational view thereof; and FIG. 7 is a front elevational view thereof.

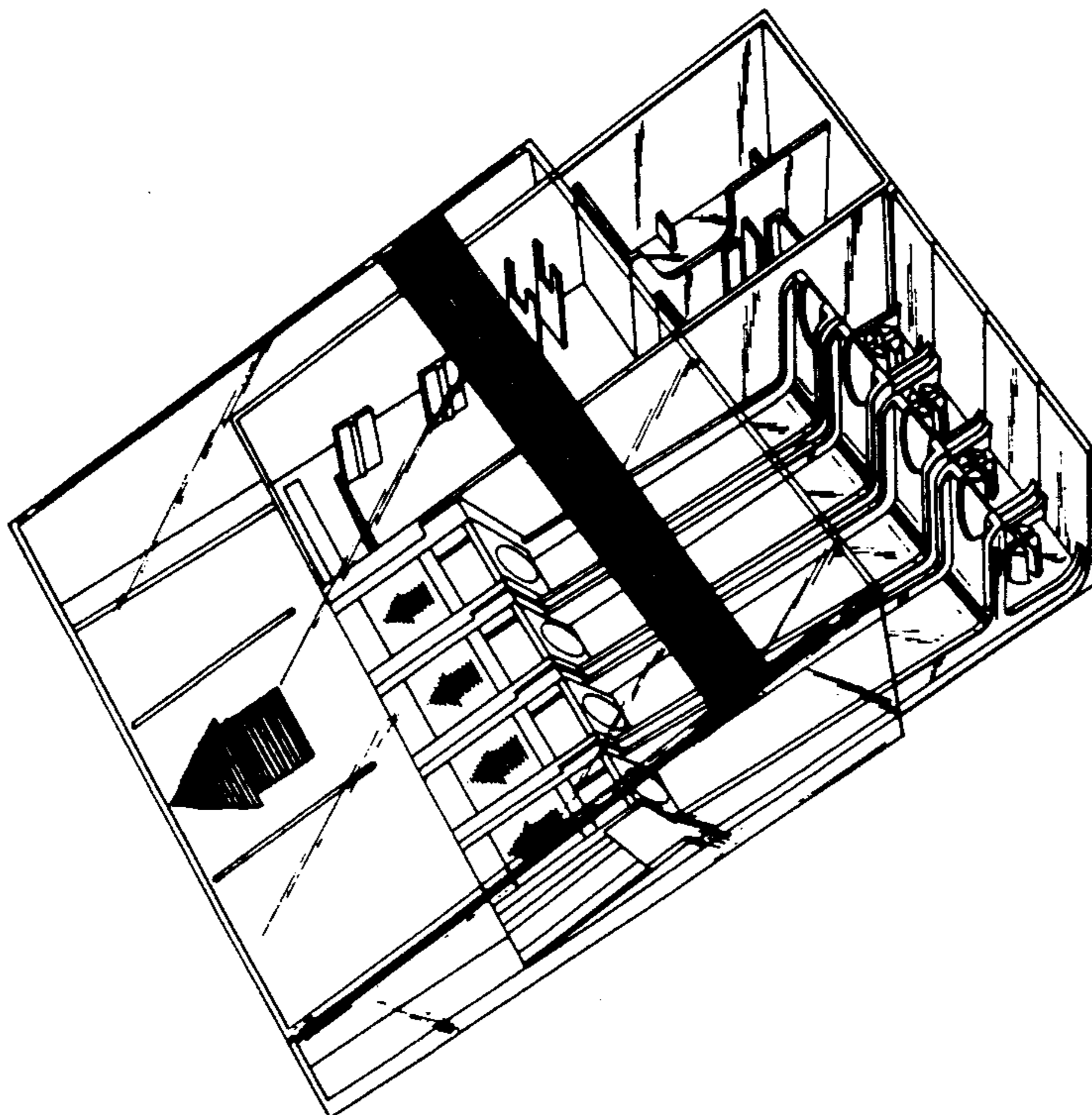
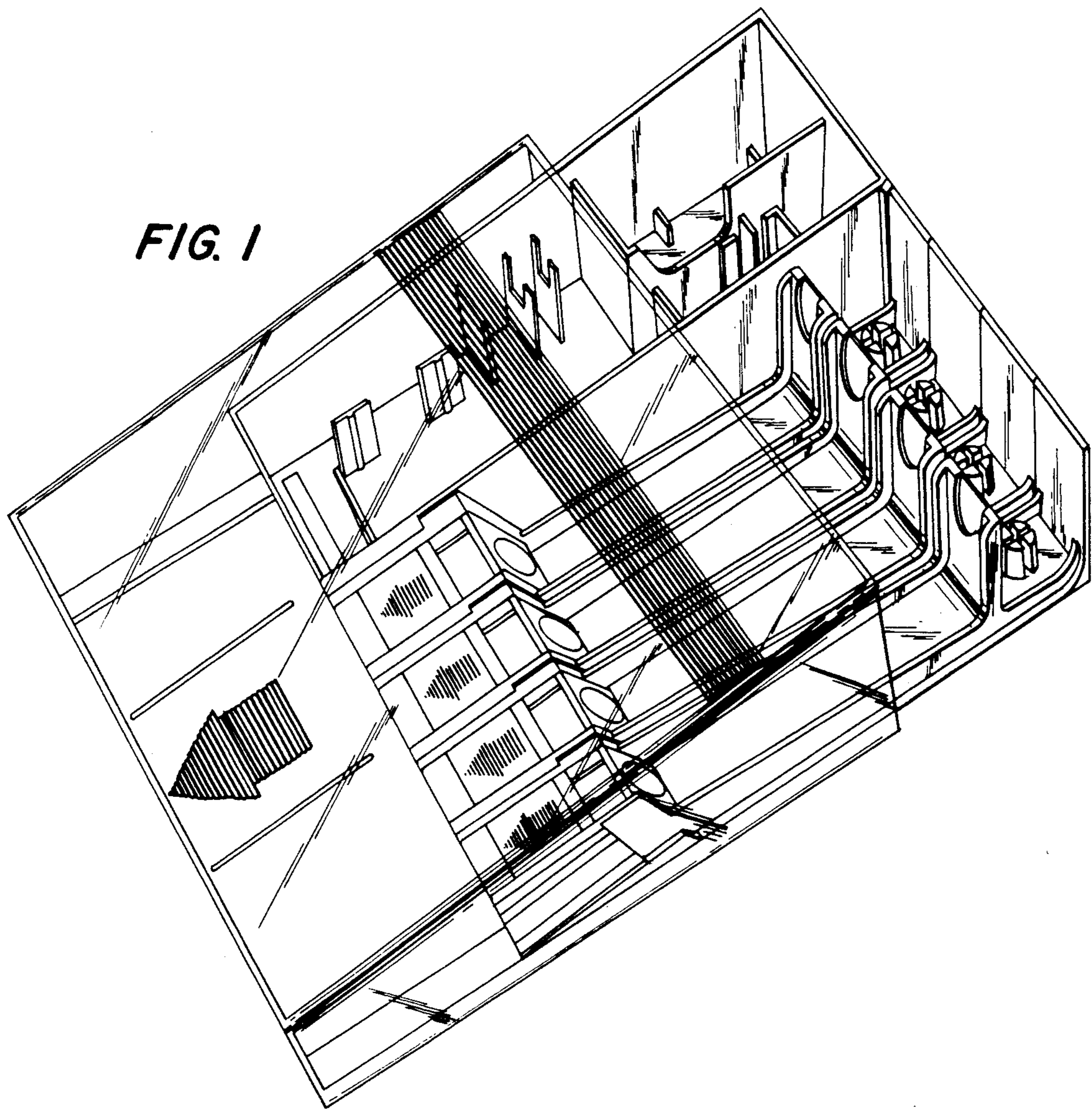

FIG. 1



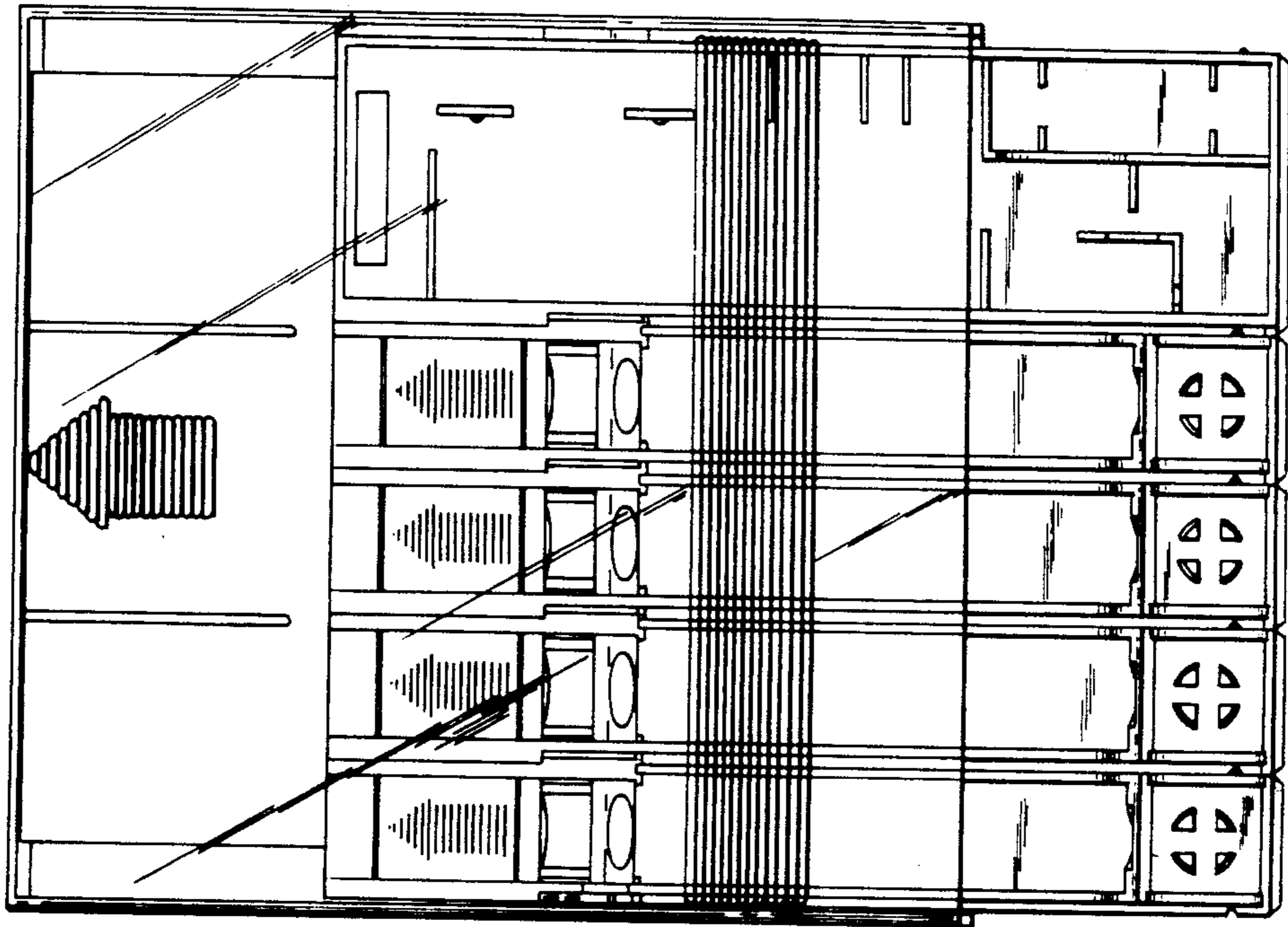

FIG. 2

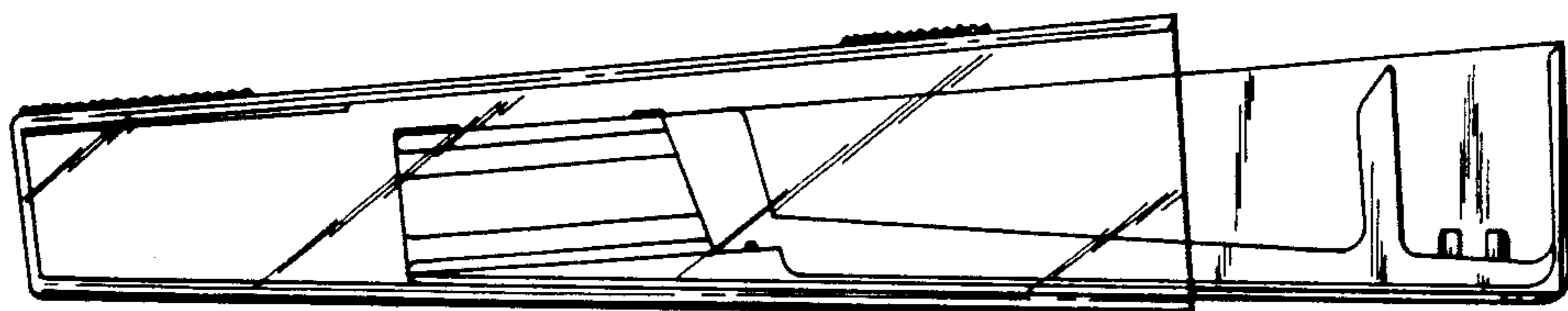

FIG. 3

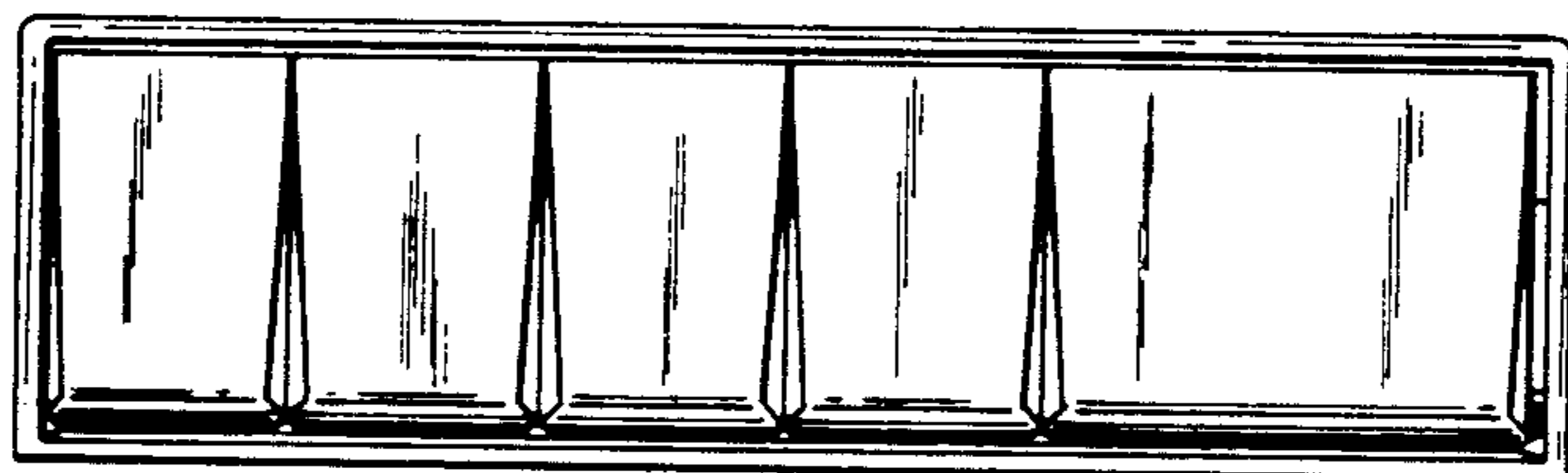

FIG. 4

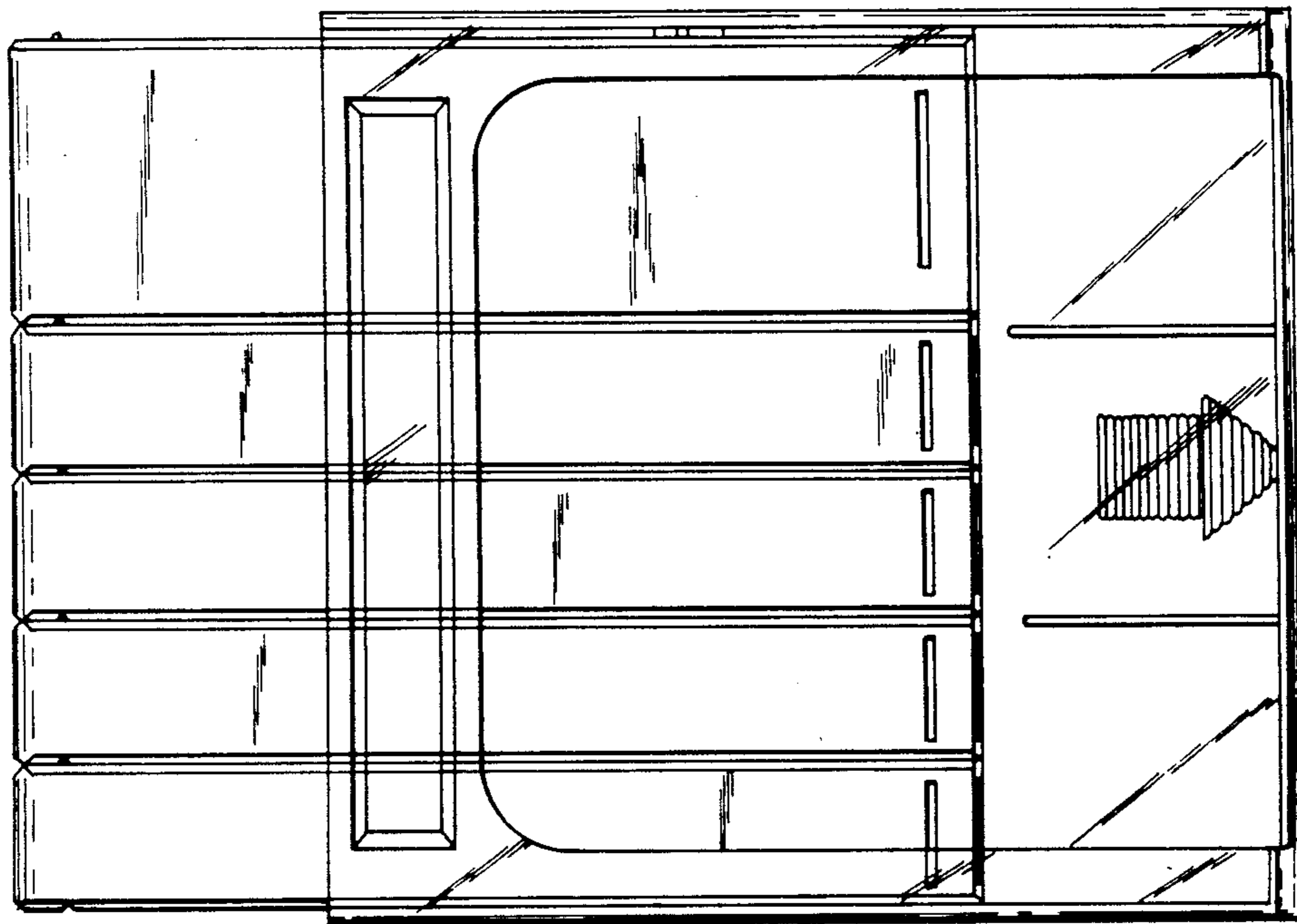

FIG. 5

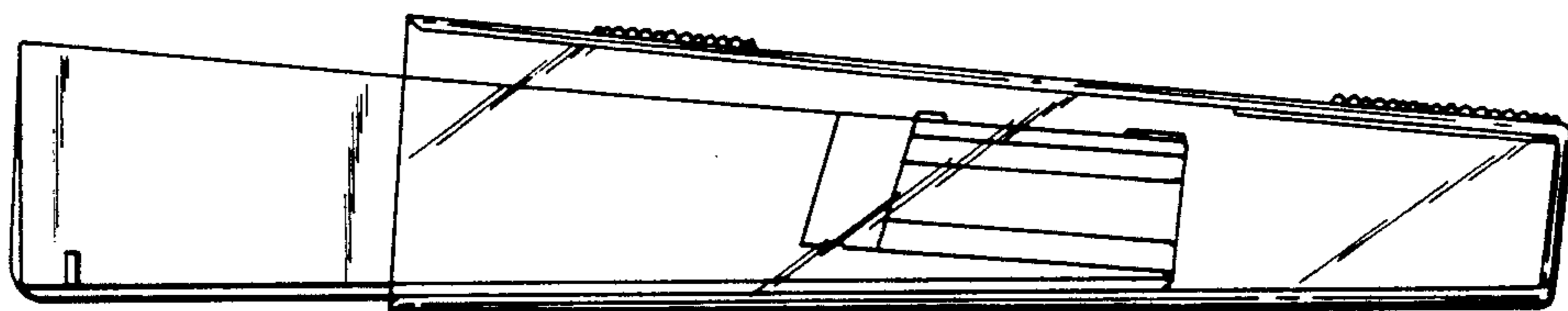

FIG. 6

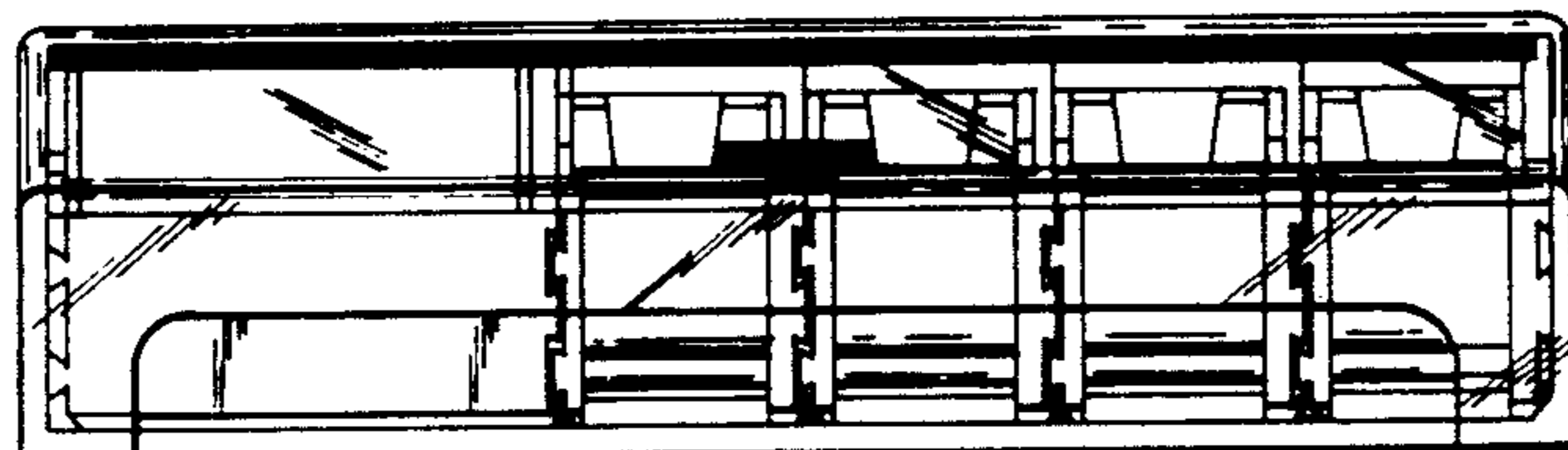

FIG. 7