

[54] **DENTAL CERAMIC STAIN TRAY**

[76] Inventor: **Donald Montez**, 2804 Eastridge Cir., Modesto, Calif. 95355

[**] Term: **14 Years**

[21] Appl. No.: **804,105**

[22] Filed: **Jun. 6, 1977**

[51] Int. Cl. **D24-02**

[52] U.S. Cl. **D24/10; D9/187; D24/31; D24/56**

[58] Field of Search 32/71, 39; D24/56, 10, D24/31, 99; D9/187, 188, 189, 184, 185; 206/561, 562

[56] **References Cited**

U.S. PATENT DOCUMENTS

D. 237,317 10/1975 Nowakowski et al. D9/185

D. 242,654 12/1976 Rawls D9/185

3,436,156 4/1969 Alder et al. 32/71 X

FOREIGN PATENT DOCUMENTS

518671 2/1931 Fed. Rep. of Germany 32/71

Primary Examiner—Bernard Ansher
Attorney, Agent, or Firm—Richard M. Worrel

[57] **CLAIM**

The ornamental design for a dental ceramic stain tray, as shown.

DESCRIPTION

FIG. 1 is a perspective view of the dental ceramic stain tray showing my new design;

FIG. 2 is a top plan view thereof;

FIG. 3 is a bottom plan view thereof;

FIG. 4 is a front elevation thereof;

FIG. 5 is a rear elevation thereof;

FIG. 6 is a side elevation thereof; and

FIG. 7 is a side elevation of the dental ceramic stain tray opposite to that shown in FIG. 6.

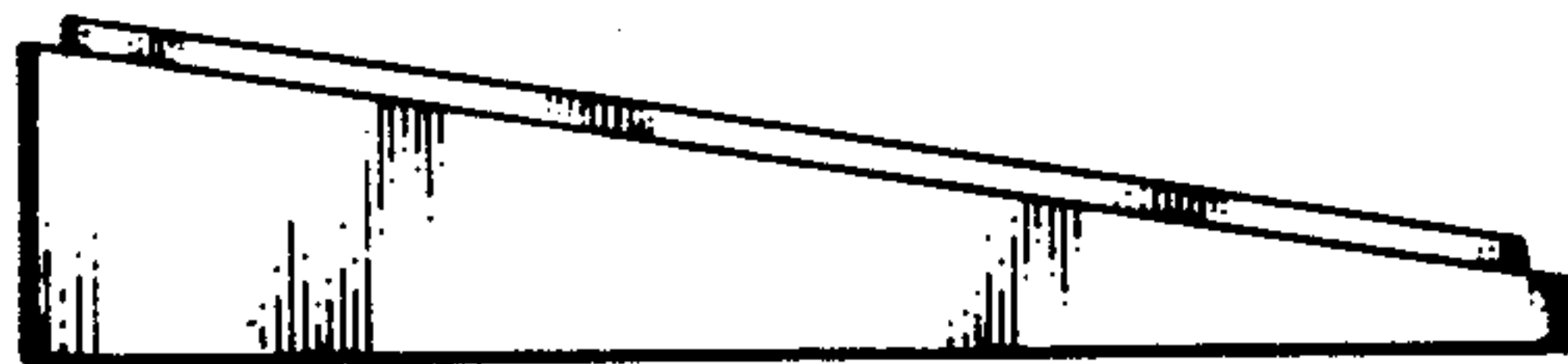
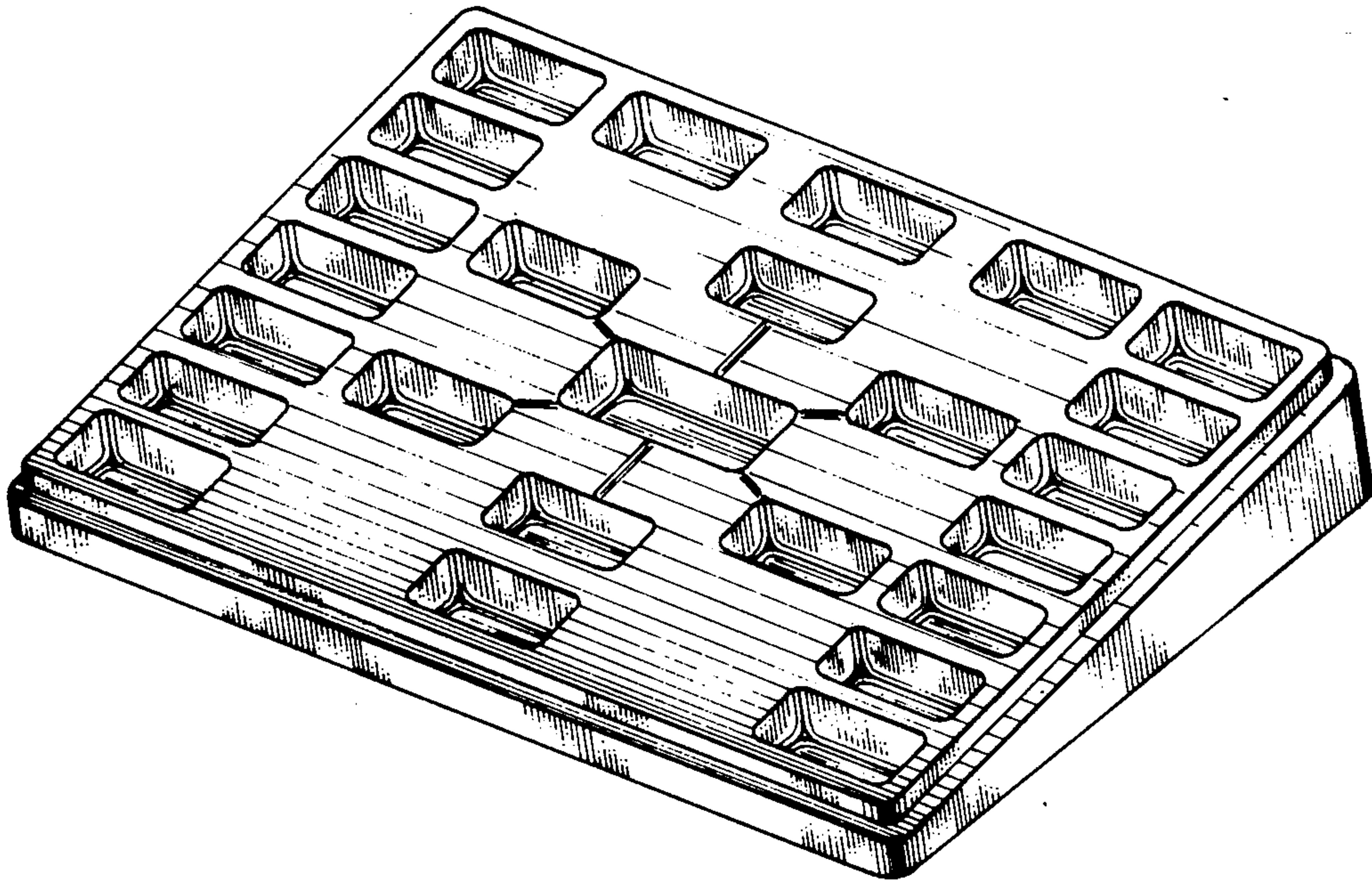

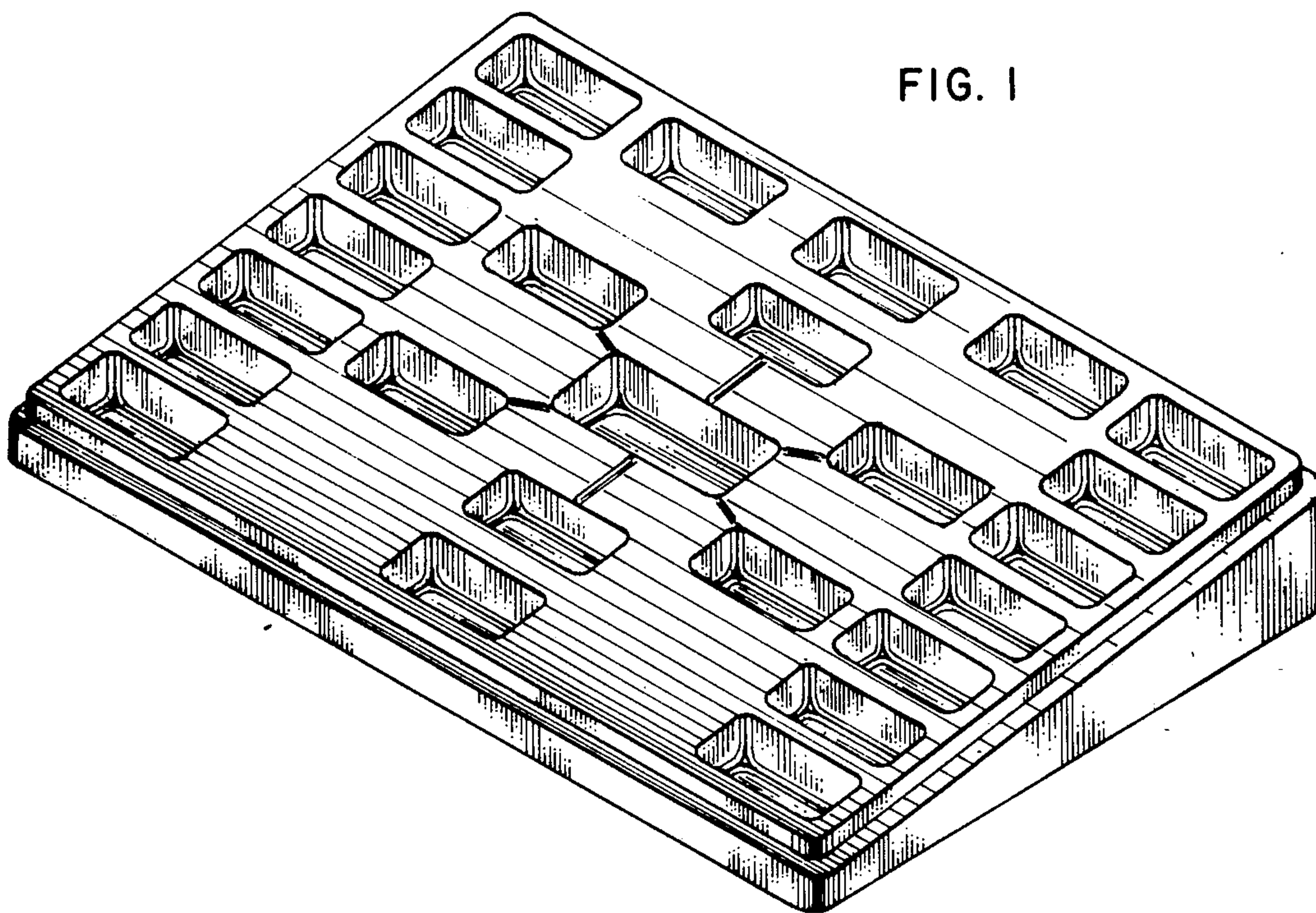

FIG. 2

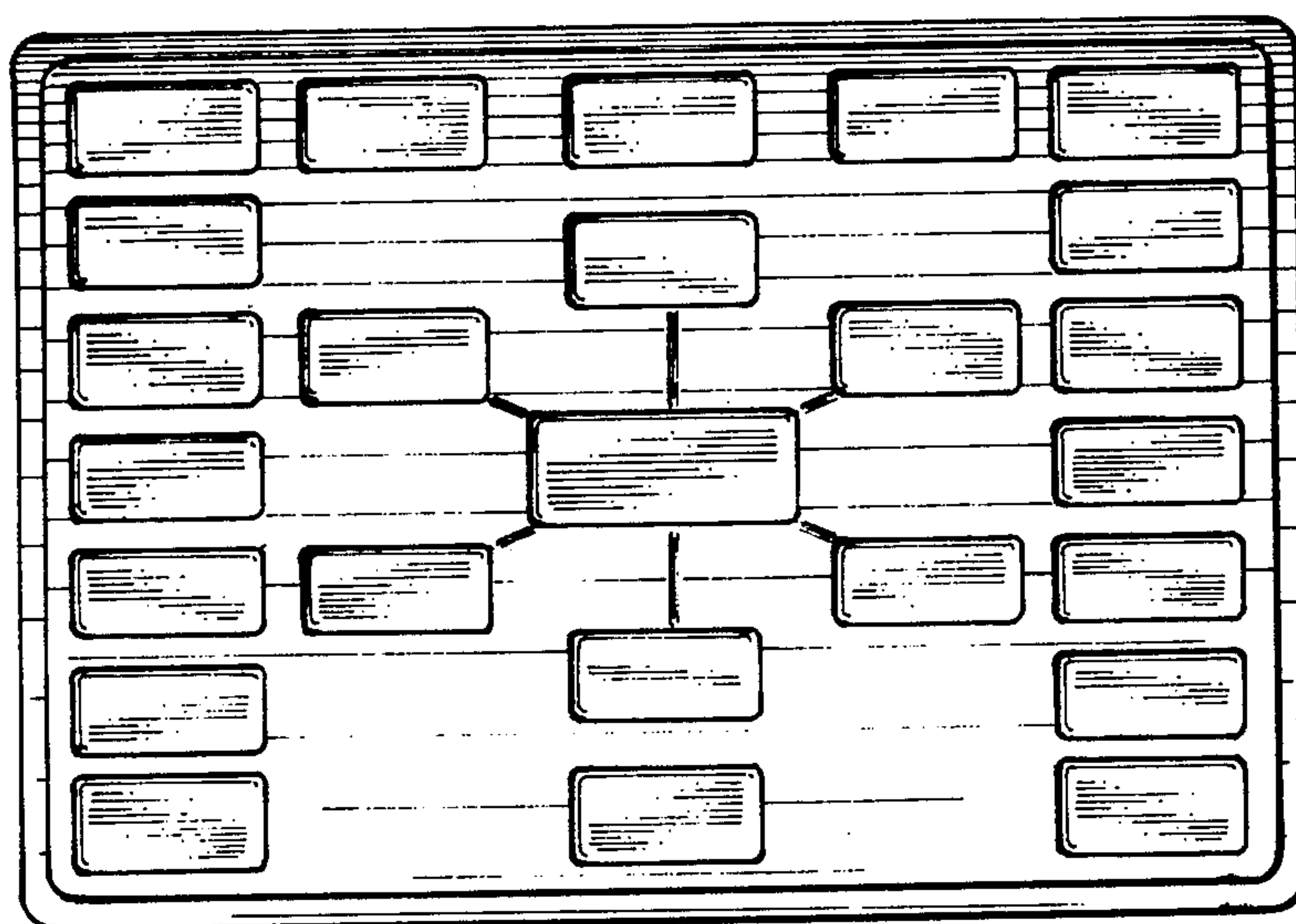

FIG. 3

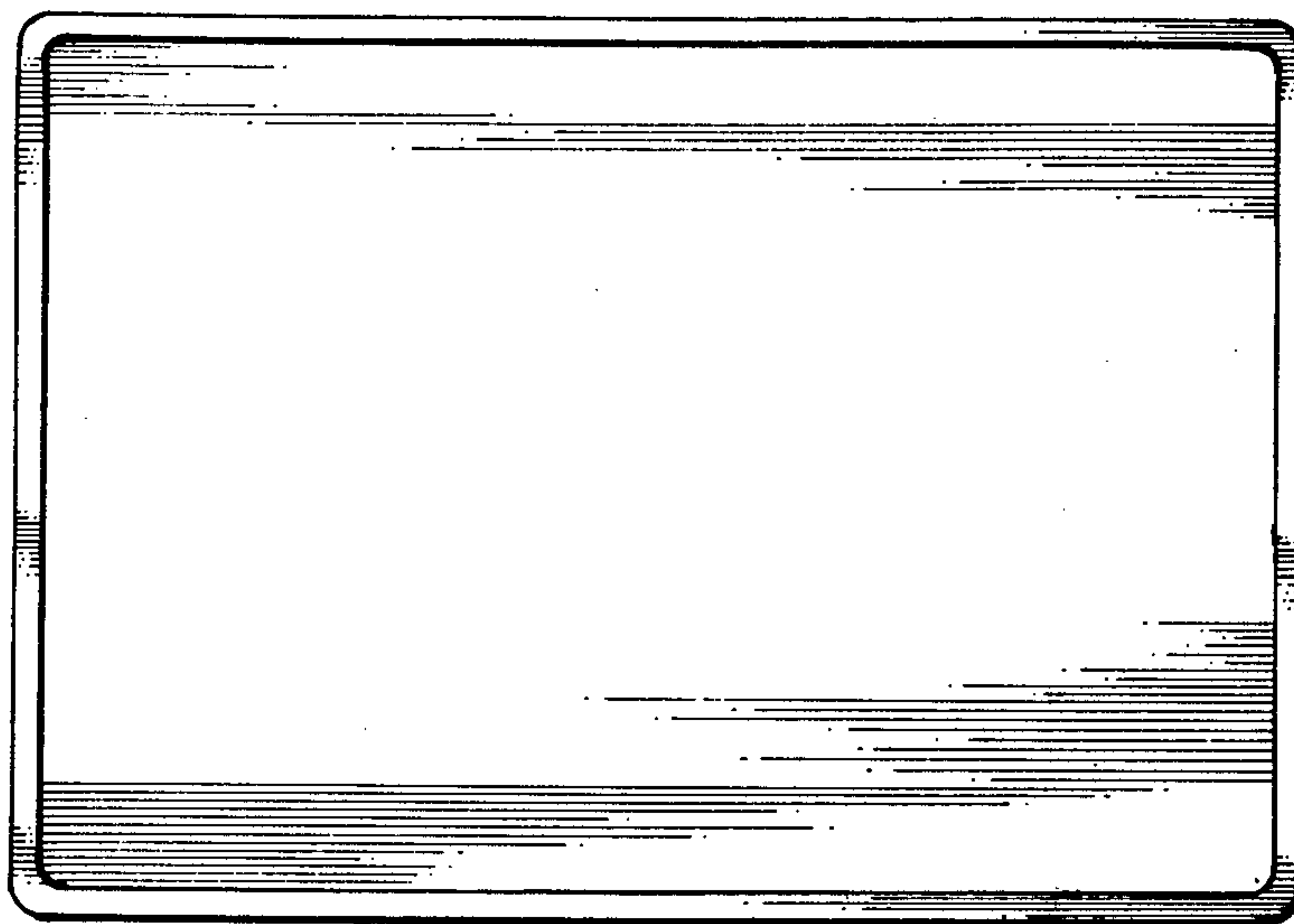

FIG. 4

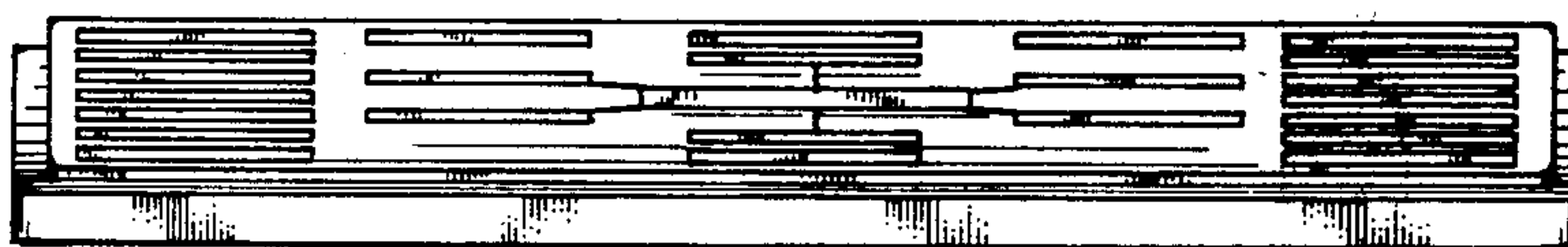

FIG. 5

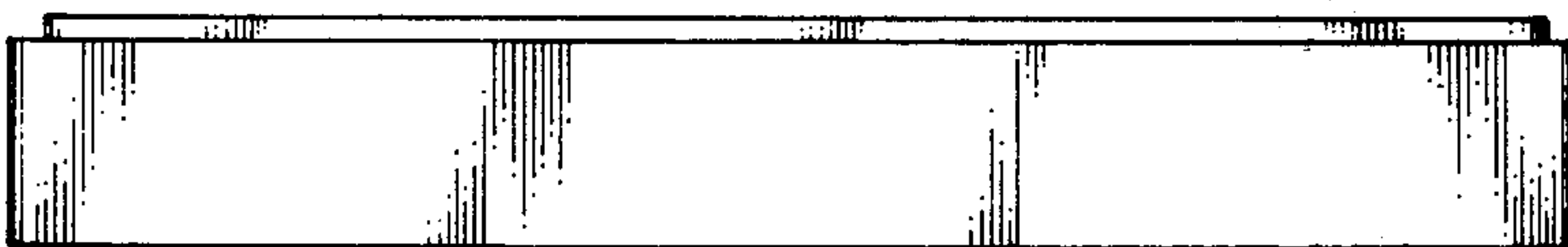

FIG. 6

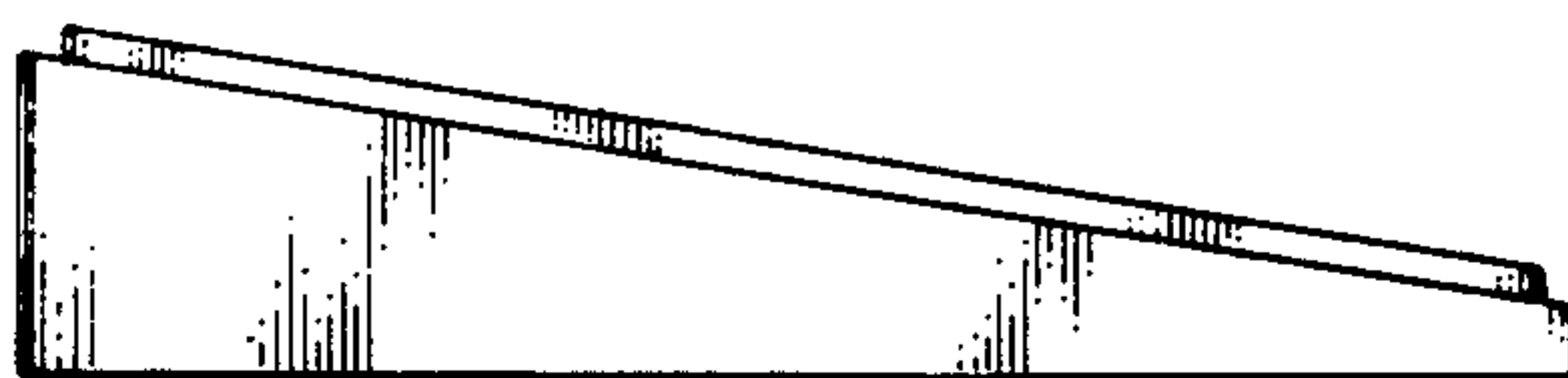

FIG. 7

