

[54] PUTTER HEAD

[76] Inventor: Richard C. Bennett, 7333 Armitage Ave., Elmwood Park, Ill. 60635

[\*\*] Term: 14 Years

[21] Appl. No.: 806,089

[22] Filed: Jun. 13, 1977

[51] Int. Cl. .... D21-02

[52] U.S. Cl. .... D21/217

[58] Field of Search ..... D34/5 GH, 5 GC; 273/167-175

[56] References Cited

PUBLICATIONS

Golf Digest, Jun. 1965, p. 6, left, Putter.

Wittek, Golf Range Supply Co., 1966, p. 28, bottom, item GM, Putter.

Primary Examiner—Melvin B. Feifer  
Attorney, Agent, or Firm—Edward U. Dithmar

[57] CLAIM

The ornamental design for a putter head, as shown.

DESCRIPTION

FIG. 1 is an elevational view of one side of a putter head incorporating the new design;

FIG. 2 is an elevational view of the opposite side of the putter;

FIG. 3 is a front elevational view of the putter head;

FIG. 4 is a rear elevational view of the putter head;

FIG. 5 is a bottom plan view of the putter head;

FIG. 6 is a view taken along the line 6-6 of FIG. 3; and

FIG. 7 is a view in section taken along the line 7-7 of FIG. 1.

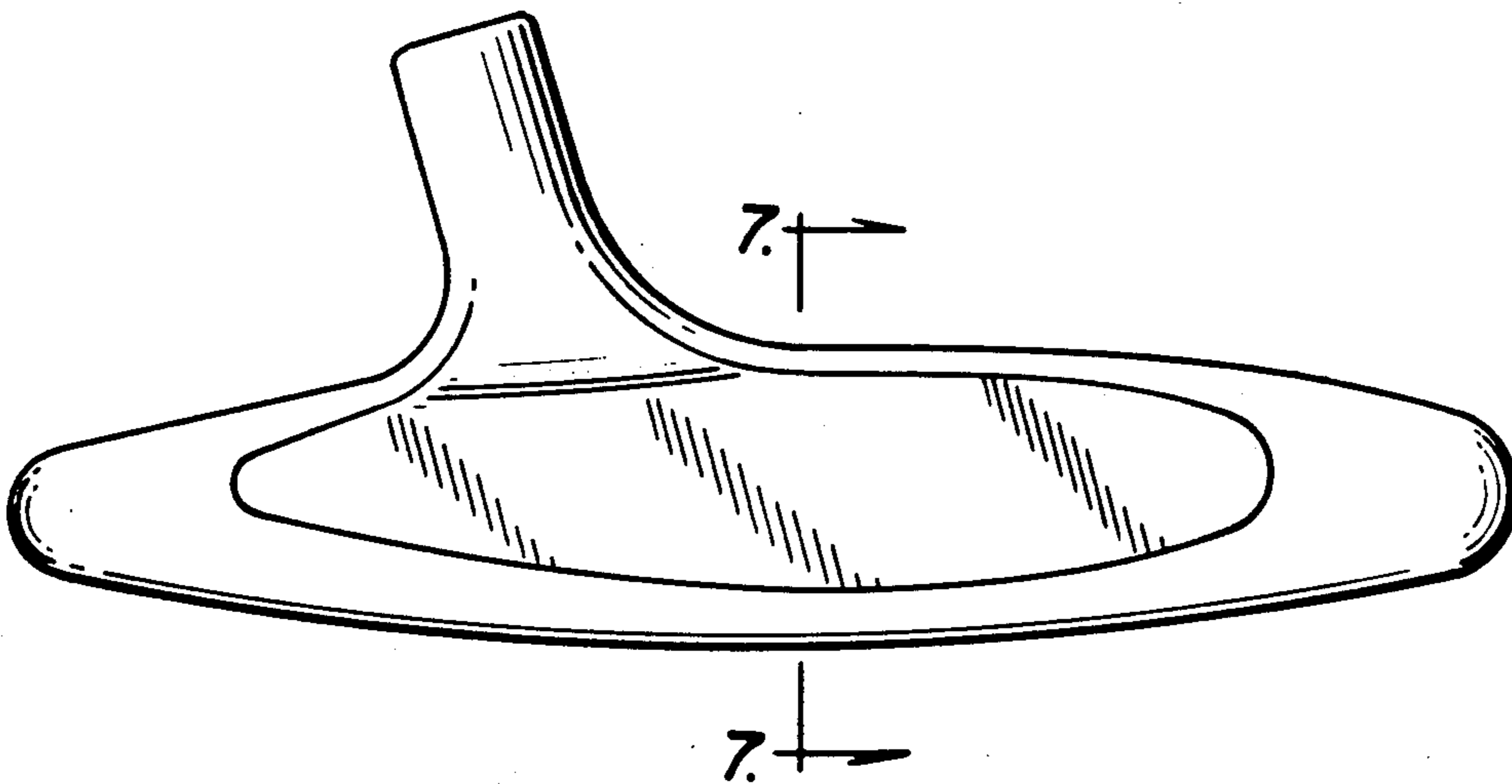

**FIG. 1**

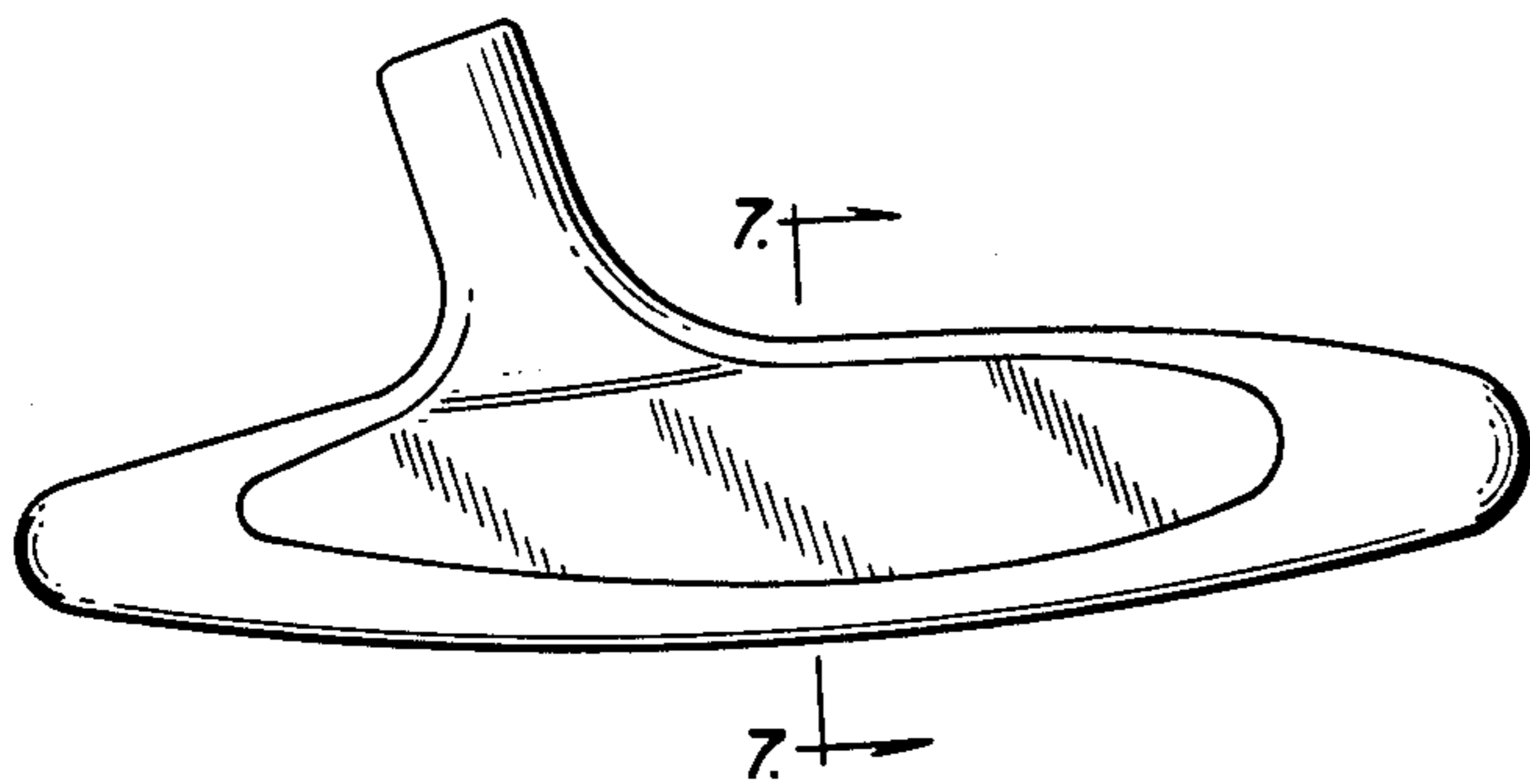

**FIG. 2**

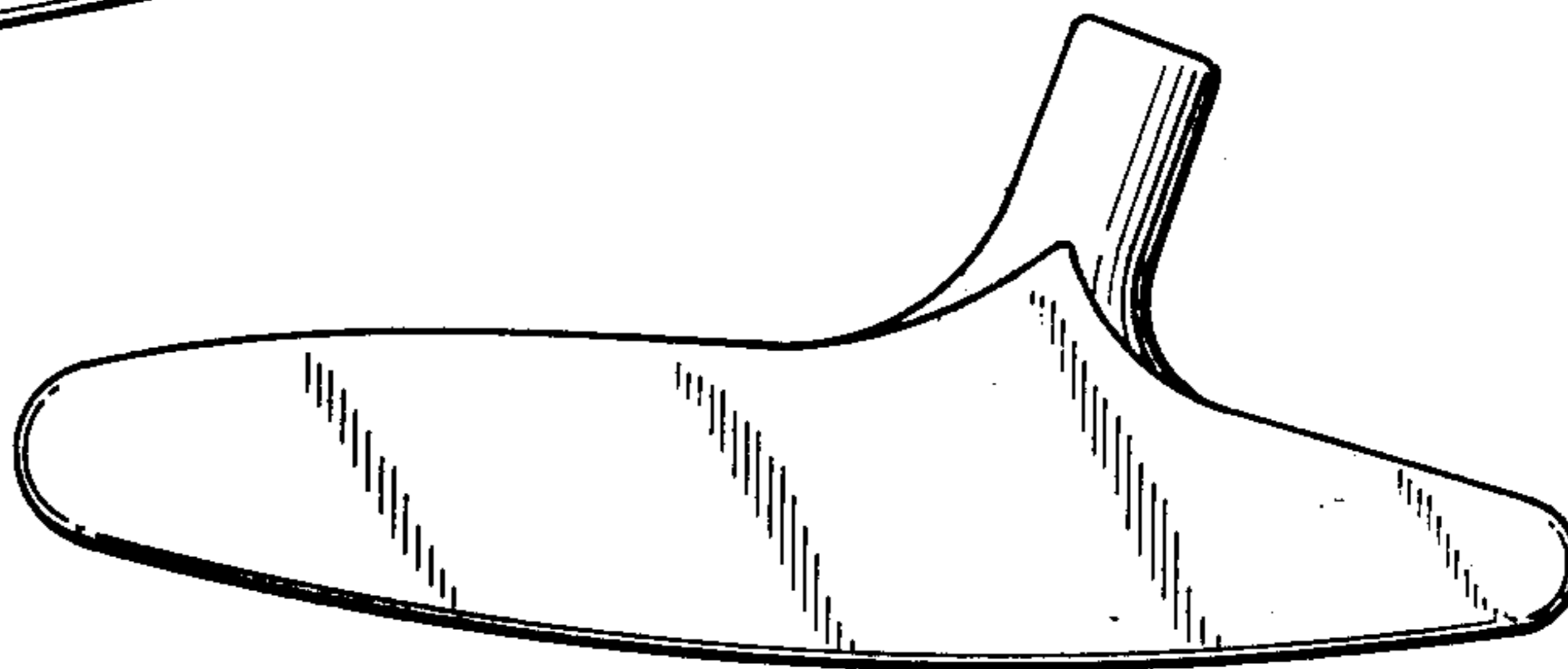

**FIG. 3**

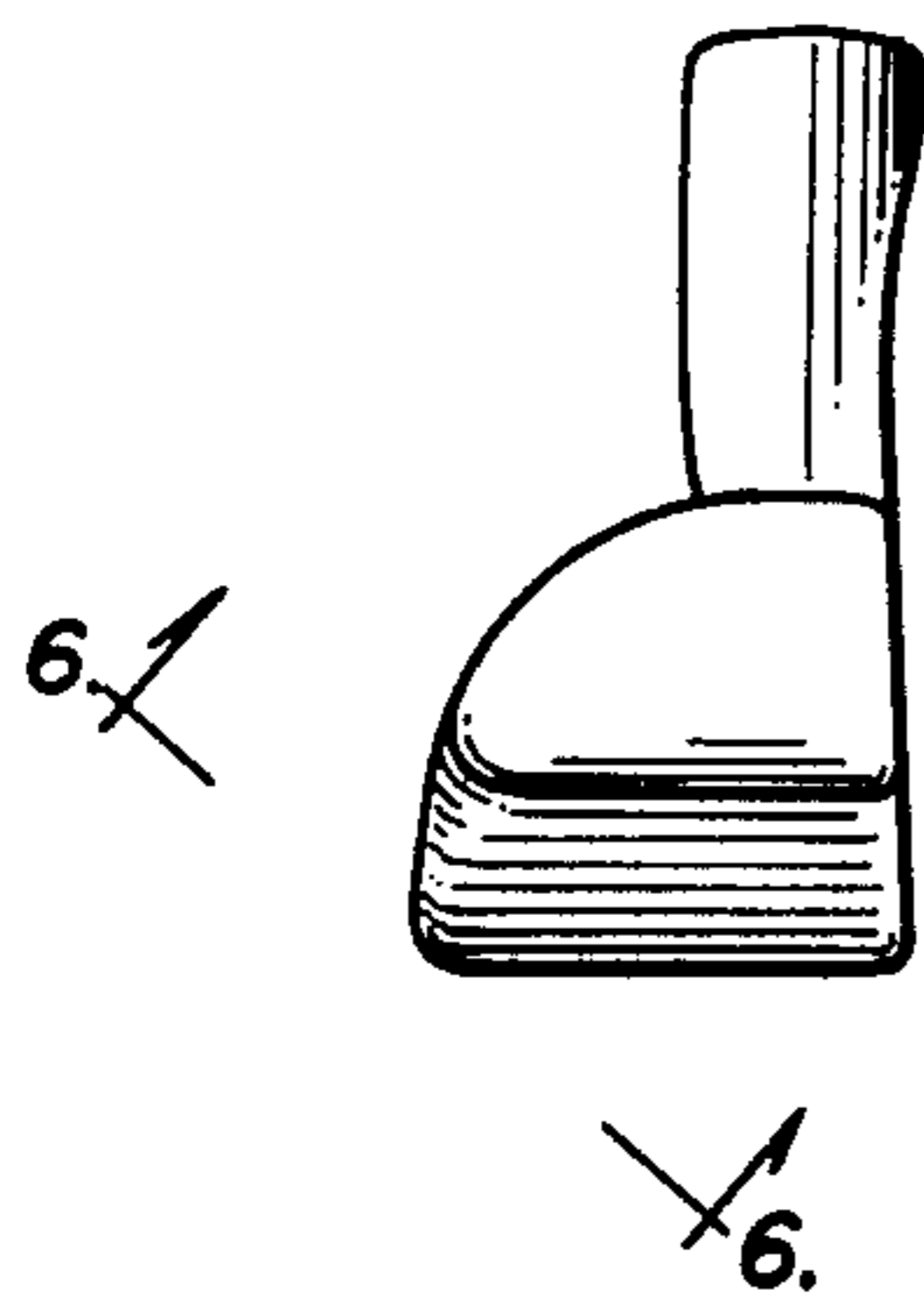

**FIG. 5**

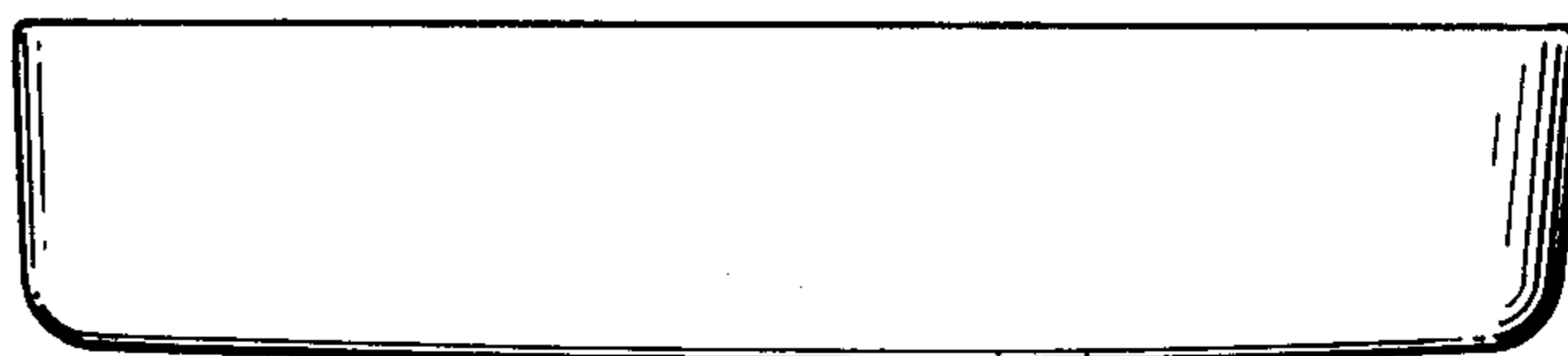

**FIG. 4**

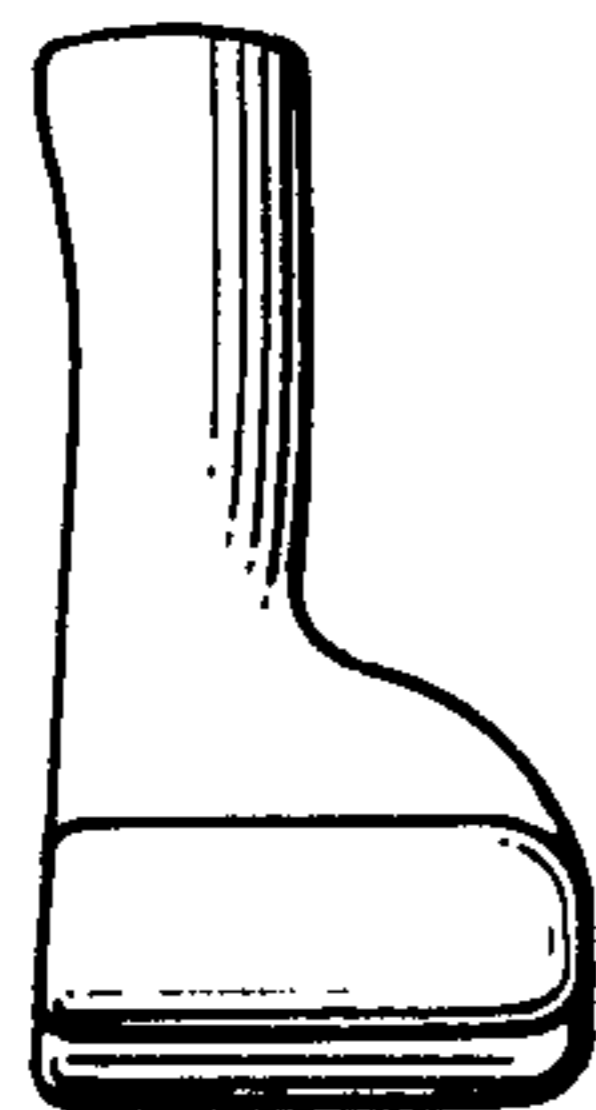

**FIG. 7**

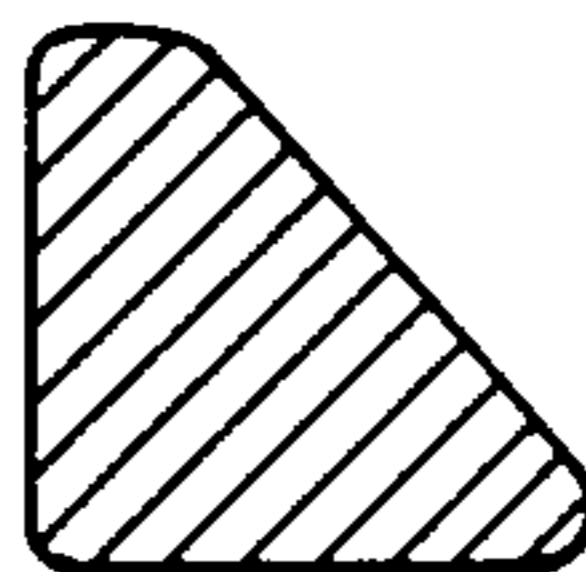

**FIG. 6**

