

[54] FIREPLACE GRATE

[76] Inventor: David N. Whitaker, 3013 Western Dr., Garland, Tex. 75042

[\*\*] Term: 3½ Years

[21] Appl. No.: 849,489

[22] Filed: Nov. 7, 1977

[51] Int. Cl. .... D7-08

[52] U.S. Cl. .... D7/207

[58] Field of Search ..... D7/206, 207; D23/93, D23/94, 95, 96, 97; 126/120, 121, 135, 136, 152 R, 163 R, 163 A, 164, 165

[56] References Cited

U.S. PATENT DOCUMENTS

D. 188,743 8/1960 Arrano ..... D7/207  
D. 195,494 6/1963 Albert ..... D7/207

Primary Examiner—Wallace R. Burke  
Assistant Examiner—Catherine Kemper  
Attorney, Agent, or Firm—E. Mickey Hubbard

[57] CLAIM

The ornamental design for a fireplace grate, as shown and described.

DESCRIPTION

FIG. 1 is a front view of a fireplace grate showing my new design;  
FIG. 2 is a back view thereof;  
FIG. 3 is a top plan view thereof;  
FIG. 4 is a bottom view thereof;  
FIG. 5 is a side elevation view thereof; and  
FIG. 6 is a perspective view thereof.

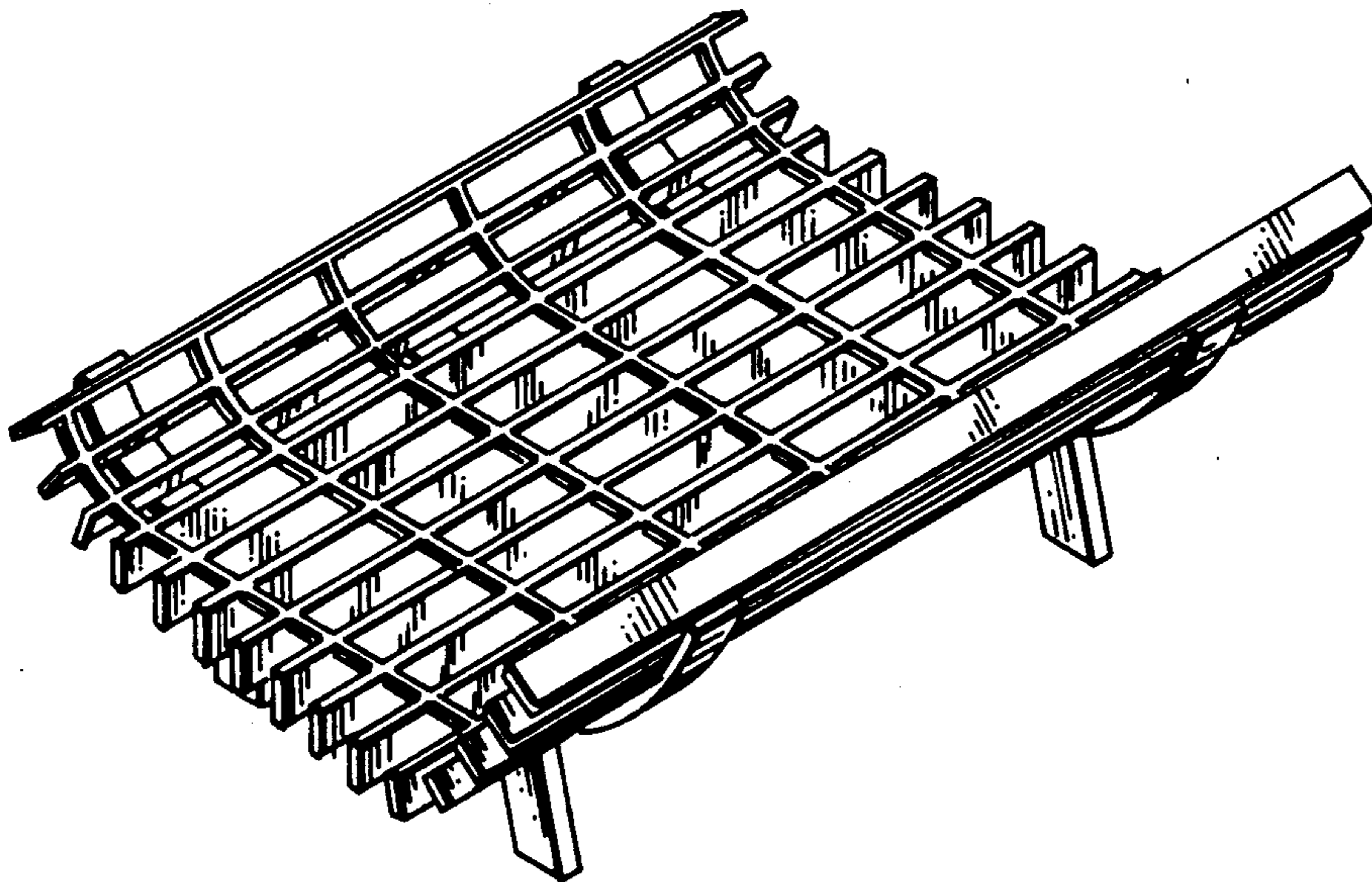

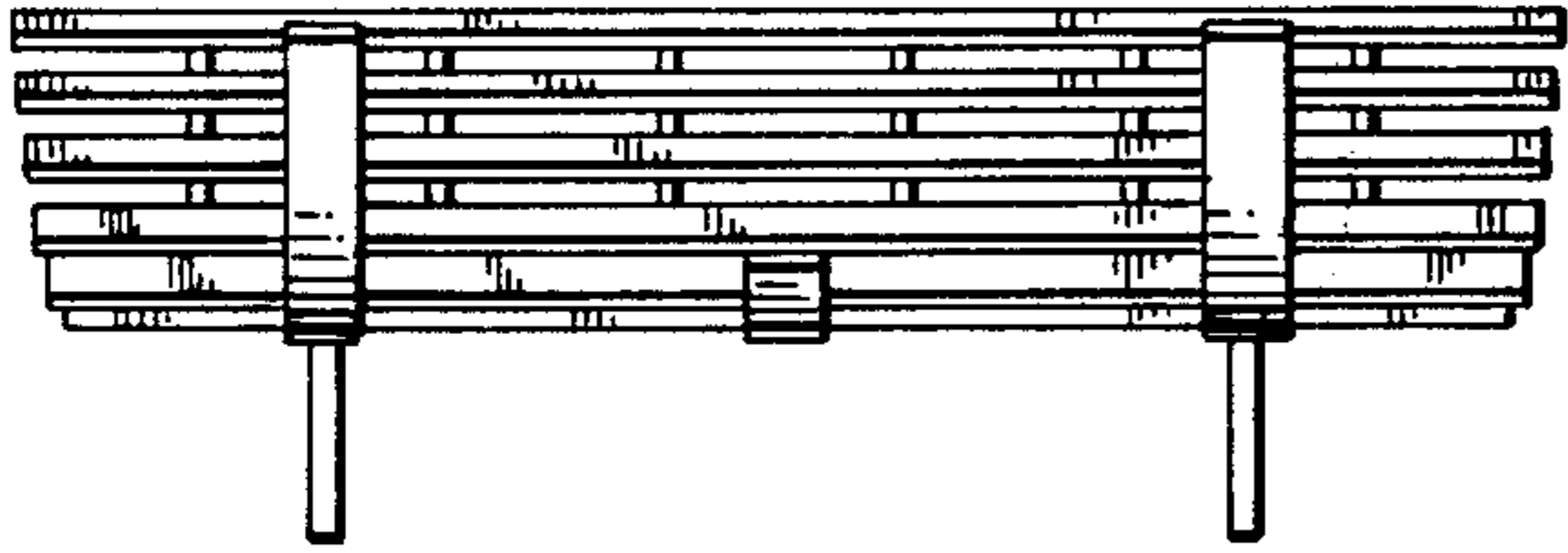

FIG. 1

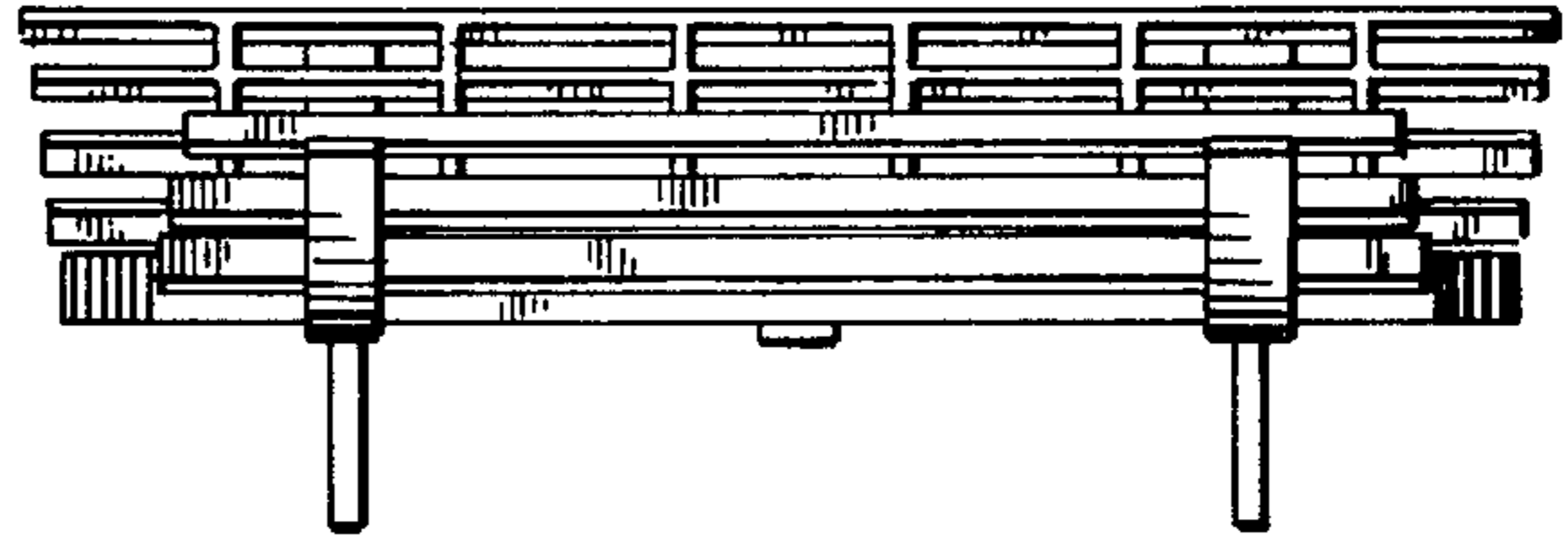

FIG. 2

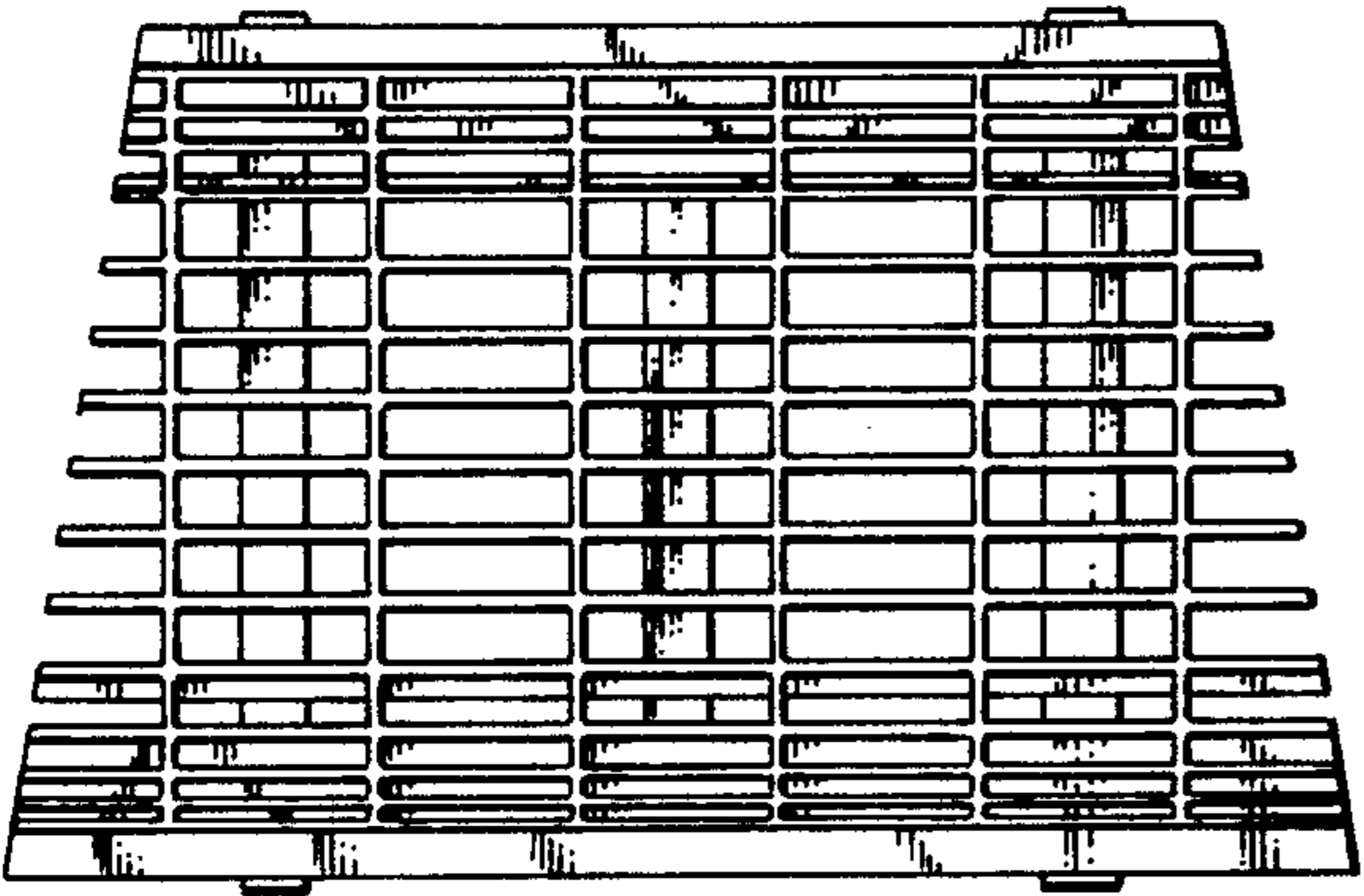

FIG. 3

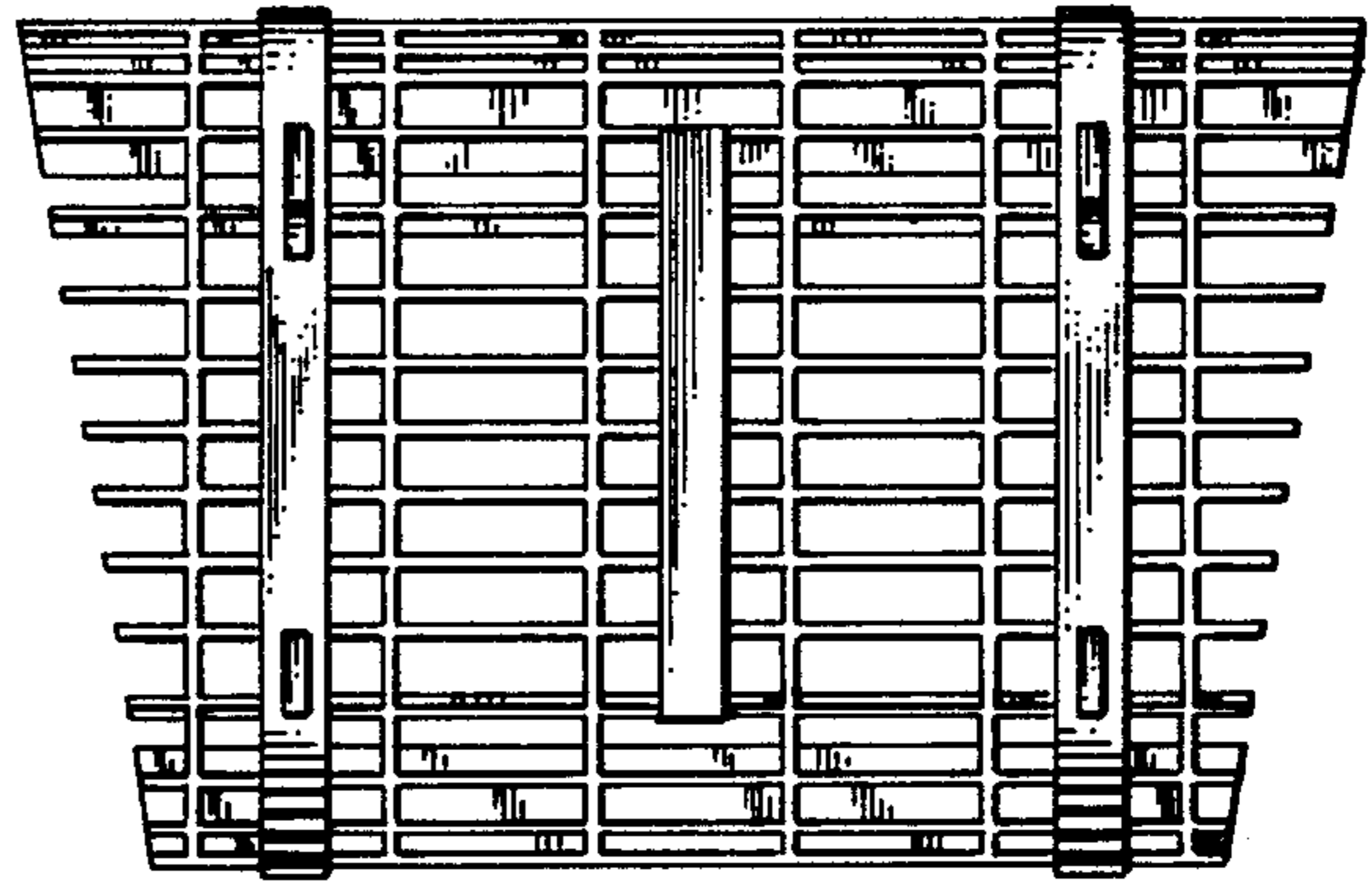

FIG. 4

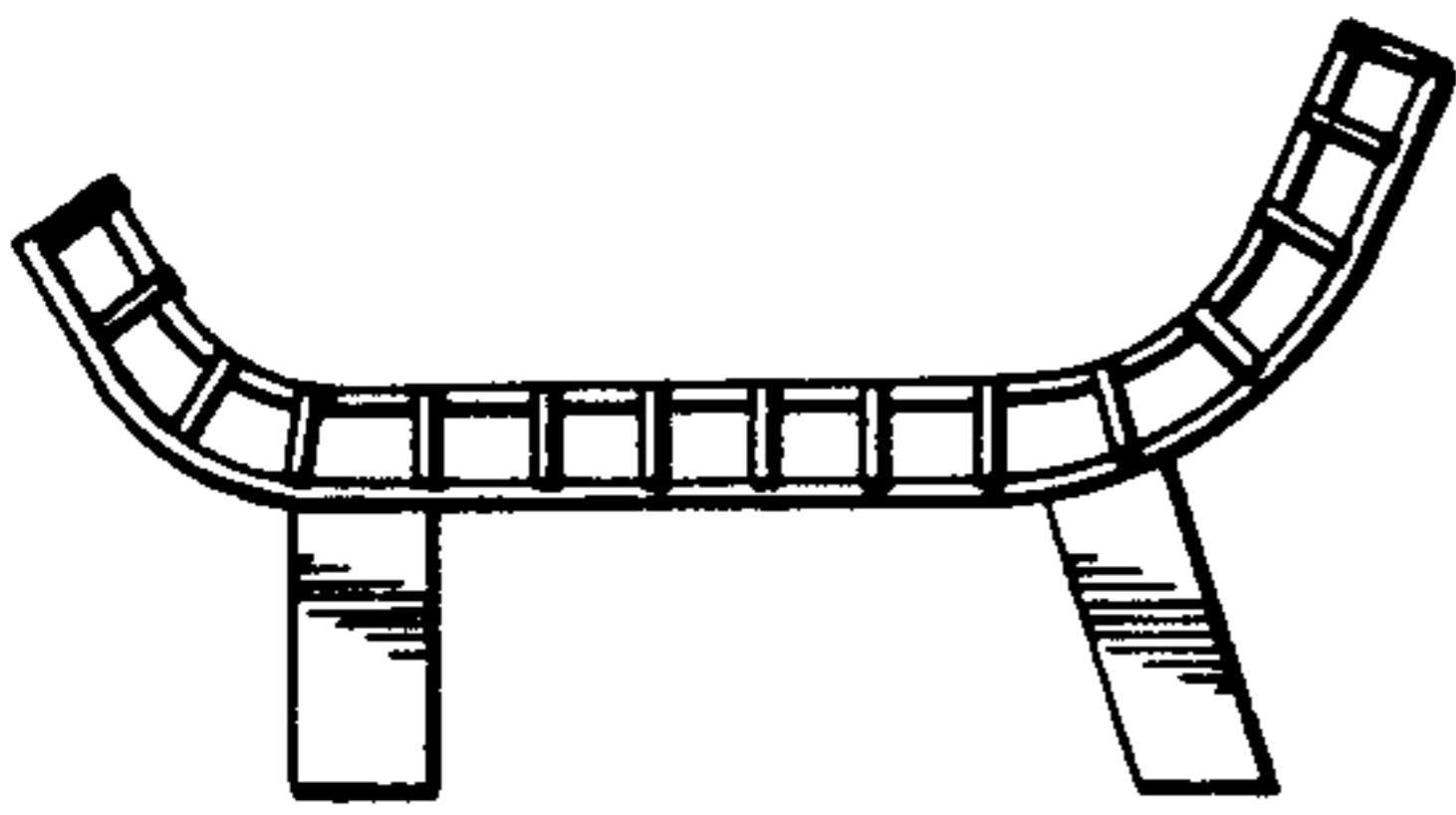

FIG. 5

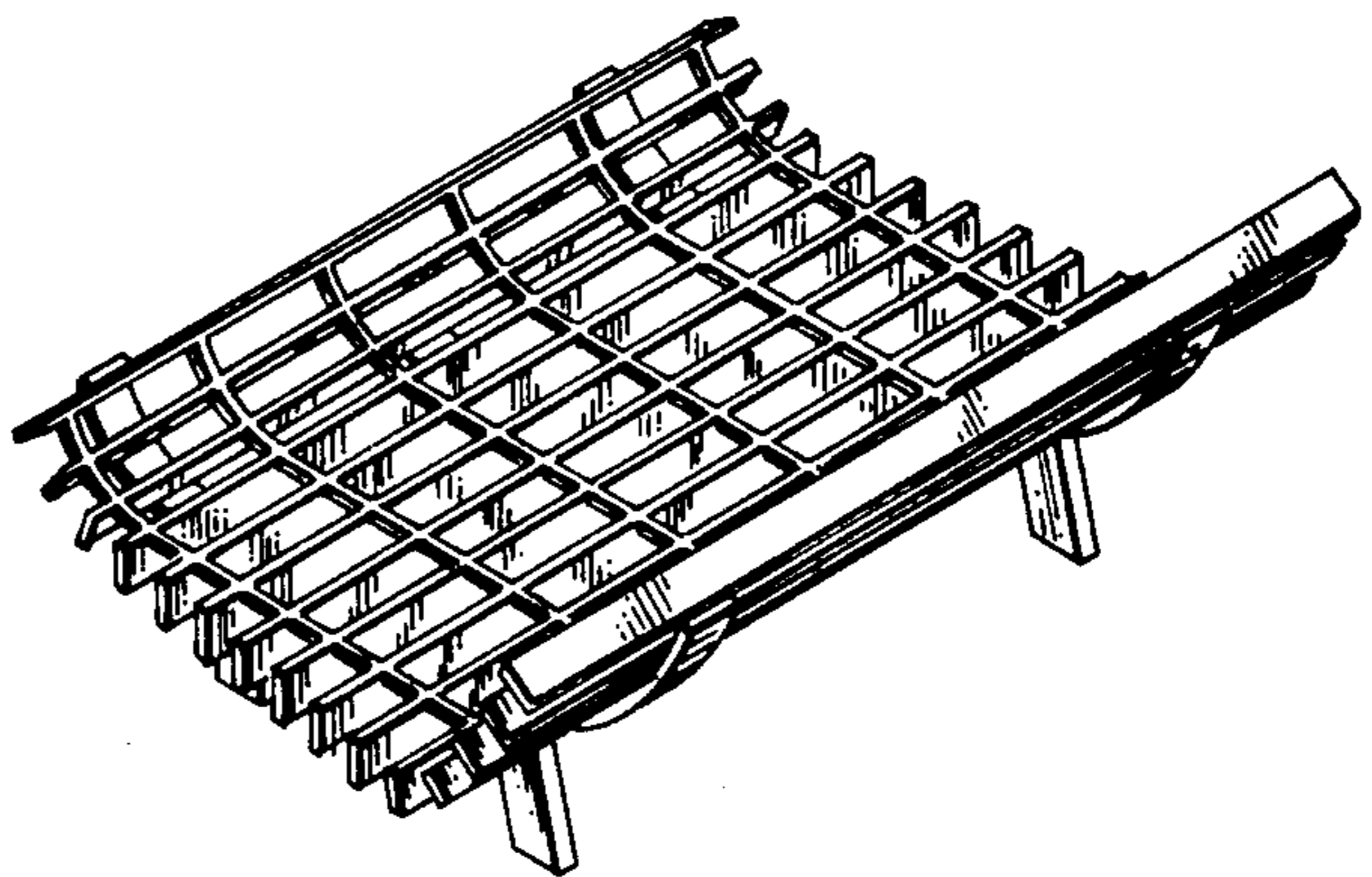

FIG. 6