

[54] TENNIS BALL CARRIER

[76] Inventor: Spencer H. Robley, 1034 Pine St., Santa Monica, Calif. 90405

[\*\*] Term: 14 Years

[21] Appl. No.: 869,386

[22] Filed: Jan. 13, 1978

[51] Int. Cl. .... D02-07

[52] U.S. Cl. .... D2/400; D2/381

[58] Field of Search ..... D2/381, 400; D34/5 ST; 224/5 R, 5 A, 5 D, 5 E, 26 B, 26 D

[56] References Cited

U.S. PATENT DOCUMENTS

1,814,887	7/1931	Bender	.....	224/5 D
2,708,061	5/1955	Kotchka	.....	224/5 D
3,768,709	10/1973	Kinard	.....	224/5 D

Primary Examiner—Joel Stearman

Assistant Examiner—Carmen H. Vales  
Attorney, Agent, or Firm—Thomas P. Mahoney

[57] CLAIM

The ornamental design for a tennis ball carrier, as shown and described.

DESCRIPTION

FIG. 1 is a front elevational view of a tennis ball carrier showing my new design;

FIG. 2 is a top plan view thereof;

FIG. 3 is a rear elevational view thereof;

FIG. 4 is a side elevational view thereof;

FIG. 5 is a sectional view taken along line 5-5 of FIG. 3.

FIG. 6 is a front elevational view of a modified form of a tennis ball carrier showing my design wherein the belt portion passes through the base portion of the U-shaped ball holding members; and

FIG. 7 is a sectional view taken along line 7-7 of FIG. 6.

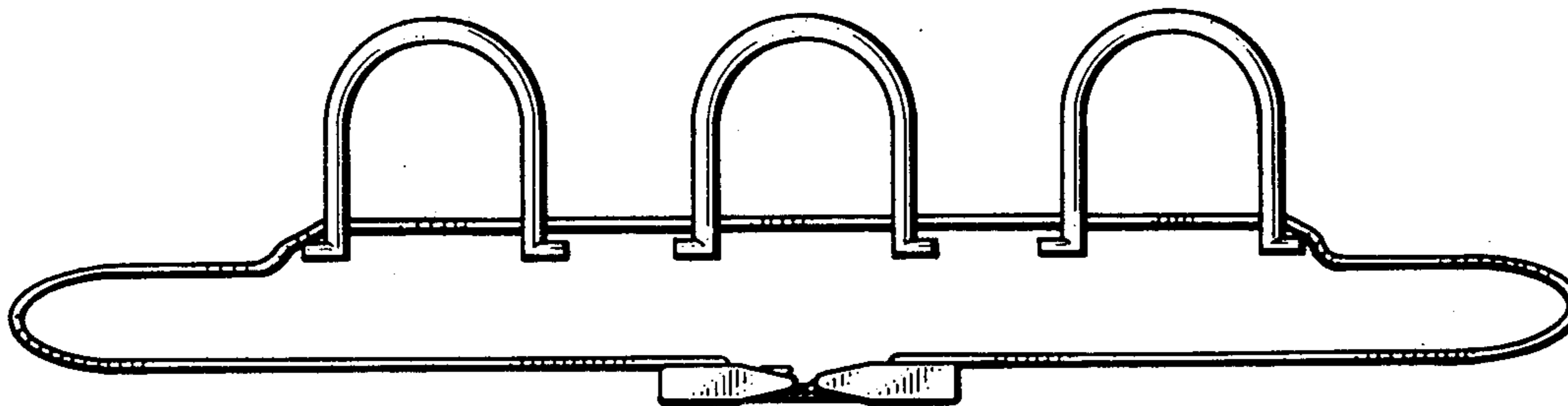
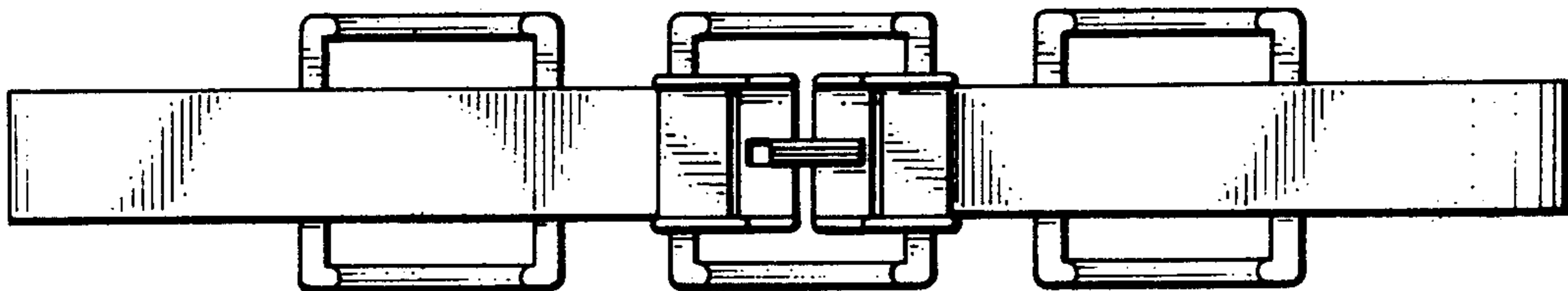

Fig. 1.

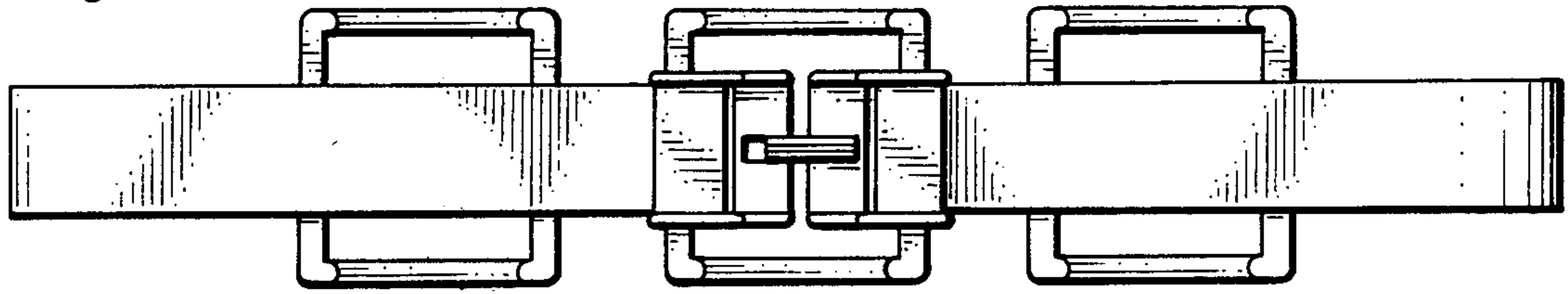

Fig. 2.

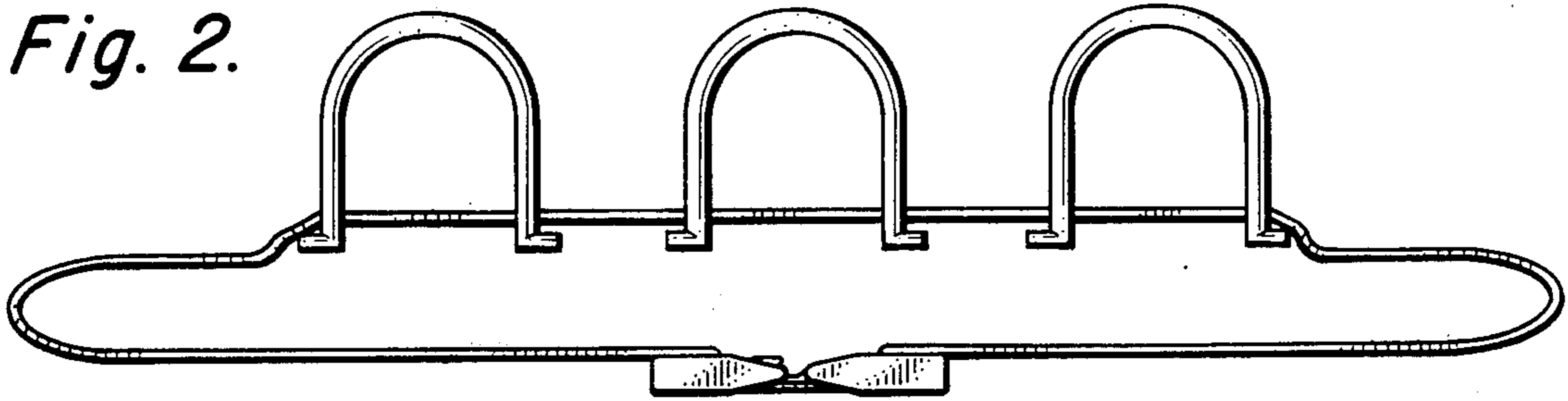

Fig. 3.

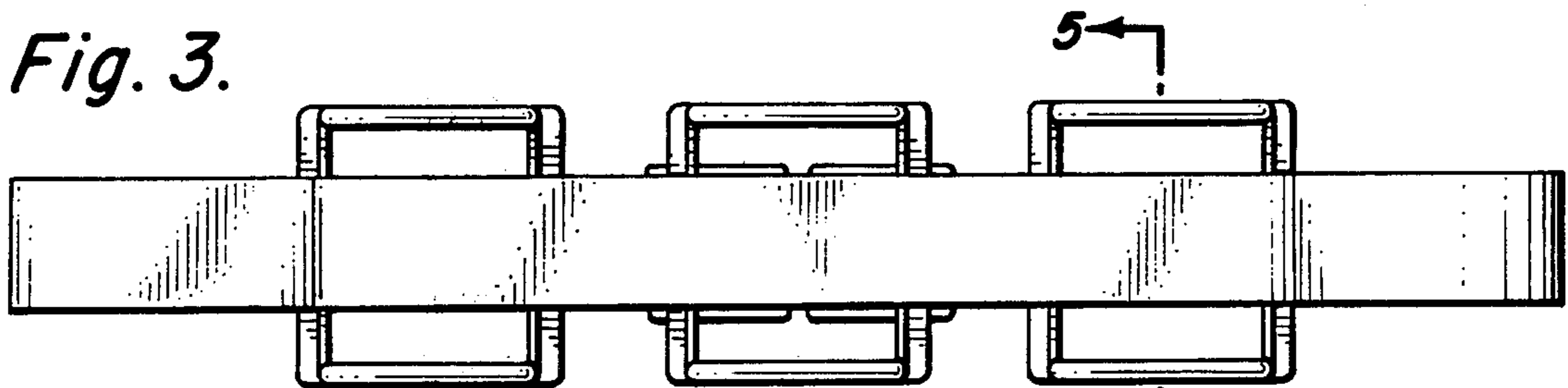

Fig. 4.

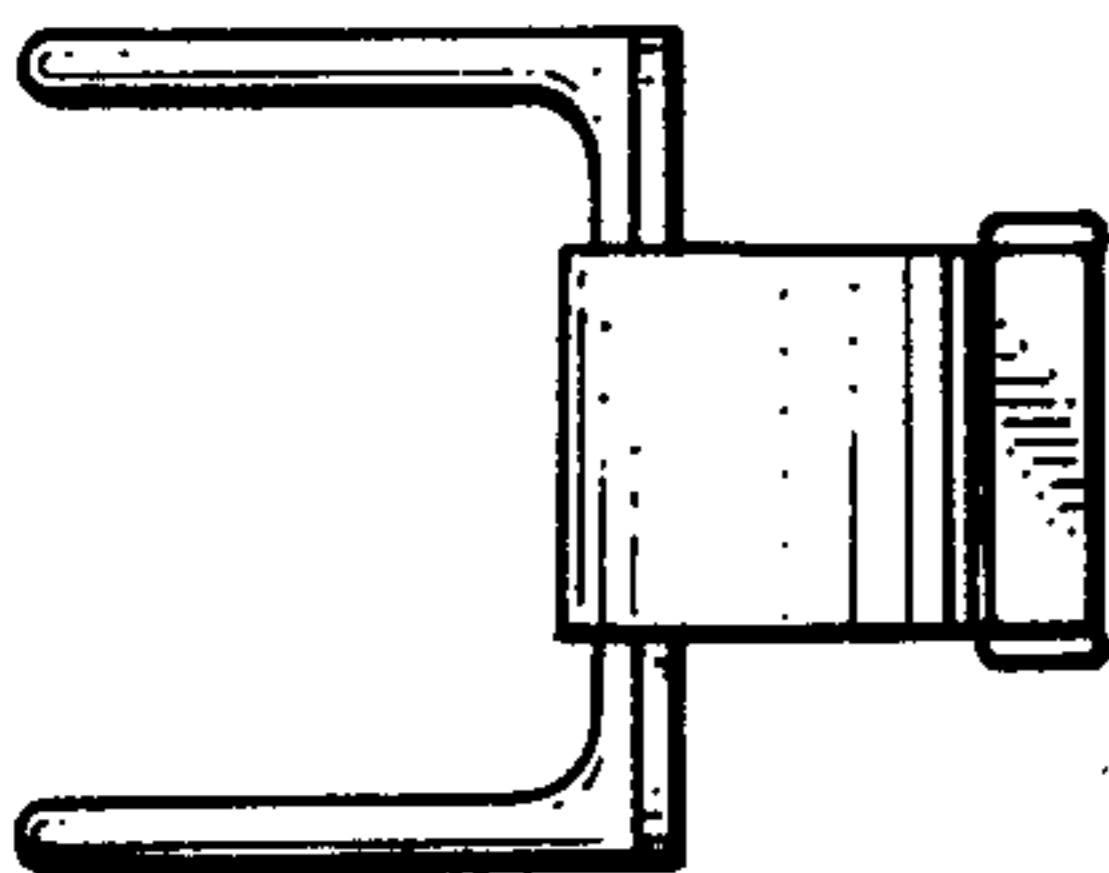

Fig. 5.

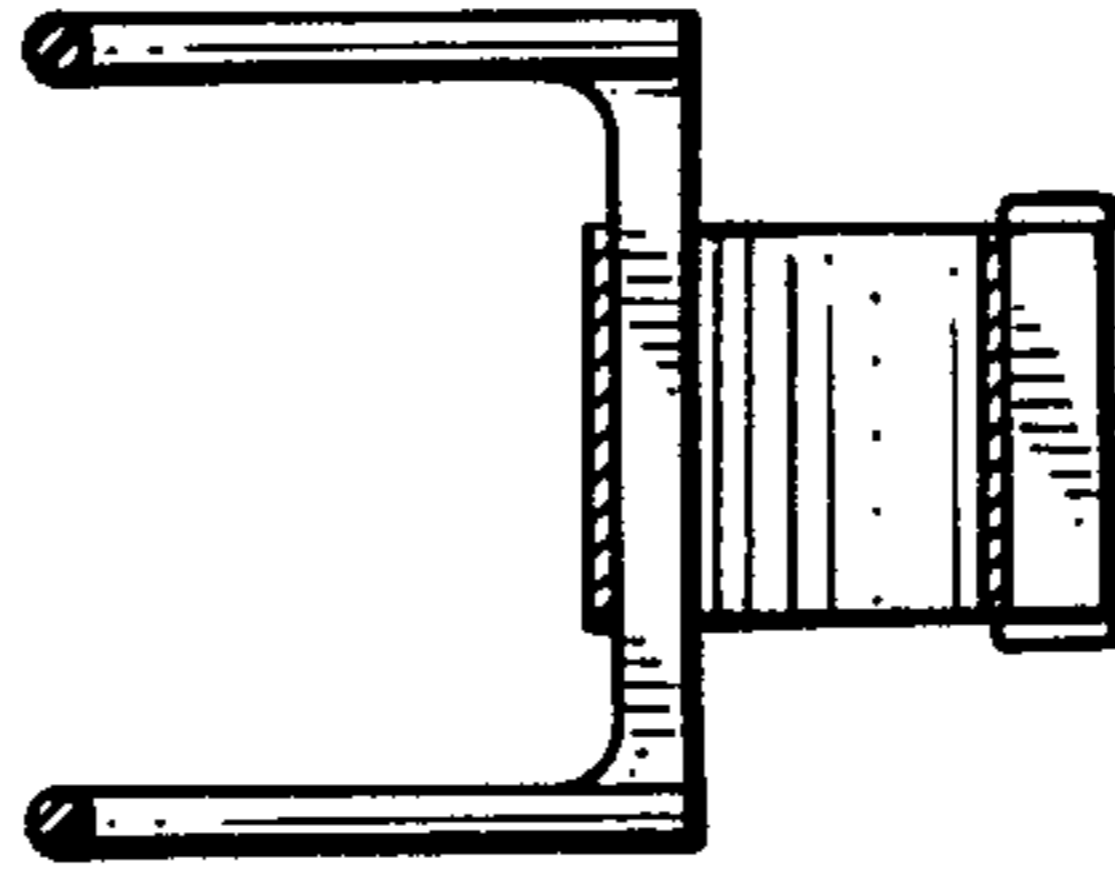

Fig. 7.

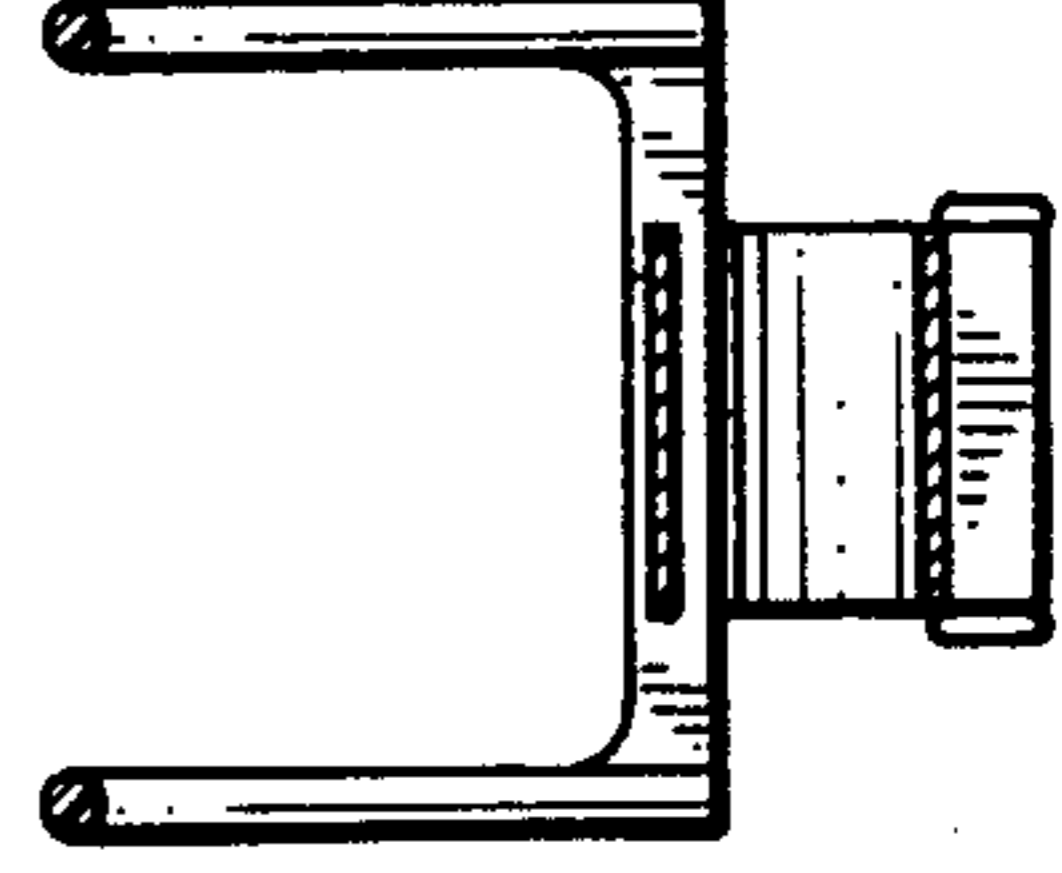

Fig. 6.

