

[54] TOY PIN BALL MACHINE

[56] References Cited

[75] Inventor: Michael I. Satten, New York, N.Y.

FOREIGN PATENT DOCUMENTS

2161963 12/1971 Fed. Rep. of Germany ..... 273/121 R  
2656382 12/1977 Fed. Rep. of Germany ..... 273/121 R  
1422335 11/1965 France ..... 273/121 R

[73] Assignee: Child Guidance Playthings, Inc., New York, N.Y.

Primary Examiner—Melvin B. Feifer  
Attorney, Agent, or Firm—Arthur H. Seidel

[\*\*] Term: 14 Years

[57] CLAIM

The ornamental design for a toy pin ball machine, as shown and described.

[21] Appl. No.: 861,096

DESCRIPTION

[22] Filed: Dec. 15, 1977

FIG. 1 is a top plan view of a toy pin ball machine showing my new design;  
FIG. 2 is a right side view thereof;  
FIG. 3 is a left side view thereof;  
FIG. 4 is a front view thereof;  
FIG. 5 is a rear view thereof; and  
FIG. 6 is a bottom view thereof.

[51] Int. Cl. .... D21-01  
[52] U.S. Cl. .... D21/09  
[58] Field of Search ..... D34/5 JJ; 273/121 A, 273/121 R

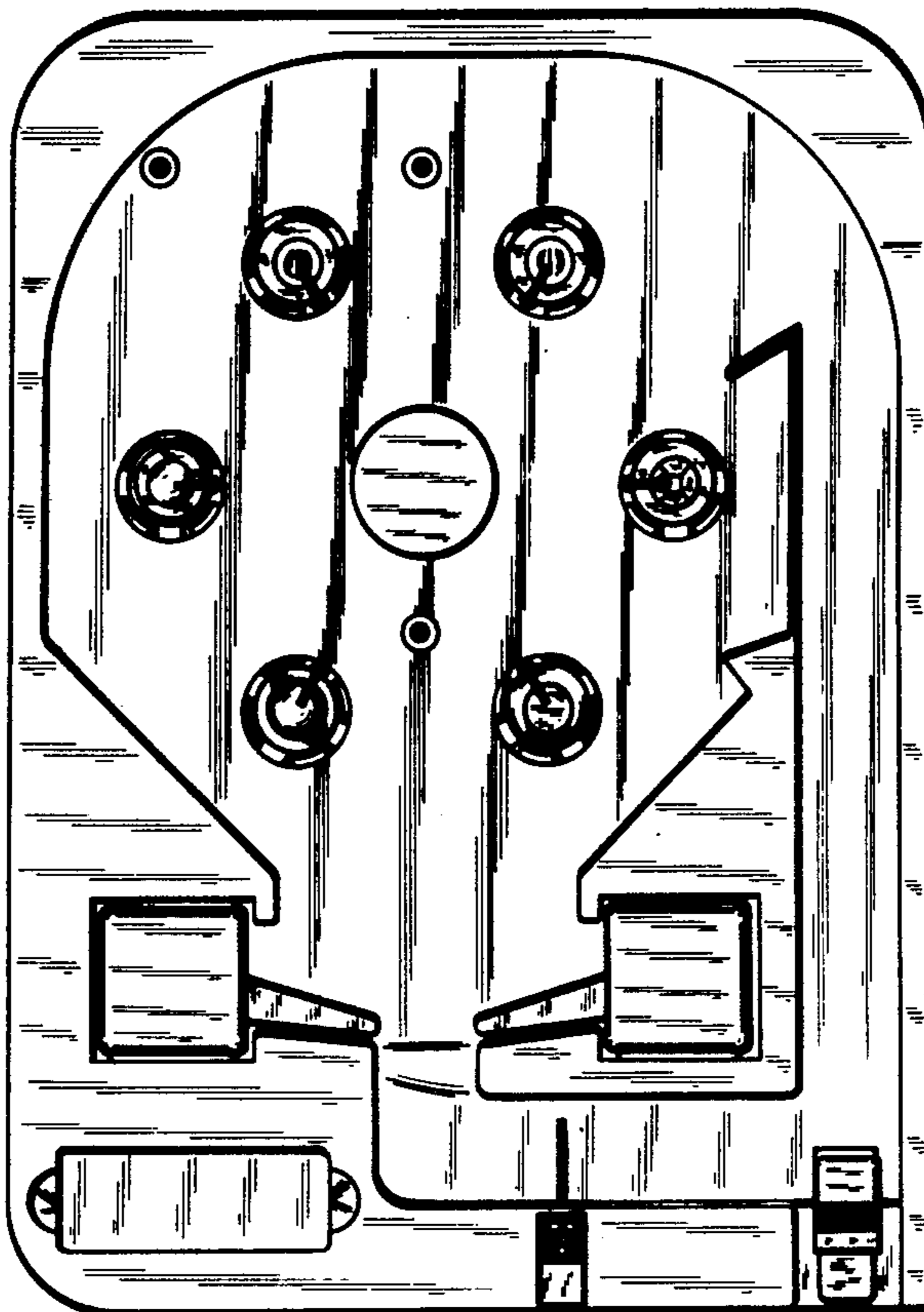

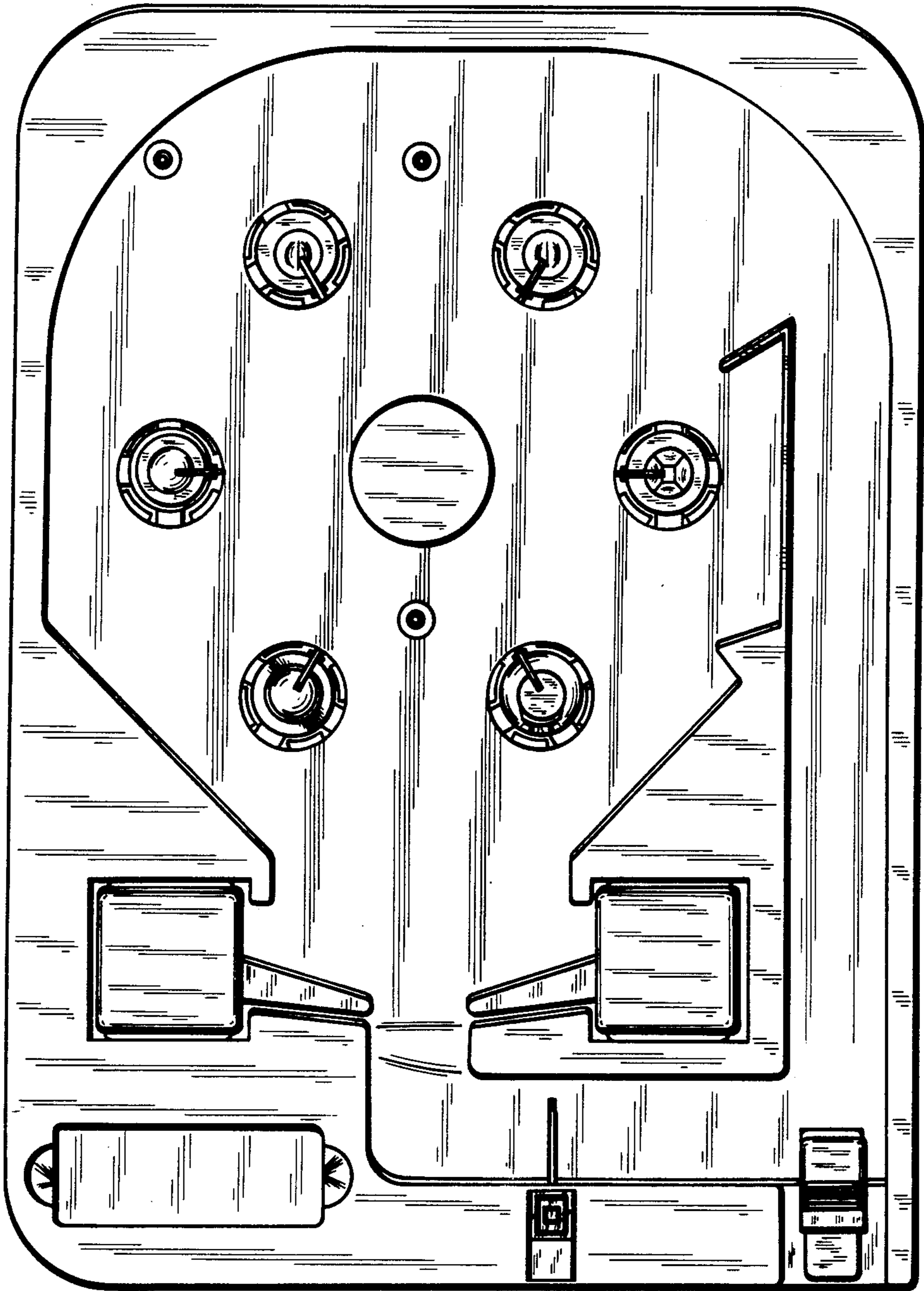

—FIG. 1

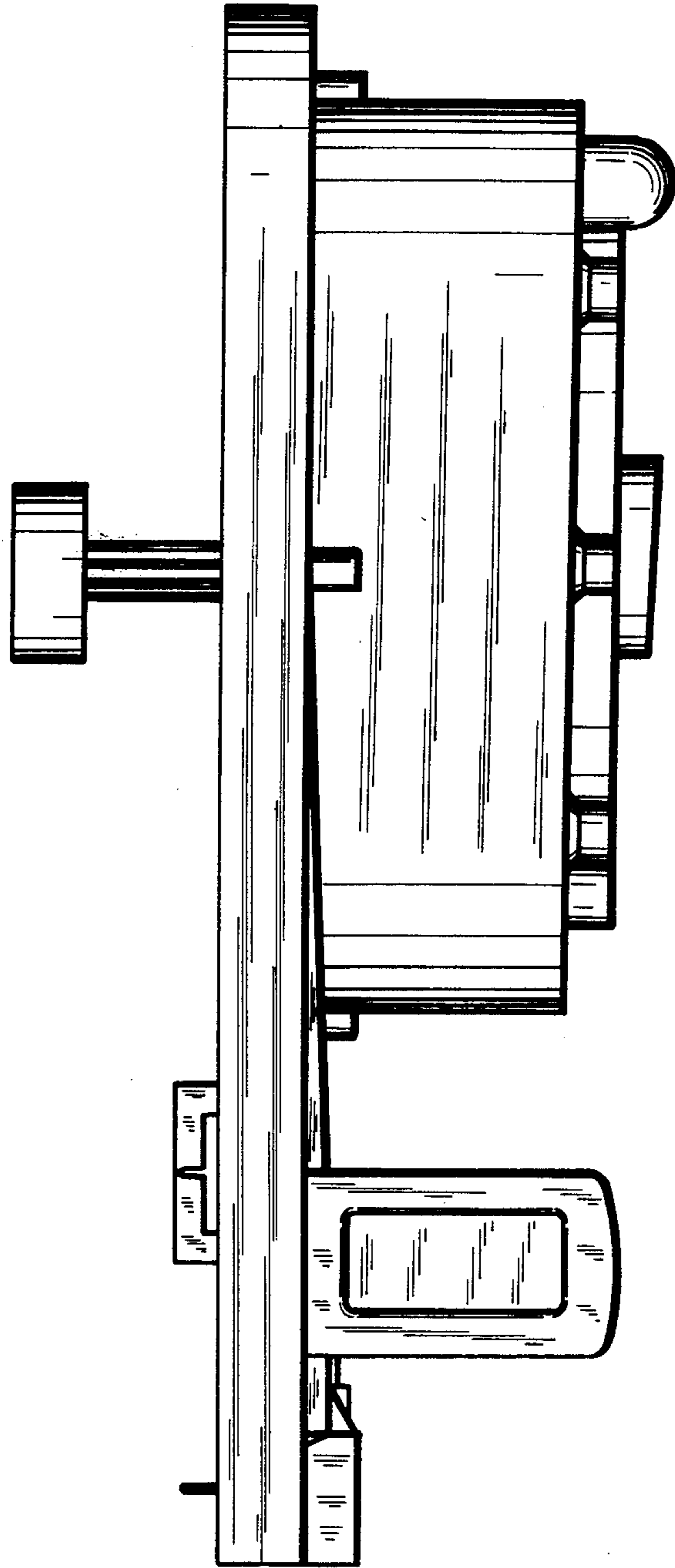

FIG. 2

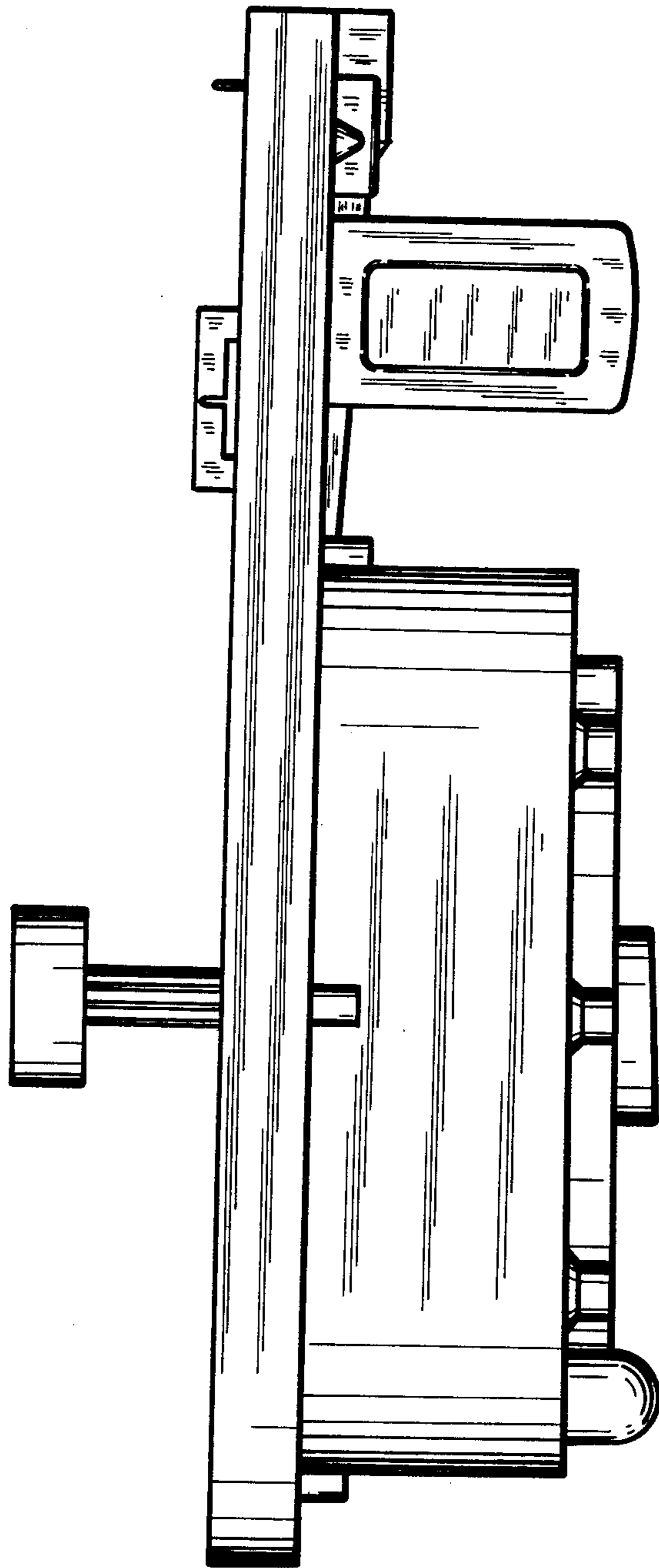
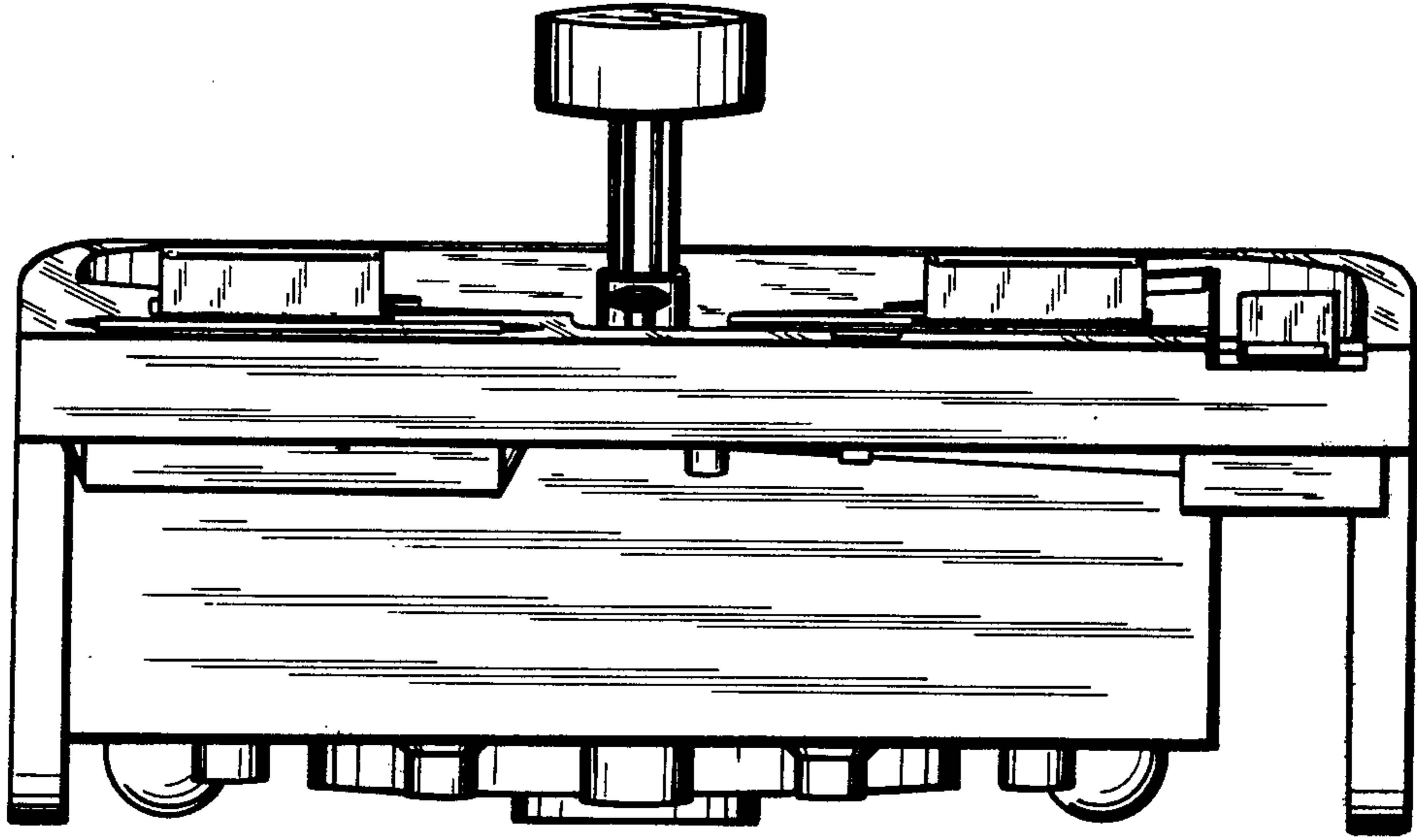
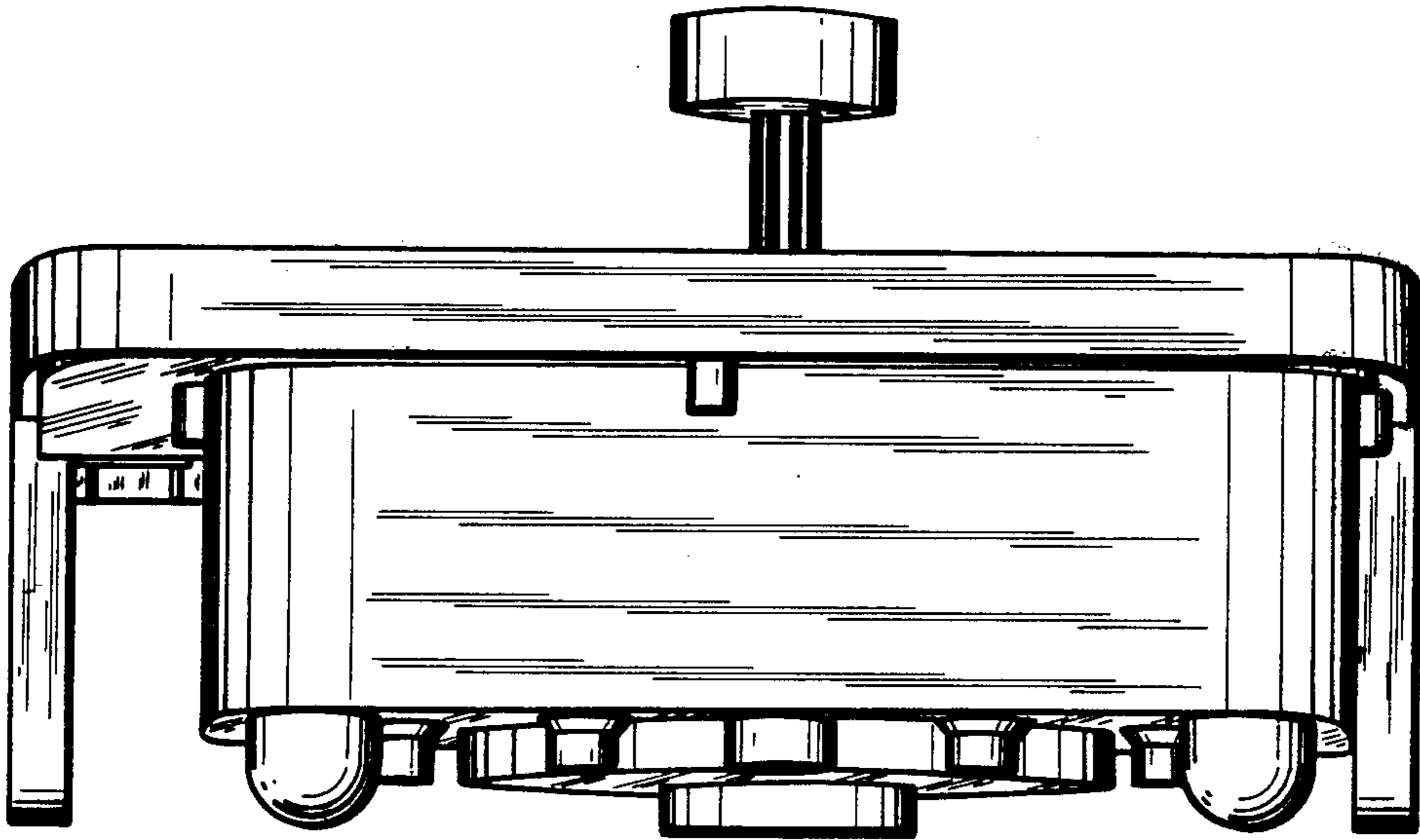

FIG. 3



—FIG. 4



—FIG. 5

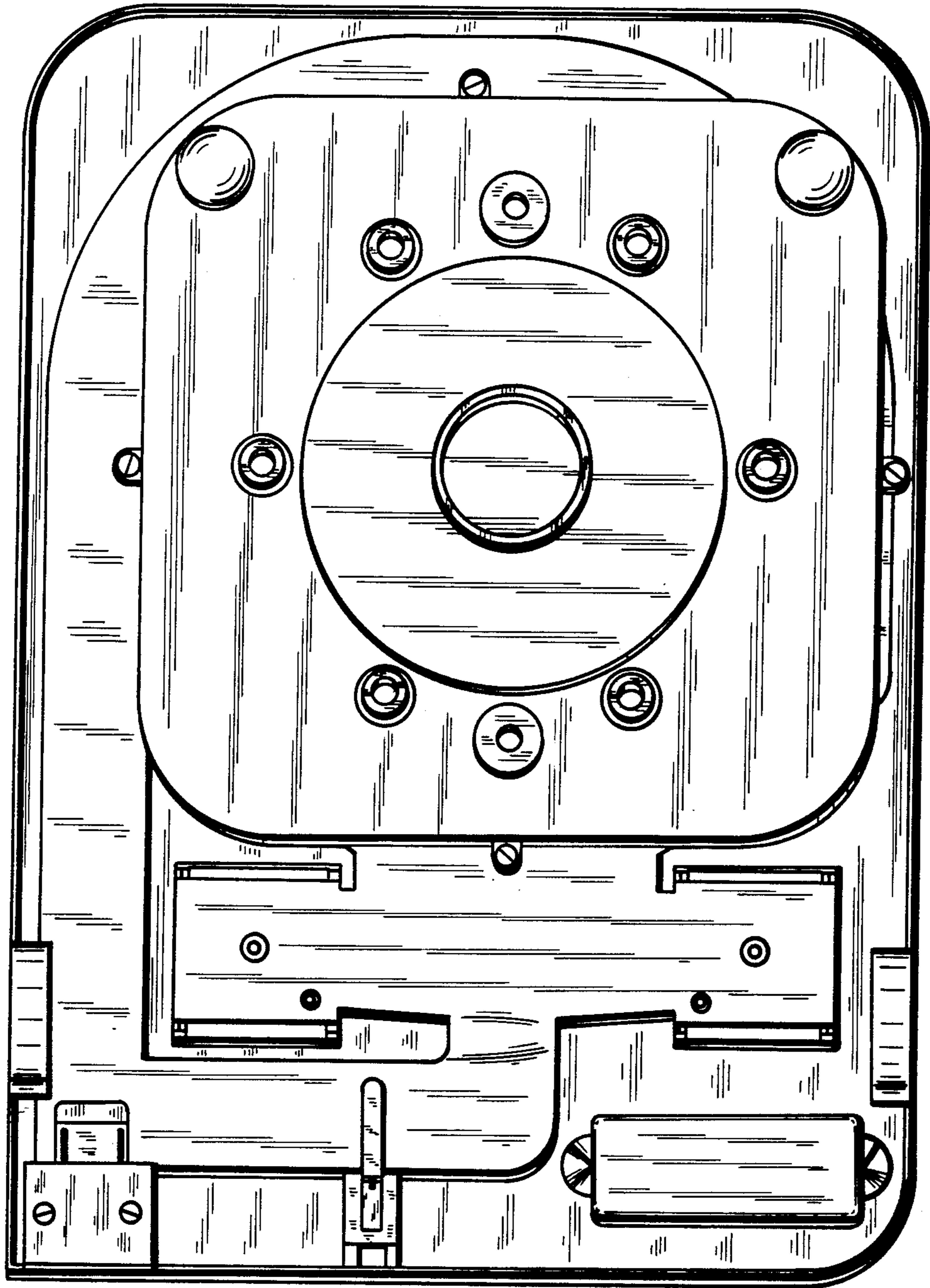

—FIG. 6