

[54] HANDLE FOR A KNIFE OR SIMILAR ARTICLE

[75] Inventor: Merwyn R. Reinschreiber, Cleveland Heights, Ohio

[73] Assignee: Cole National Corporation

[**] Term: 14 Years

[21] Appl. No.: 835,841

[22] Filed: Sep. 22, 1977

[51] Int. Cl. D07—03

[52] U.S. Cl. D7/152; D7/150; D7/151

[58] Field of Search 30/340, 343, 344; D8/98, 99, 100, 107, 95, 96, 97; D7/137, 150, 151, 152, 148, 132

[56] References Cited

U.S. PATENT DOCUMENTS

D. 3,752	11/1869	Seaver	D8/99
D. 43,044	9/1912	Hewitt	D7/148
2,672,685	3/1954	Walters	30/343 X

OTHER PUBLICATIONS

Industrial Design, Apr. 1973, p. 38, item #42, R. Panel-Sportsman's Knife by Bamford.

Better Homes & Gardens, May. 1973, p. Z9, Knife shown in Corning Centura Dinnerware Adv.

Primary Examiner—Winifred E. Herrmann

Attorney, Agent, or Firm—Richard J. Minnich

[57] CLAIM

The ornamental design for a handle for a knife or similar article, as shown and described.

DESCRIPTION

FIG. 1 is a perspective view taken from the top and left end of a handle for a knife or similar article showing my new design;

FIG. 2 is a top plan view thereof;

FIG. 3 is a front elevational view thereof, the rear elevational view being a mirror image thereof;

FIG. 4 is a bottom plan view thereof;

FIG. 5 is an end elevational view on an enlarged scale taken in the direction of lines 5—5 of FIG. 3; and

FIG. 6 is an end elevational view on an enlarged scale taken in the direction of lines 6—6 of FIG. 3.

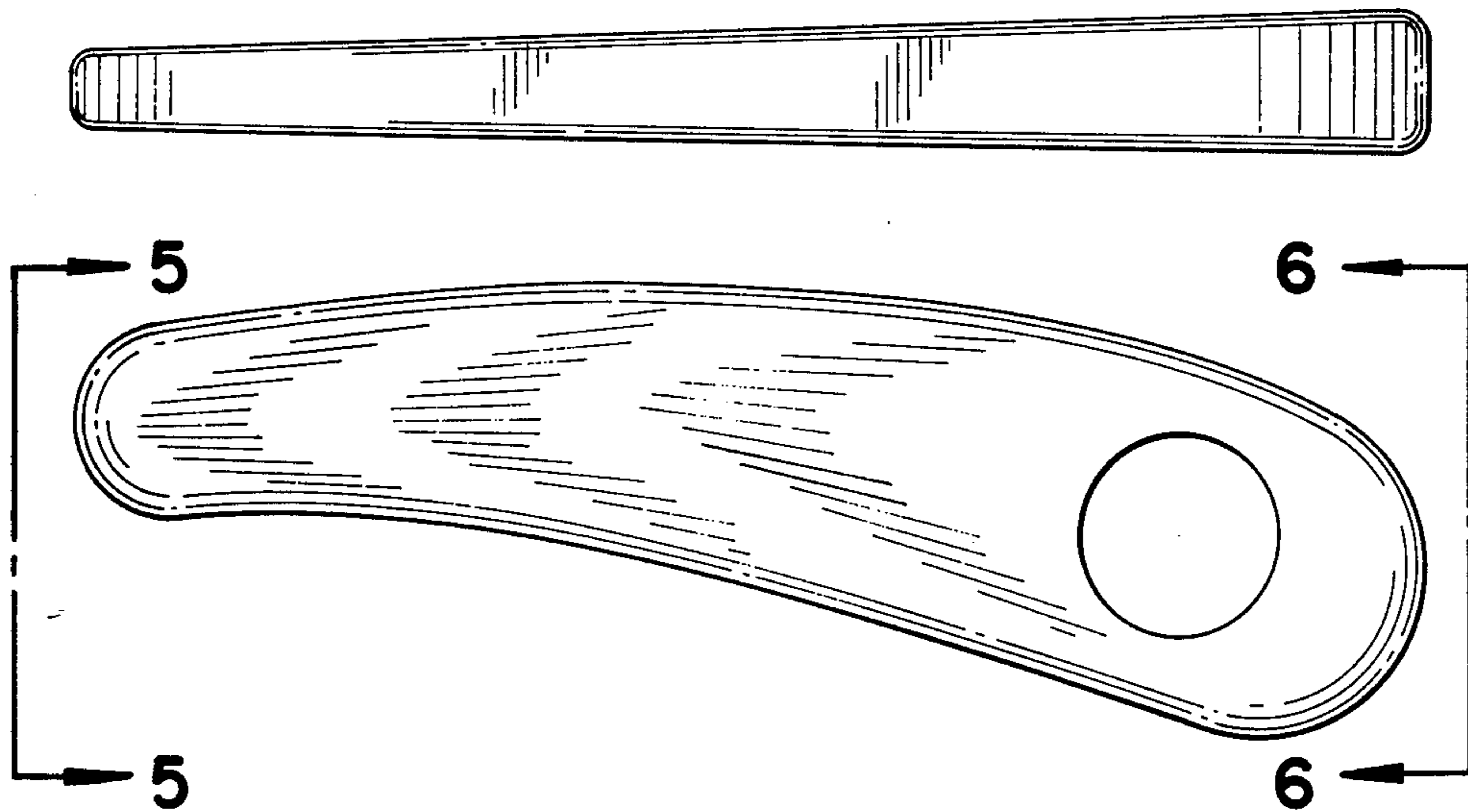

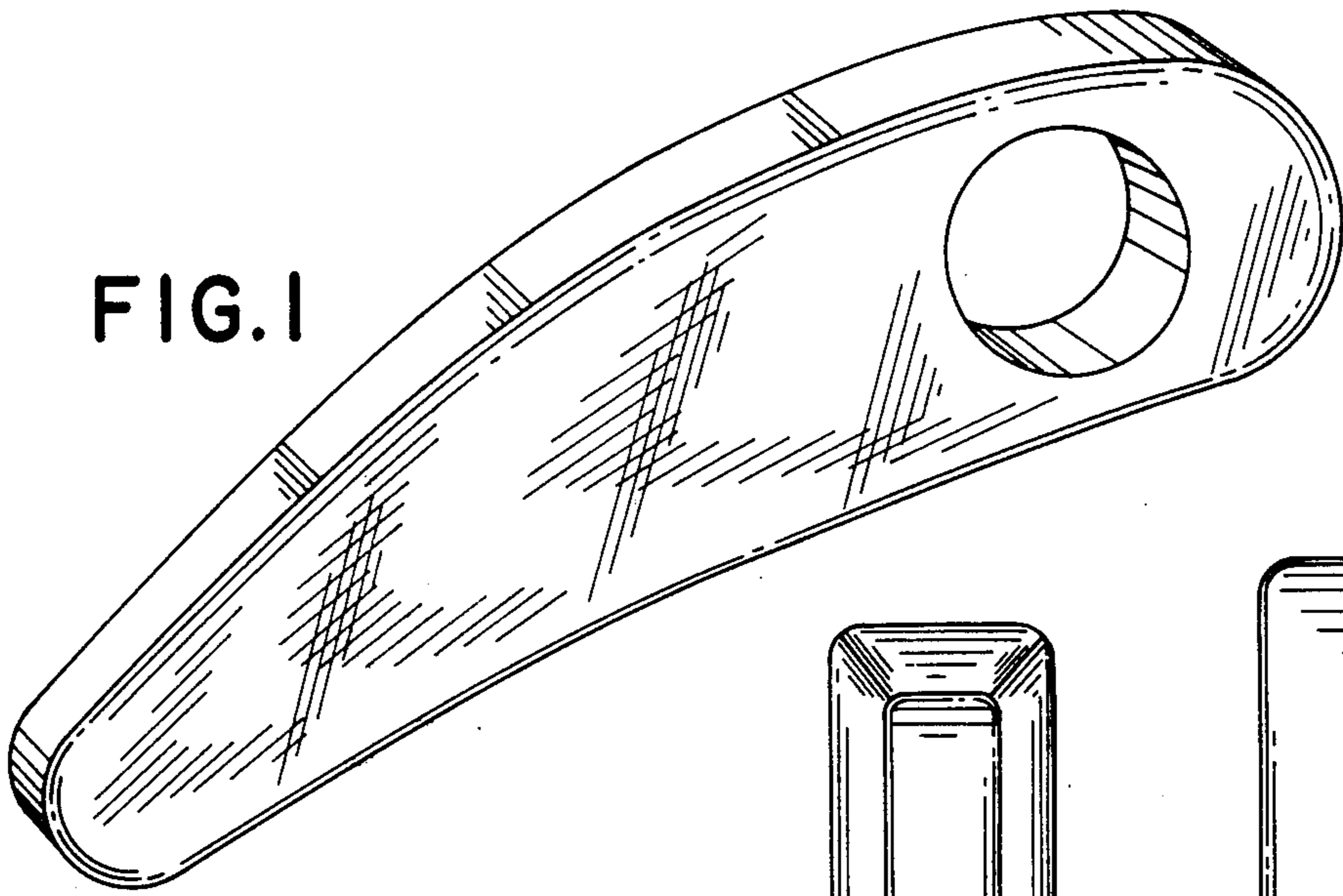

FIG. 1

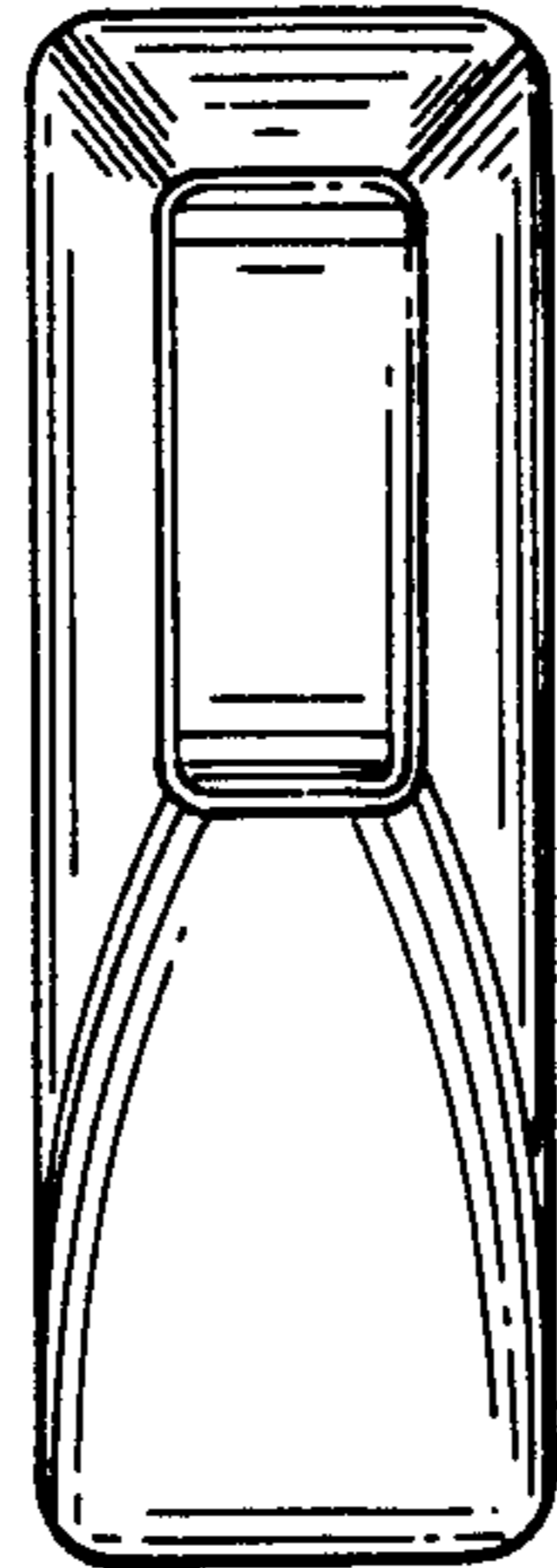

FIG. 5

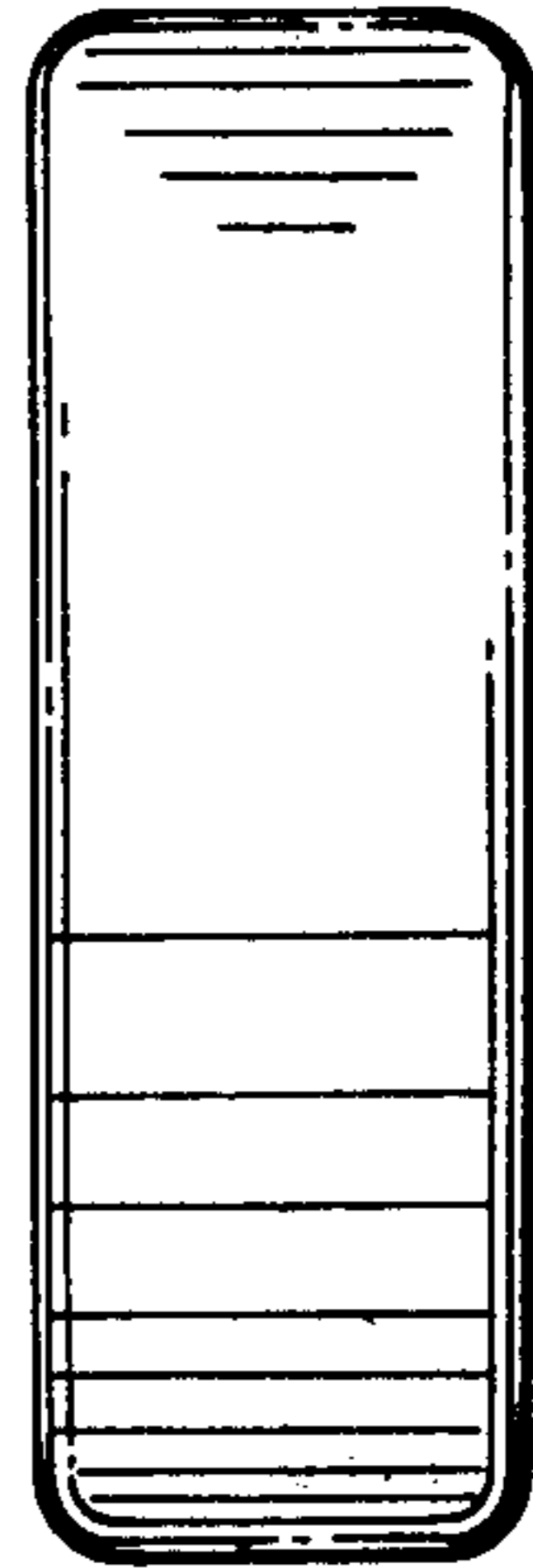

FIG. 6

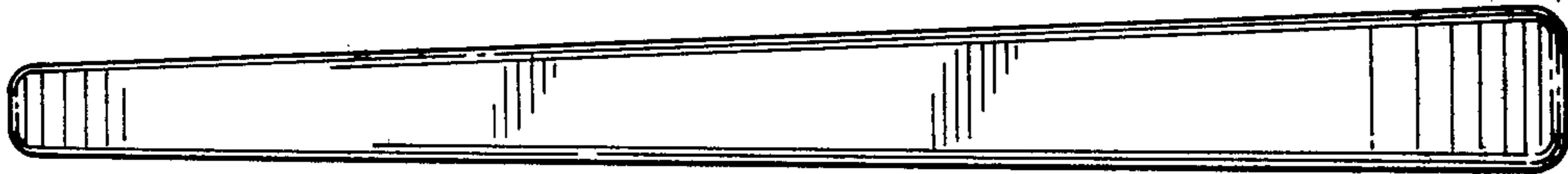

FIG. 2

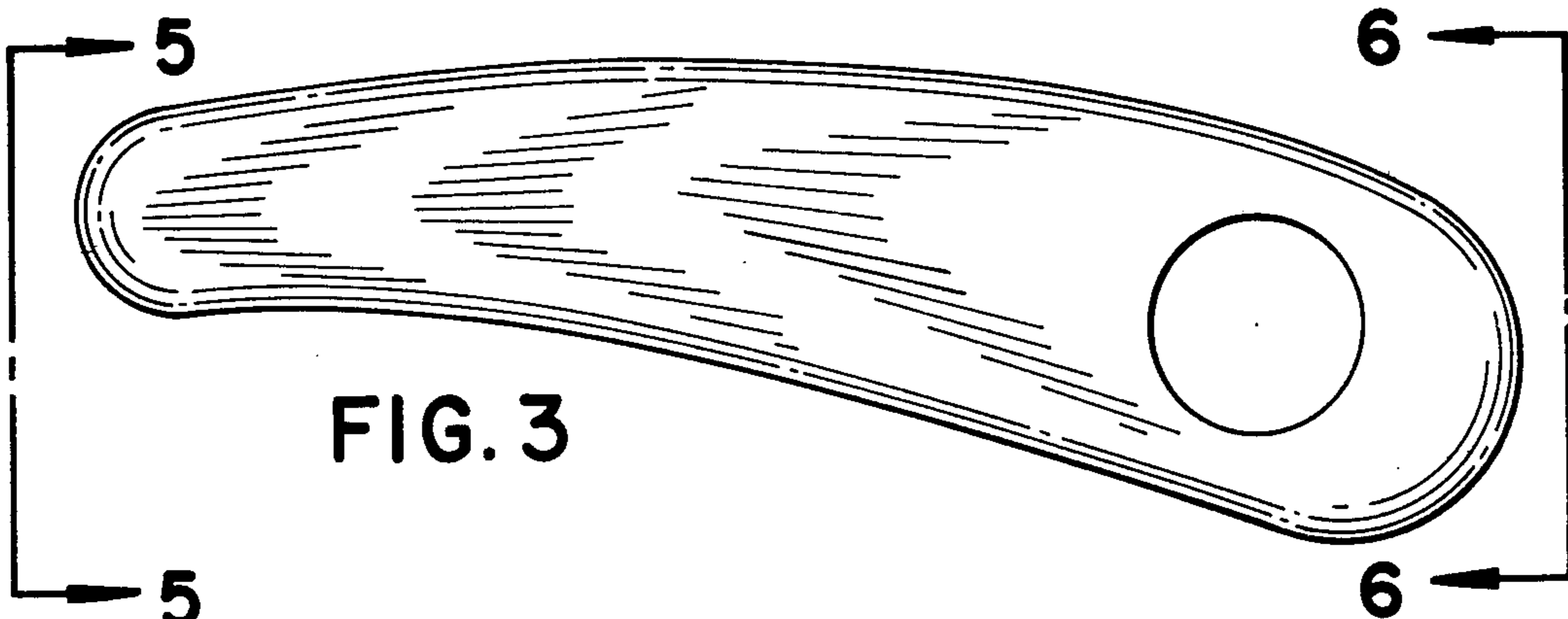

FIG. 3

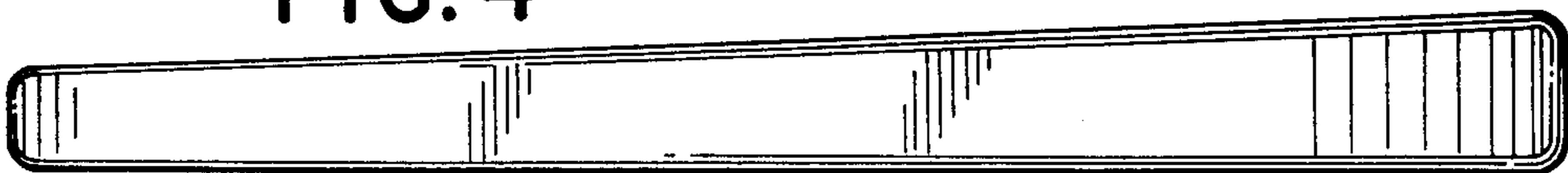

FIG. 4