

[54] **EVAPORATIVE COOLER PUMP**

[76] **Inventor:** Duane K. Johnston, 9041 N. 33rd Way, Phoenix, Ariz. 85028

[\*\*] **Term:** 14 Years

[21] **Appl. No.:** 916,239

[22] **Filed:** Jun. 16, 1978

[51] **Int. Cl.** ..... D15-02

[52] **U.S. Cl.** ..... D15/7

[58] **Field of Search** ..... D15/7, 8, 9; 417/42 A

[56] **References Cited**

**U.S. PATENT DOCUMENTS**

D. 119,404	3/1940	Spiegel	.....	D15/7
D. 242,825	12/1976	Morris	.....	D15/7
1,721,692	7/1929	Carson	.....	D15/7 X

1,883,266 10/1932 Yoder ..... D15/7 X

*Primary Examiner*—James R. Largen  
*Attorney, Agent, or Firm*—H. Gordon Shields

[57] **CLAIM**

The ornamental design for an evaporative cooler pump, as shown.

**DESCRIPTION**

FIG. 1 is a perspective view taken from the top, rear and right side of an evaporative cooler pump showing my new design;

FIG. 2 is a top view thereof;

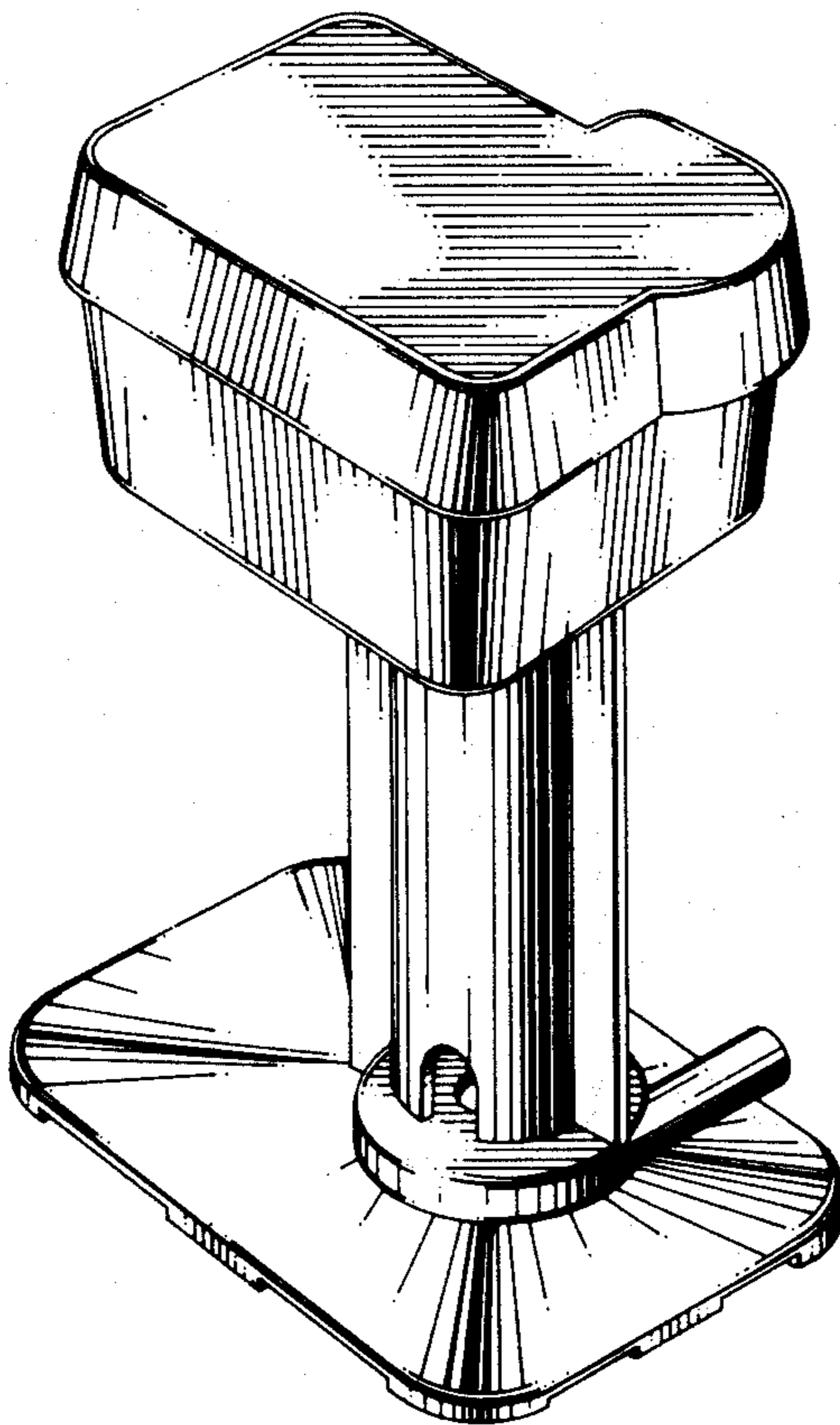
FIG. 3 is a bottom view thereof;

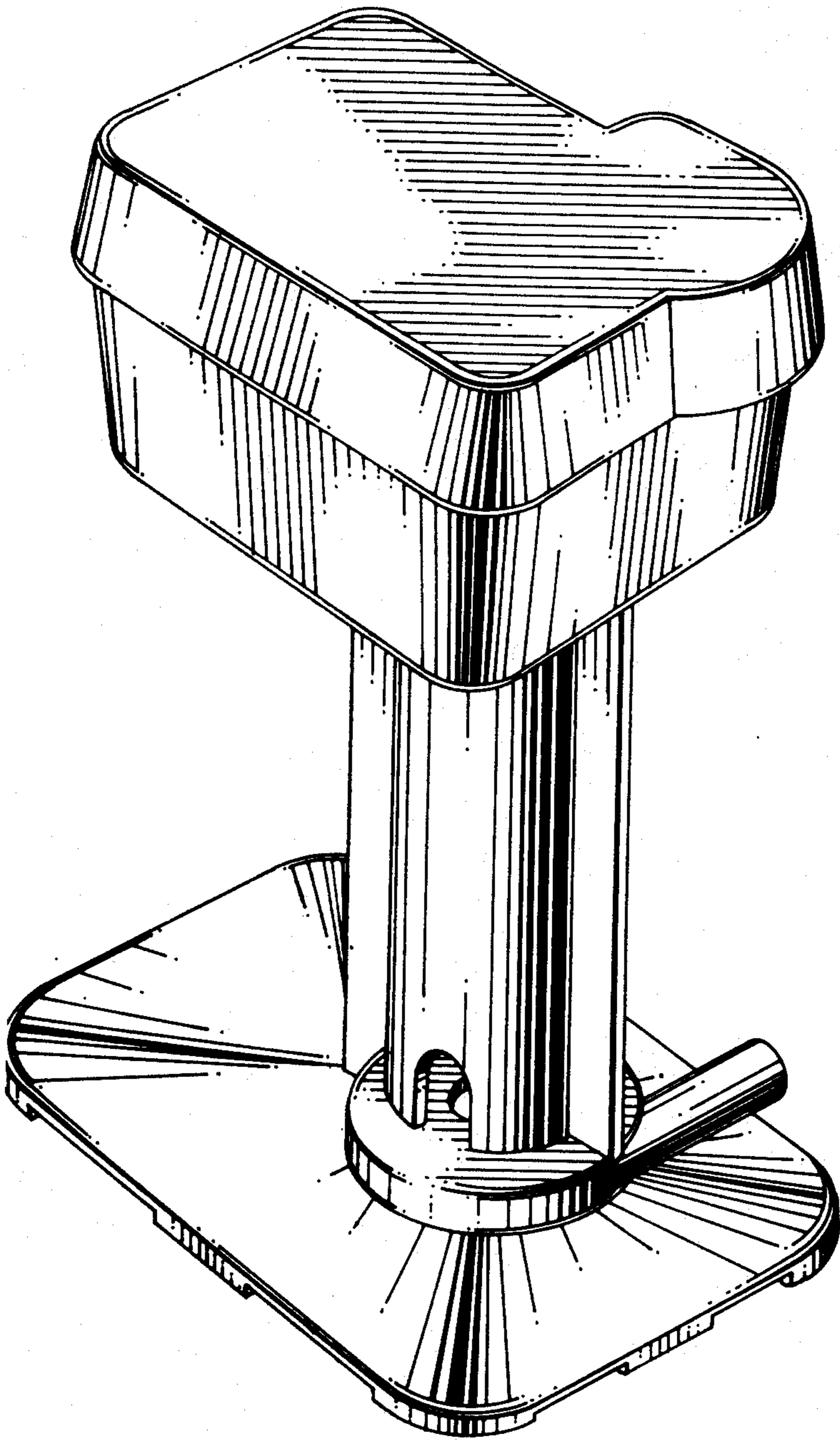
FIG. 4 is a perspective view taken from the bottom, front and left side thereof;

FIG. 5 is a left side elevational view thereof;

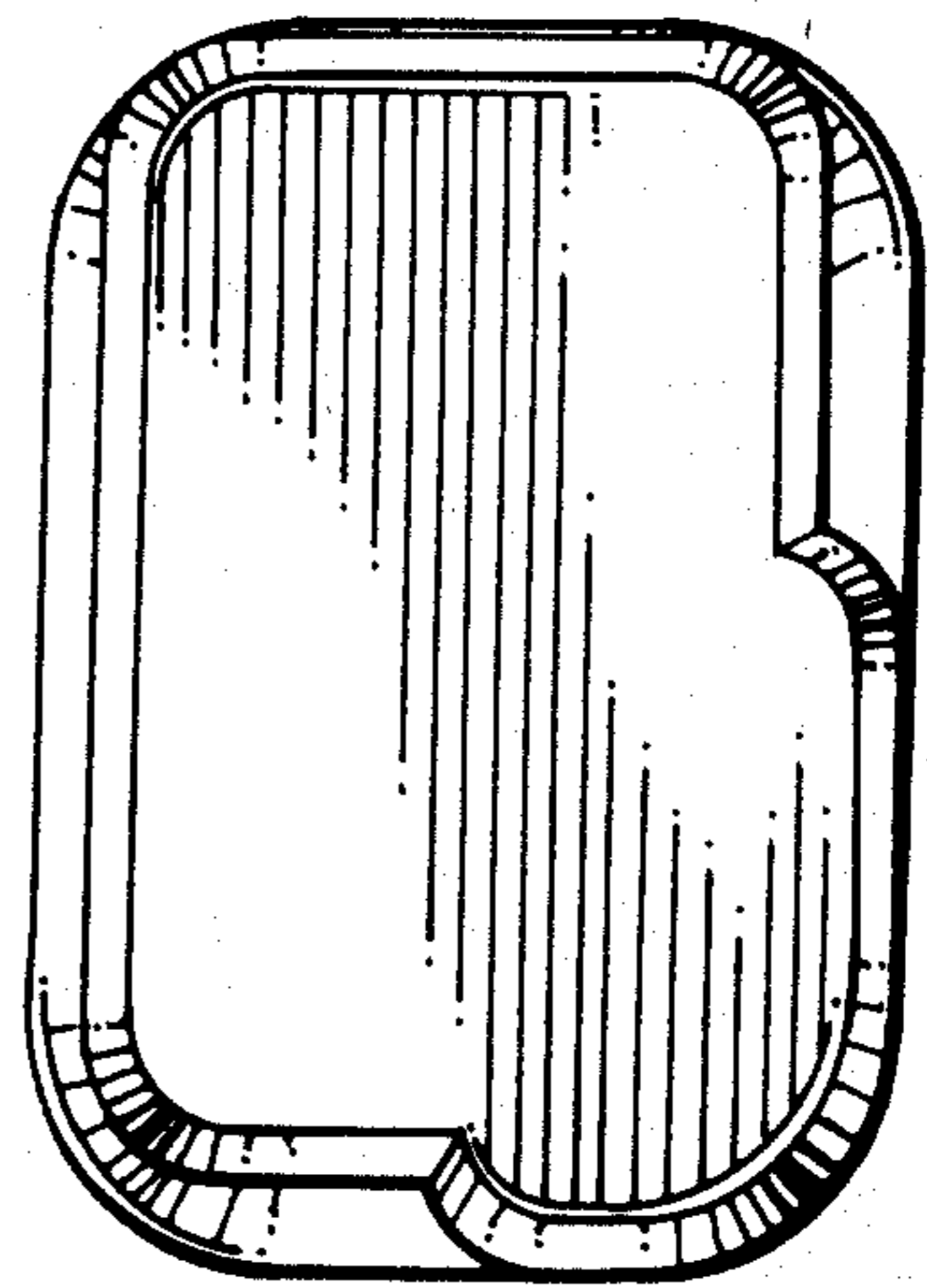
FIG. 6 is a right side elevational view thereof; and

FIG. 7 is a rear elevational view thereof.

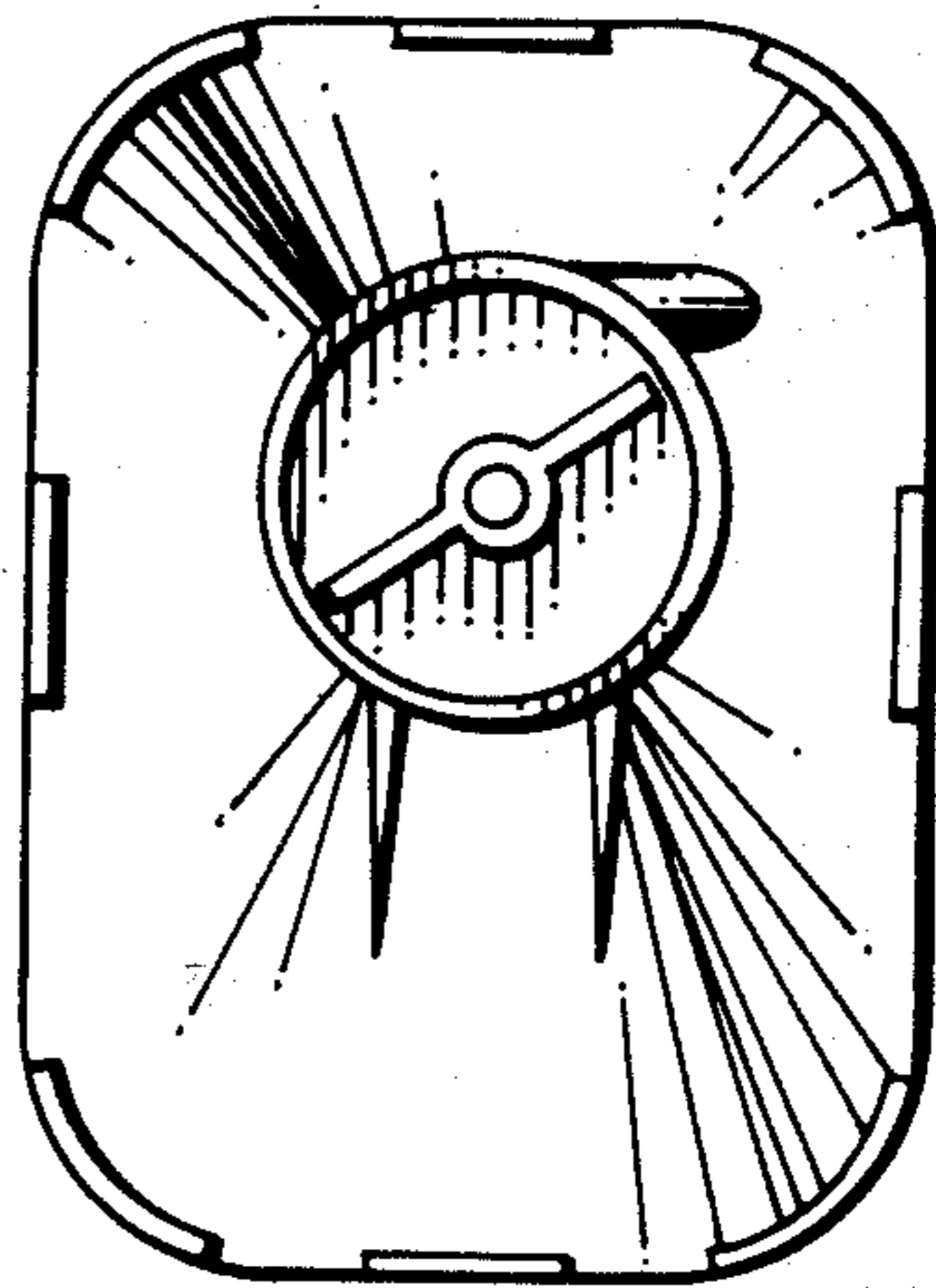




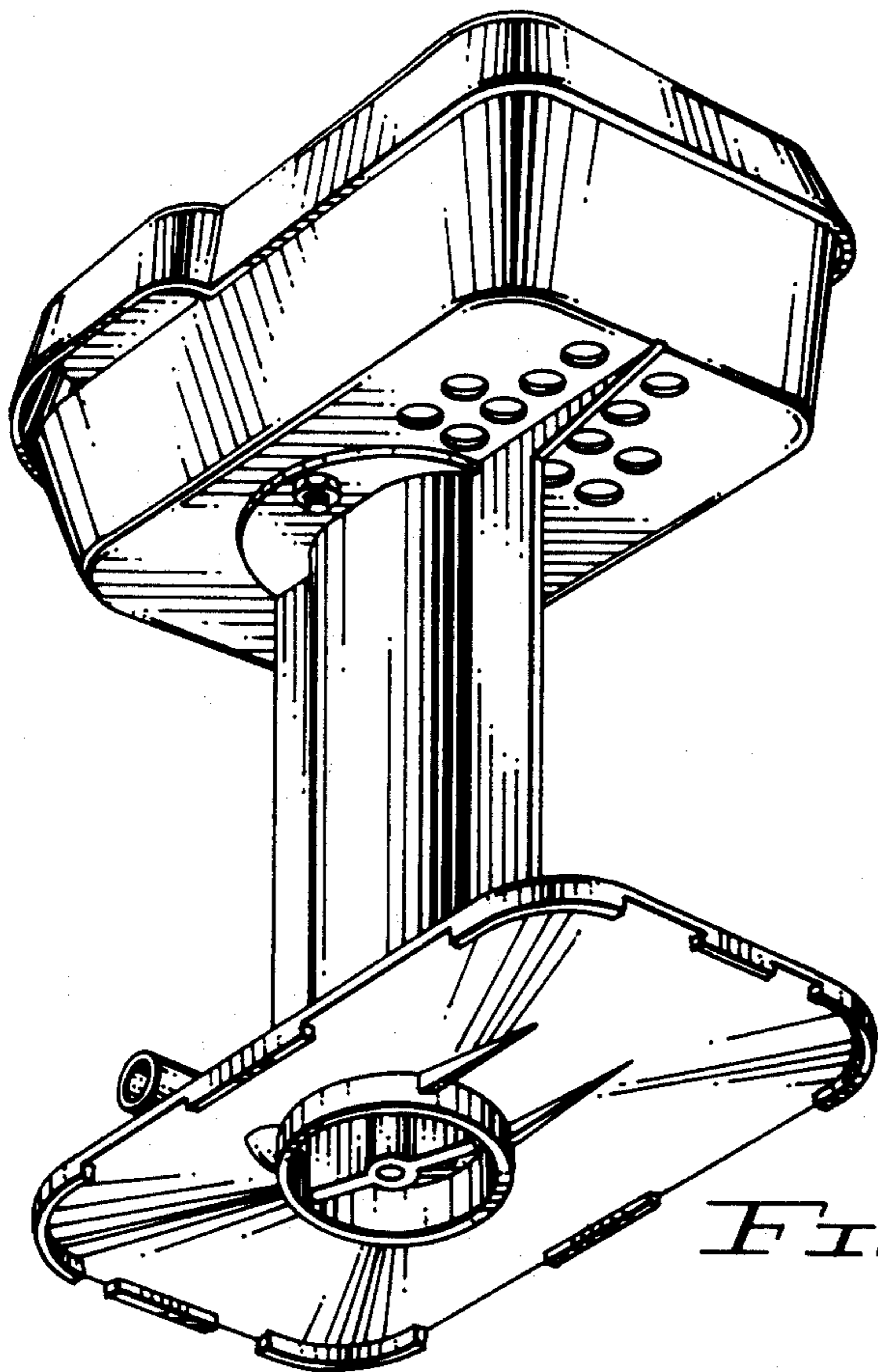
*FIG. 1*



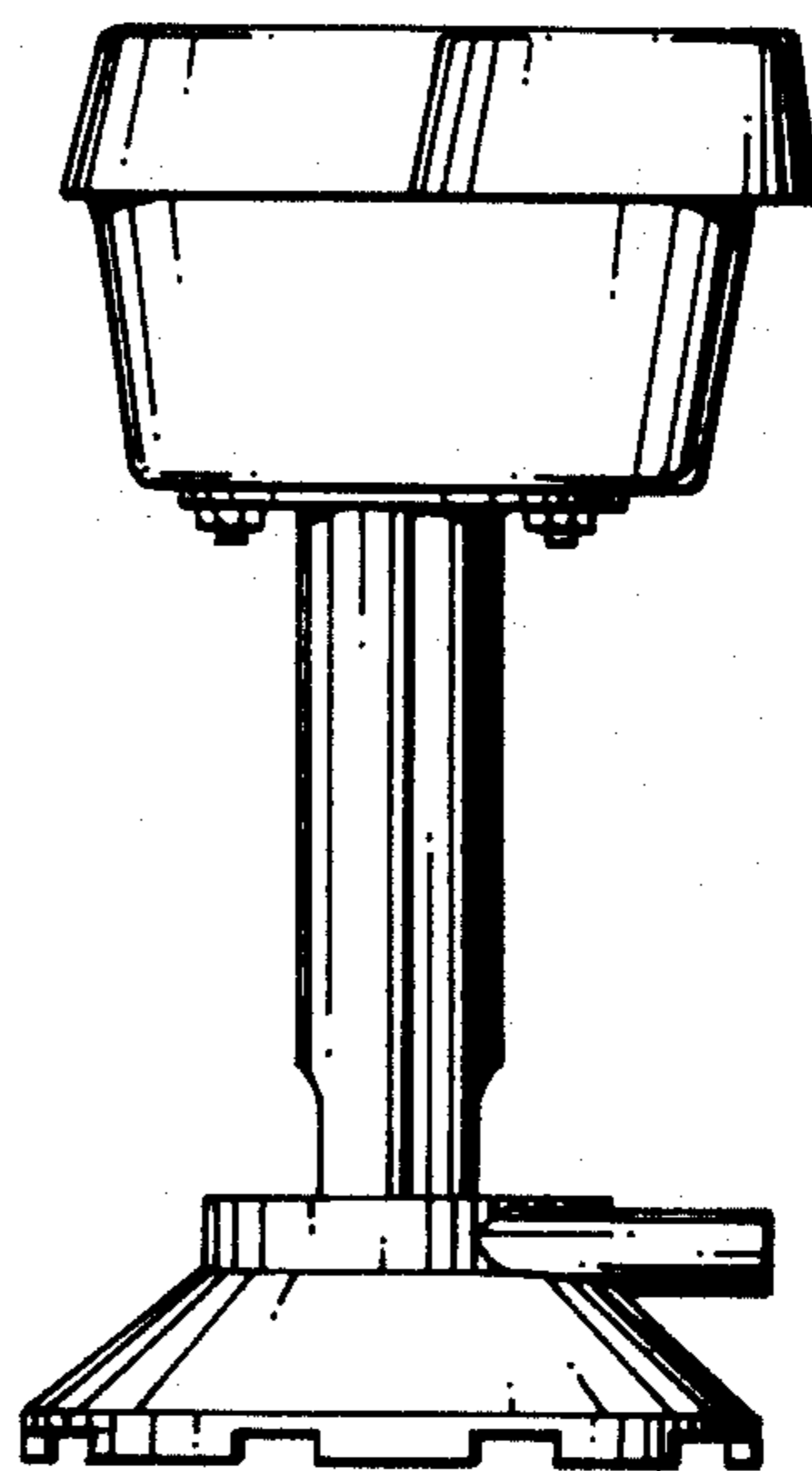
*FIG. 2*



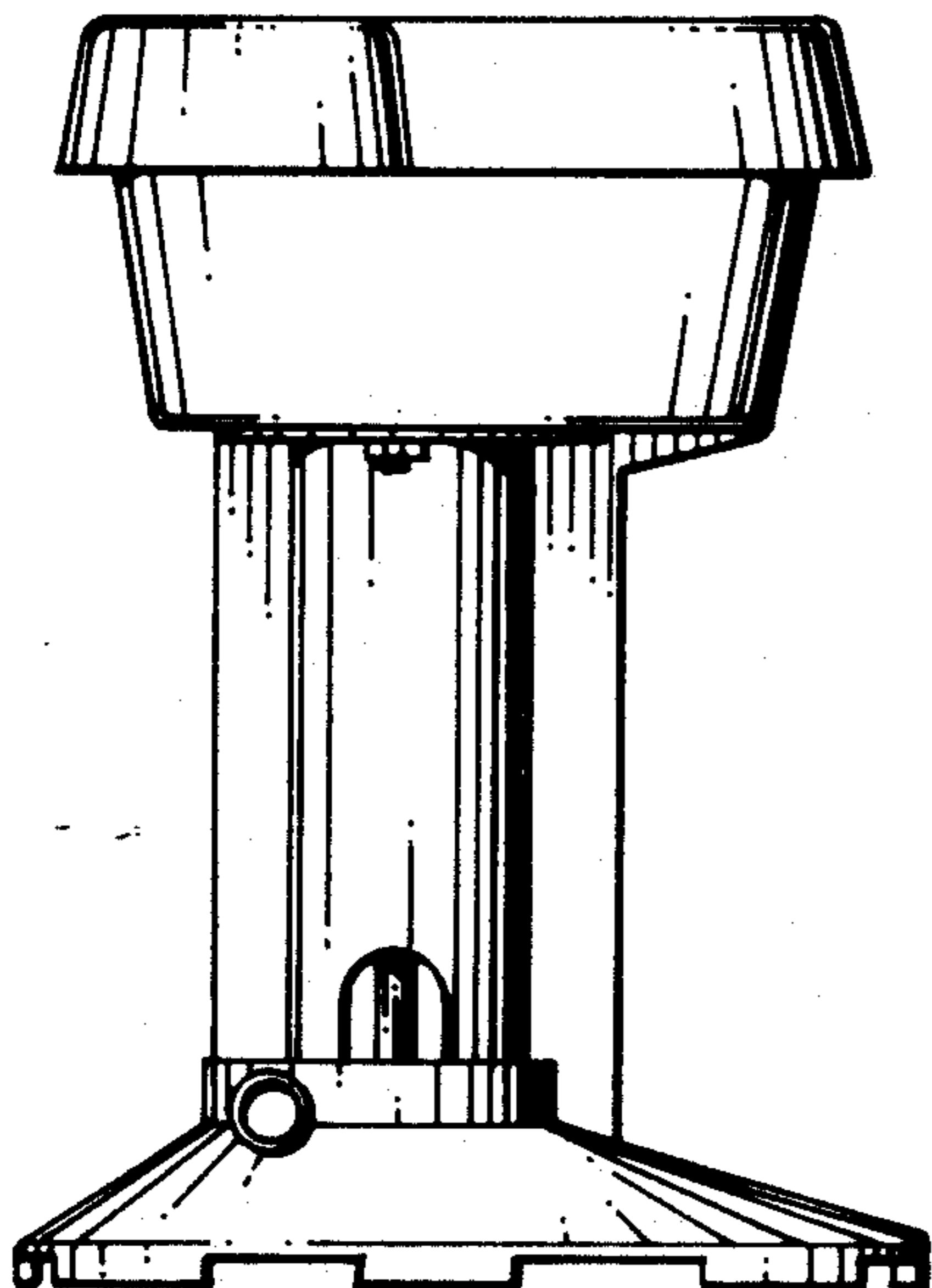
*FIG. 3*



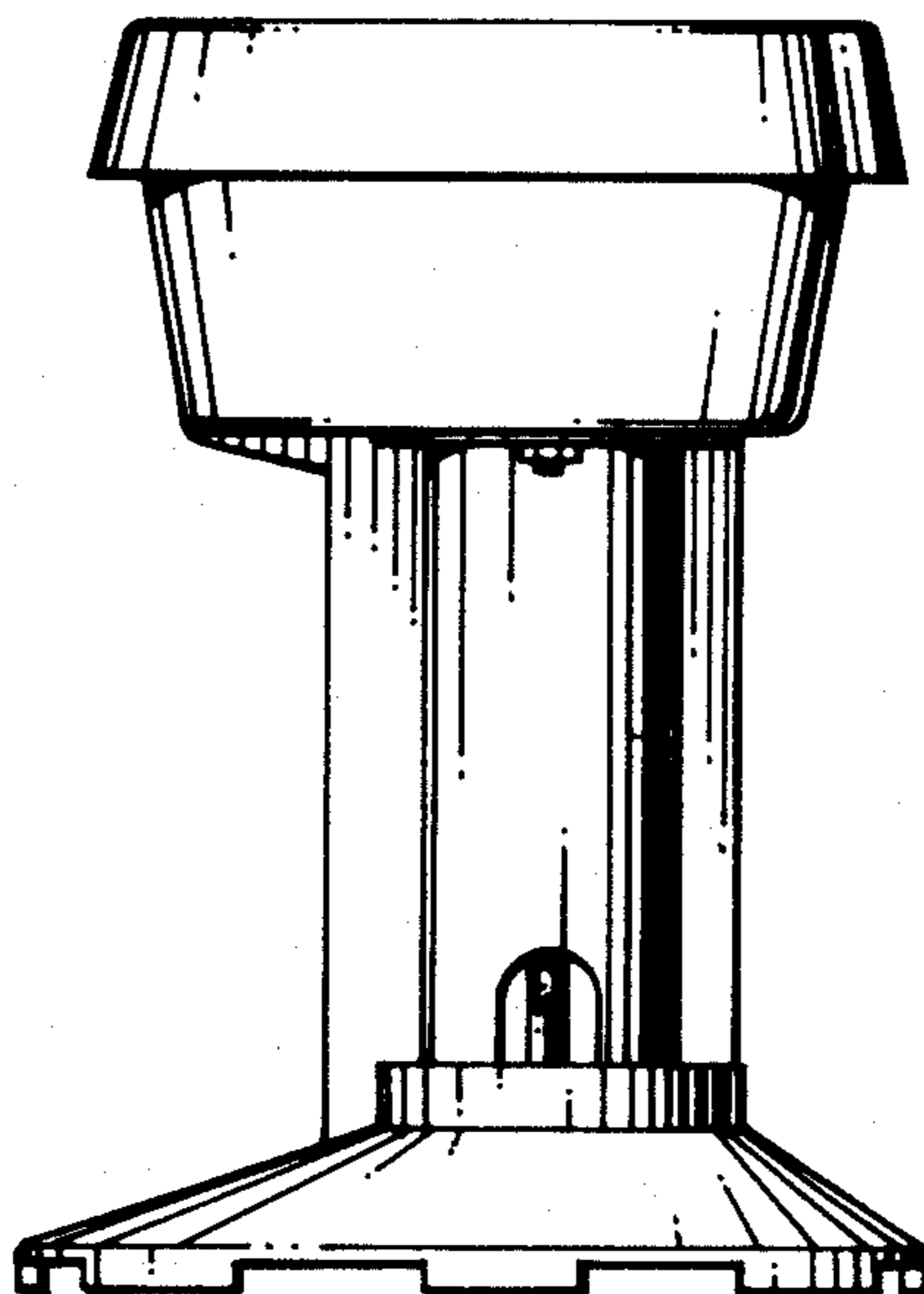
*FIG. 4*



*FIG. 7*



*FIG. 5*



*FIG. 6*