

[54] CONTROL CONSOLE

[75] Inventor: Wayne A. Current, Holmdel, N.J.

[73] Assignee: The Singer Company

[\*\*] Term: 14 Years

[21] Appl. No.: 789,167

[22] Filed: Apr. 20, 1977

[51] Int. Cl. .... D13-03; D14-02

[52] U.S. Cl. .... D13/12; D14/40; D14/43

[58] Field of Search ..... D13/12, 32, 35, 37, D13/38, 40, 41; 112/277; D14/40, 43; 200/5 R, 5 A, 6 R, 293, 294, 296, 298, 302, 303, 308, 310, 315; 174/52 R; 361/331, 334, 344, 346, 356, 358

[56] References Cited

U.S. PATENT DOCUMENTS

D. 239,030 3/1976 Genaro et al. .... D14/43  
3,739,734 6/1973 Princiotta ..... 112/277

OTHER PUBLICATIONS

Bobbin, Jan. 1977, p. 15, Touch-Control Panel for Sewing Machine.

Primary Examiner—Susan J. Lucas  
Attorney, Agent, or Firm—Robert E. Smith

[57] CLAIM

The ornamental design for a control console, substantially as shown and described.

DESCRIPTION

FIG. 1 is a front perspective view of a control console embodying my new design;  
FIG. 2 is a rear elevational view thereof on an enlarged scale;  
FIG. 3 is a front elevational view thereof on an enlarged scale;  
FIG. 4 is a side elevational view thereof on an enlarged scale as seen from the left side of FIG. 1;  
FIG. 5 is the other side elevational view thereof on an enlarged scale;  
FIG. 6 is a top plan view thereof on an enlarged scale; and  
FIG. 7 is a bottom plan view thereof on an enlarged scale.

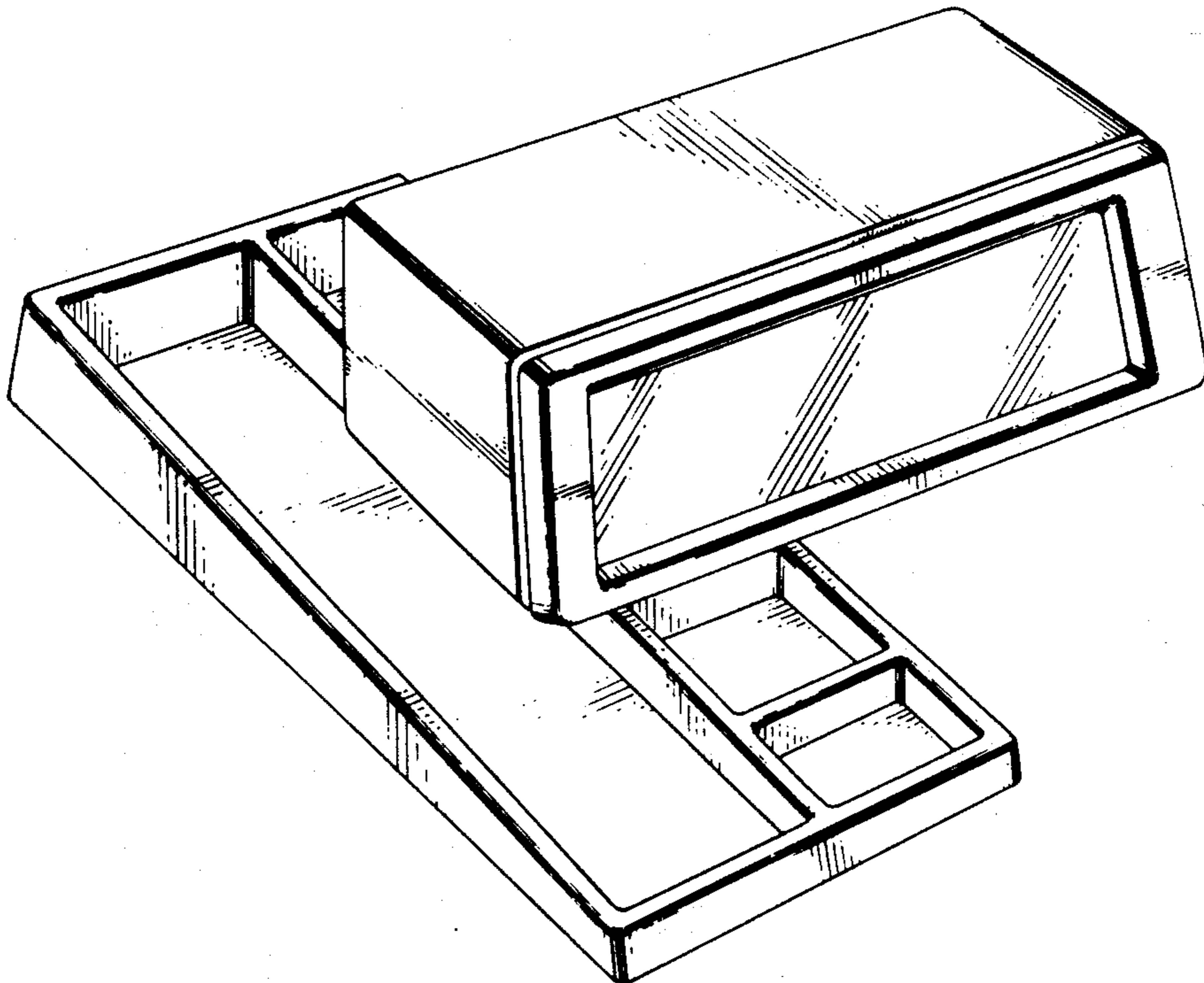

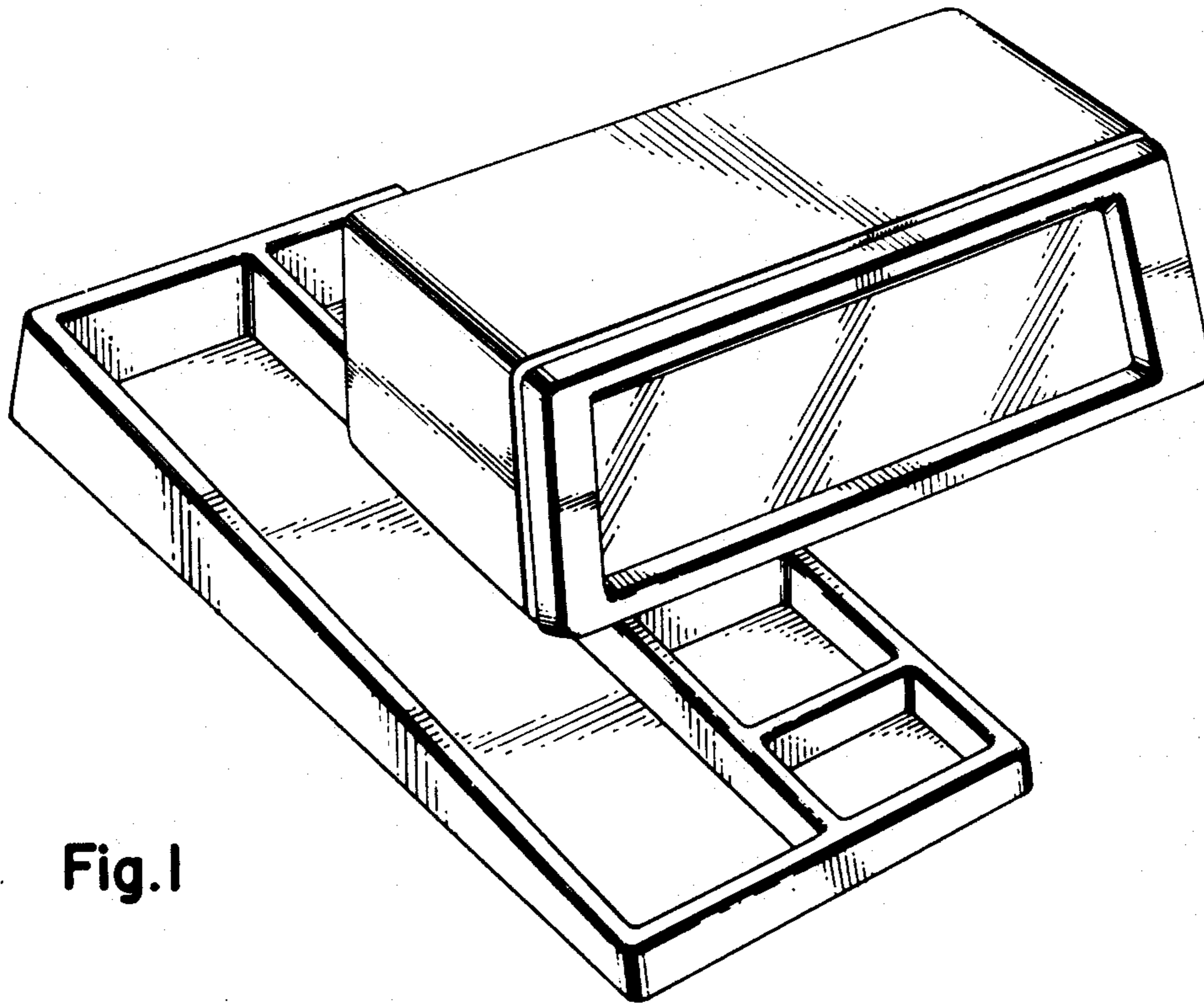

Fig. 1

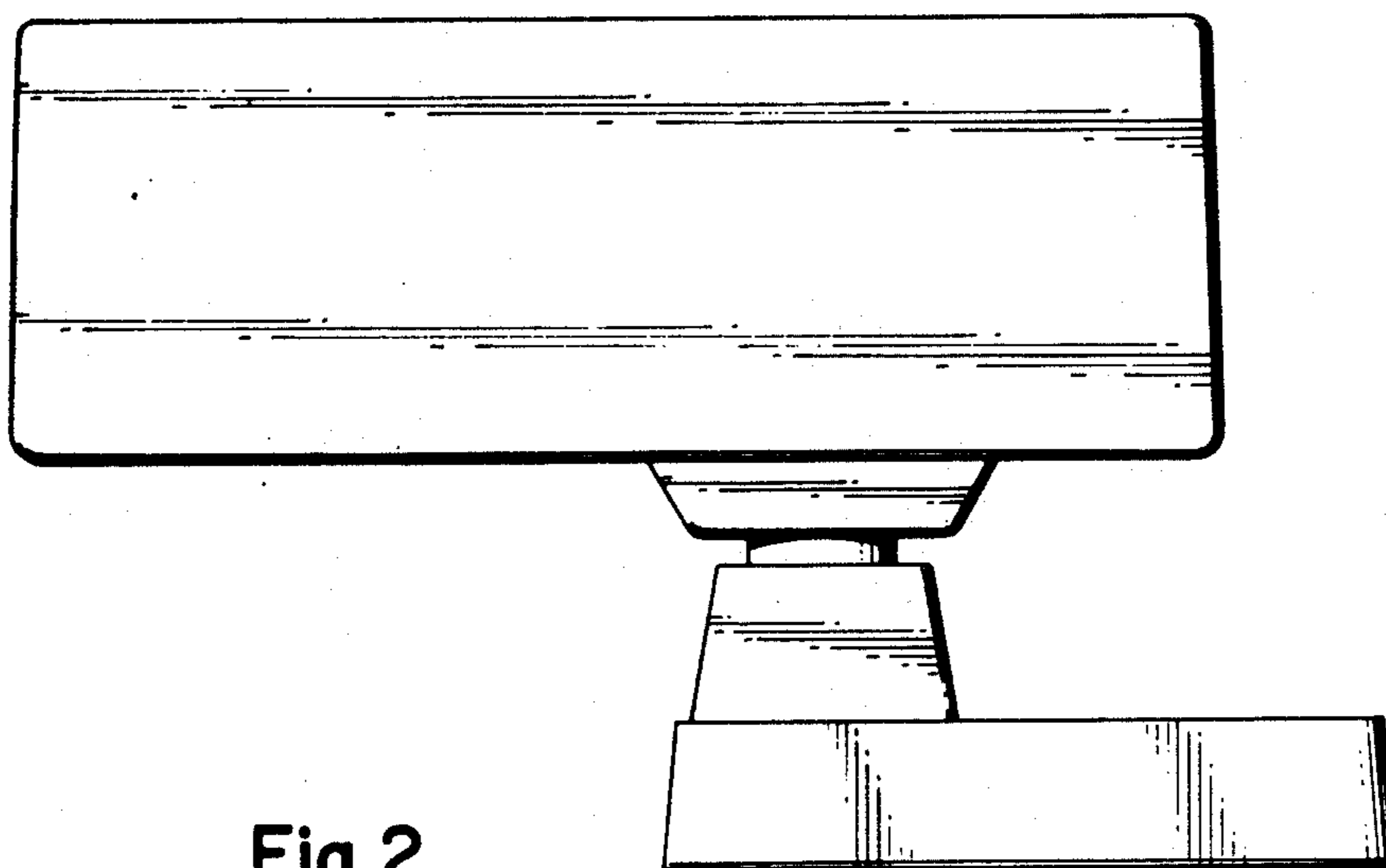

Fig. 2

Fig.3

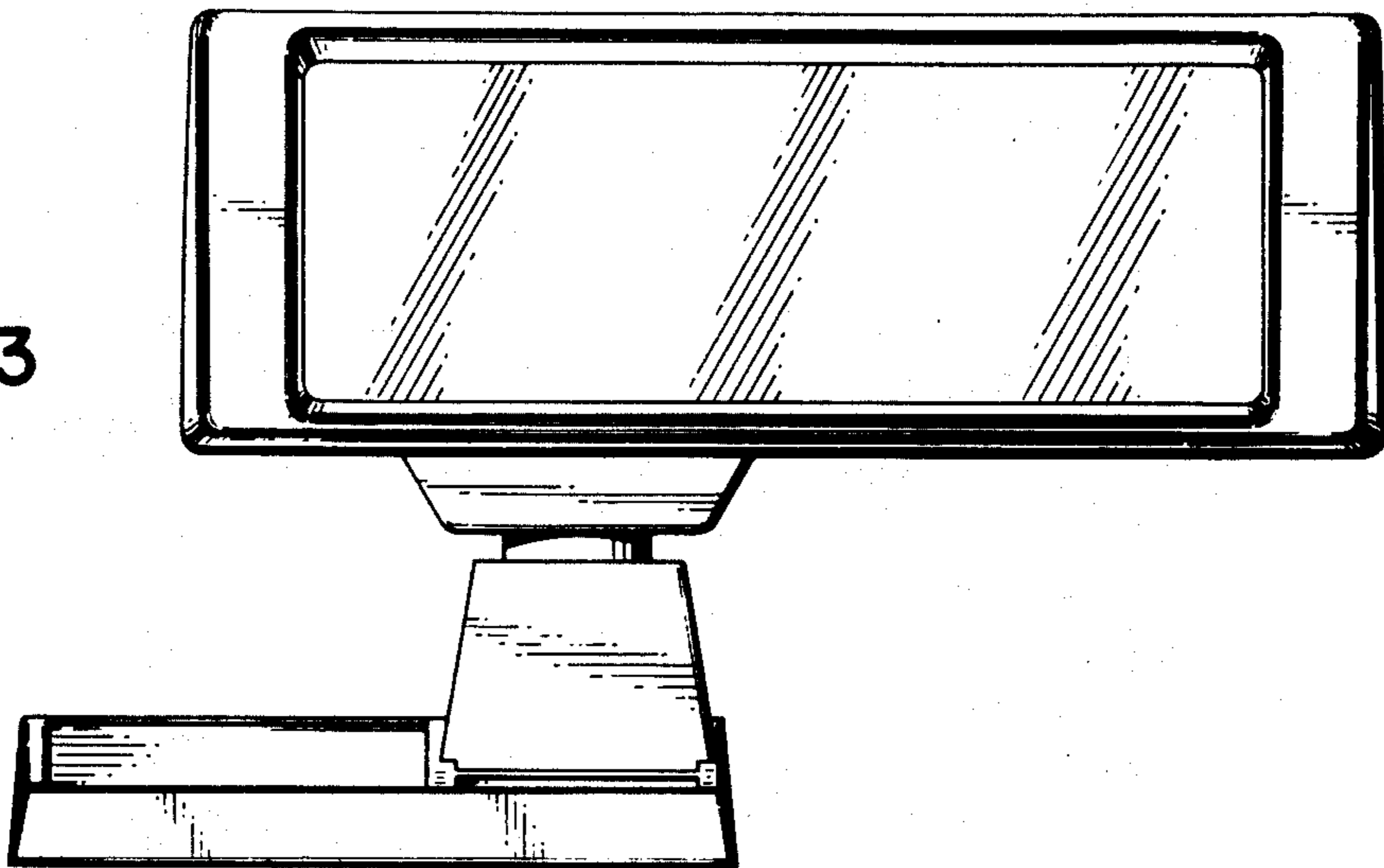

Fig.4

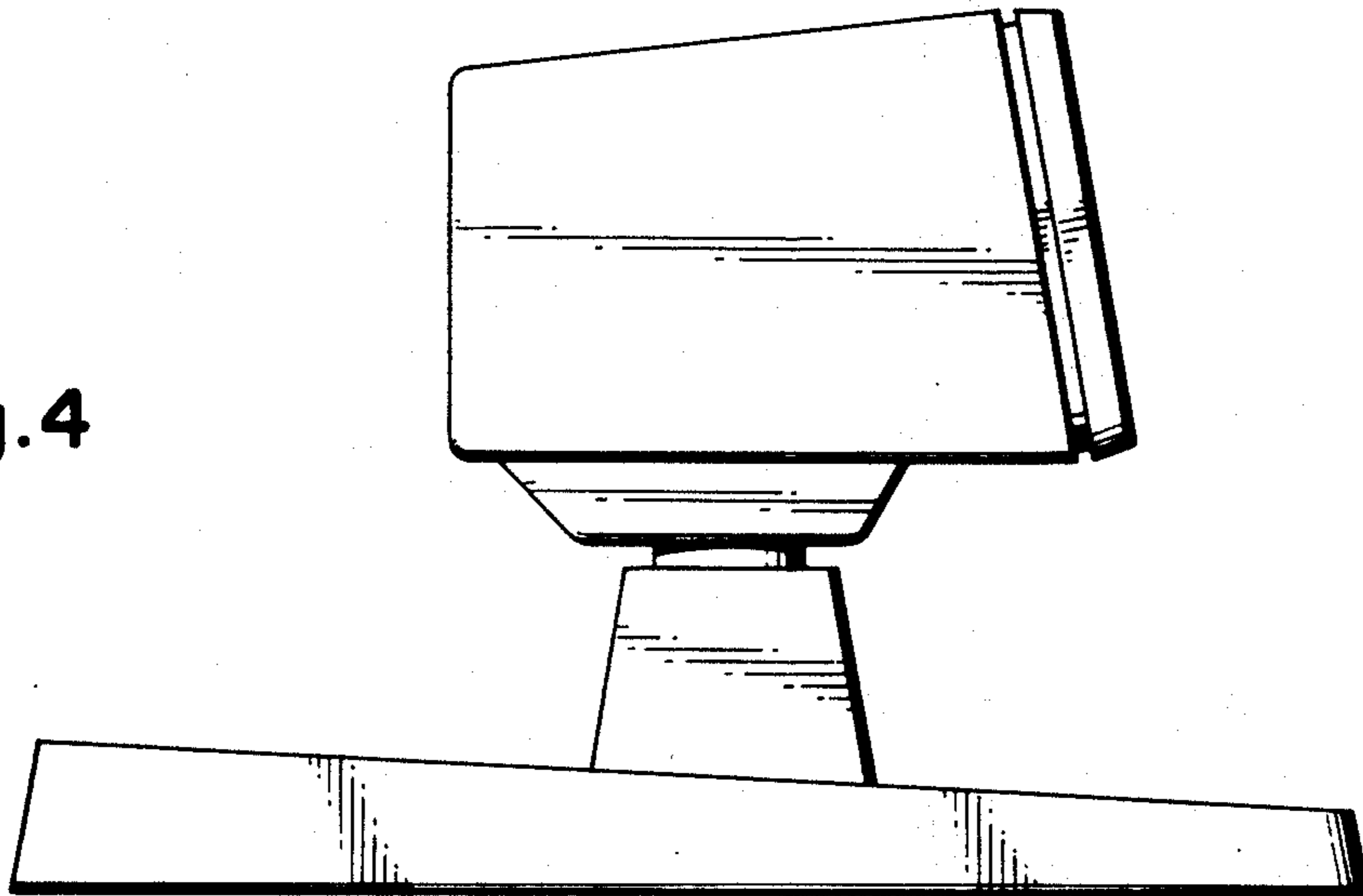
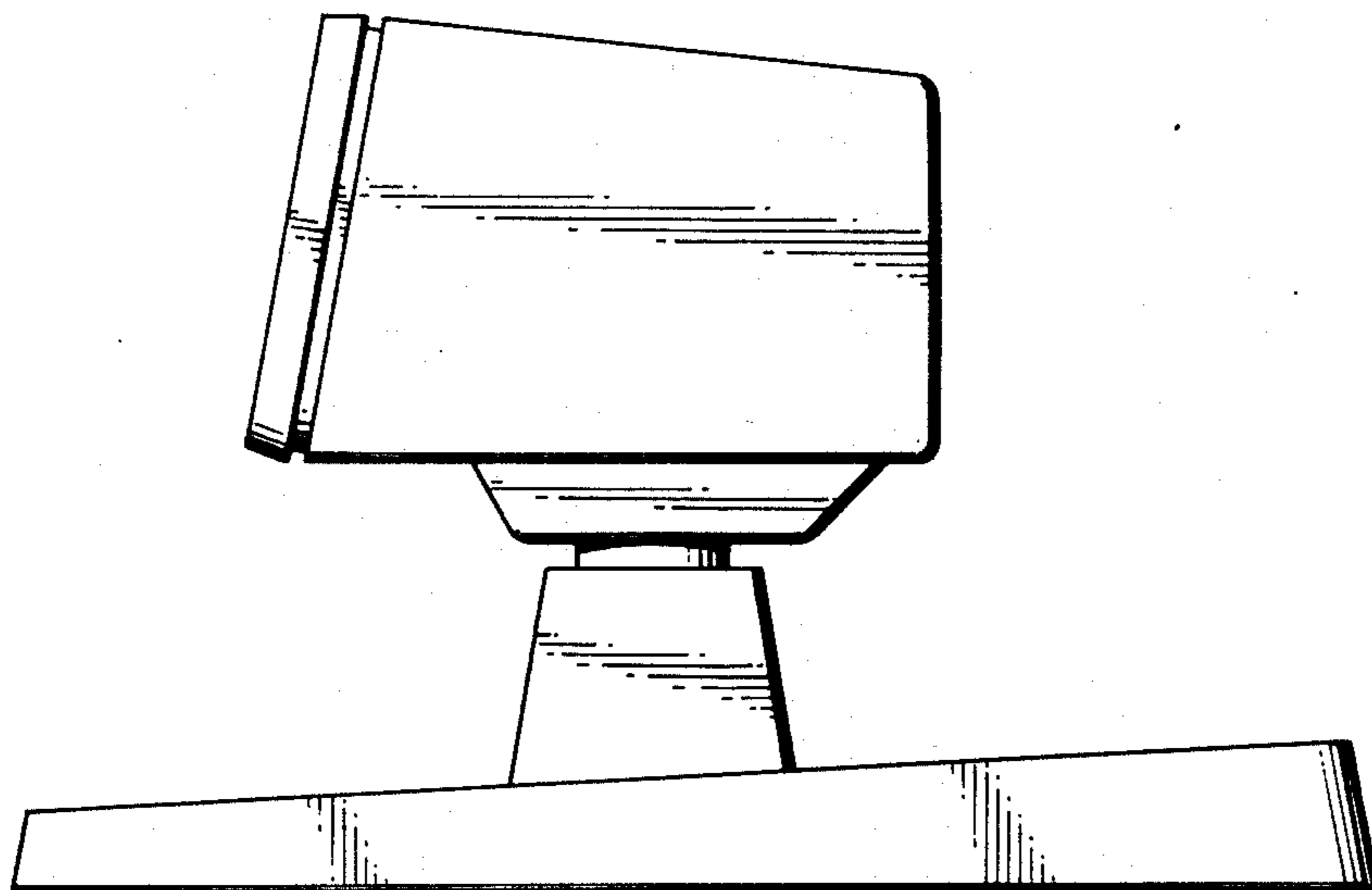
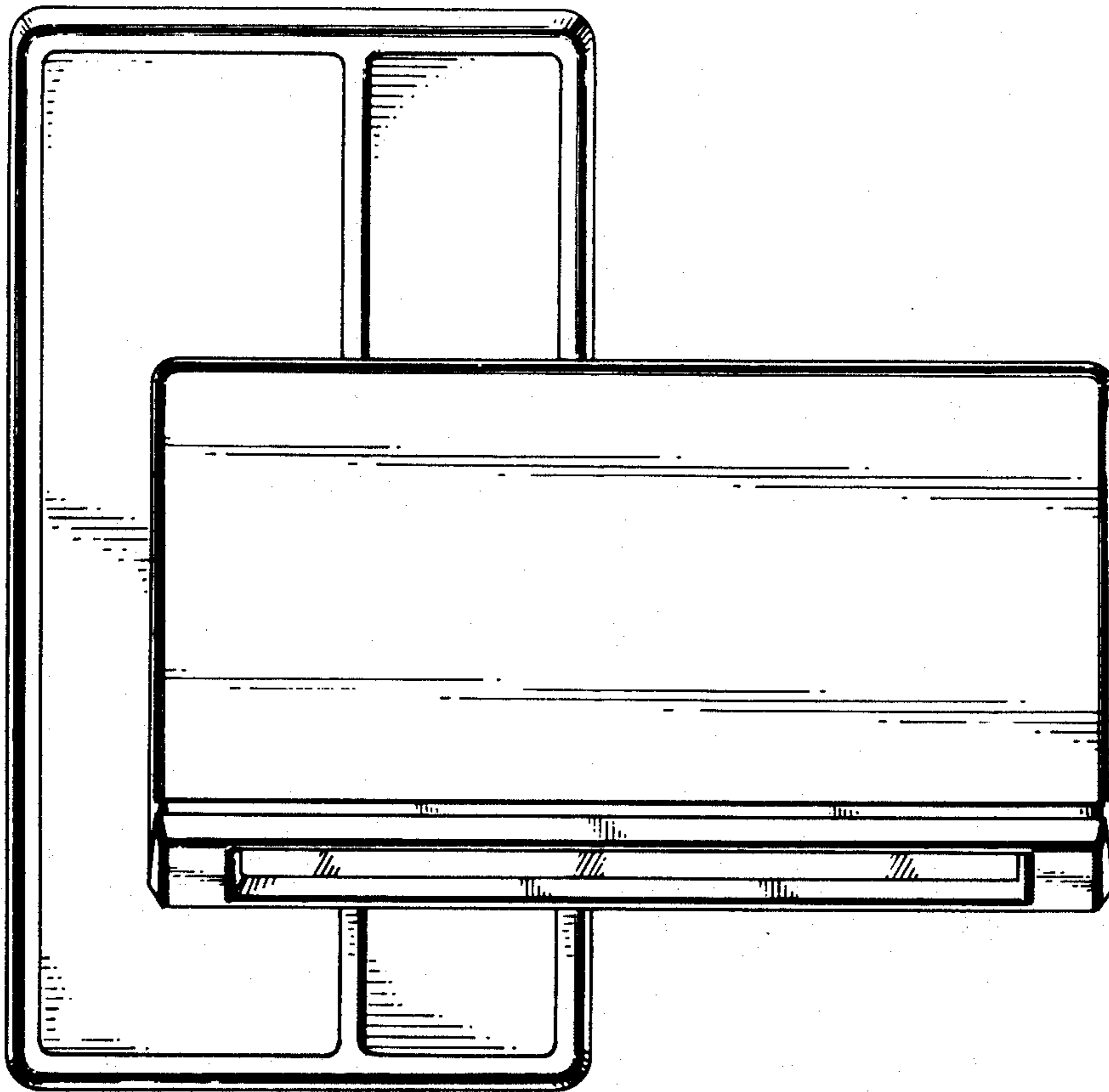

Fig.5



**Fig.6**



**Fig.7**

