

[54] TELEPHONE STAND

DESCRIPTION

[75] Inventors: Donald M. Genaro, Haworth, N.J.; John N. McGarvey, Drexel Hill, Pa.; Gordon E. Sylvester, Jamaica, N.Y.

[73] Assignee: Bell Telephone Laboratories, Incorporated, Murray Hill, N.J.

[**] Term: 14 Years

[21] Appl. No.: 854,160

[22] Filed: Nov. 23, 1977

Related U.S. Application Data

[60] Division of Ser. No. 604,592, Aug. 14, 1975, which is a continuation-in-part of Ser. No. 469,855, May 14, 1974, Pat. No. Des. 237,506, which is a continuation-in-part of Ser. No. 424,413, Dec. 13, 1973, abandoned, which is a continuation-in-part of Ser. No. 364,704, May 29, 1973, abandoned.

[51] Int. Cl. D14-03

[52] U.S. Cl. D14/60

[58] Field of Search 179/178, 179, 100 D, 179/100 R, 100 C, 184 D; D14/60, 57, 53

[56] References Cited

U.S. PATENT DOCUMENTS

D. 203,750	2/1966	Wharton	D14/62
D. 211,739	7/1968	Dreyfus	D14/62
D. 224,409	7/1972	Janda	D14/58
D. 231,650	5/1974	Eubank et al.	D14/60
D. 237,506	11/1975	Genaro et al.	D14/60
3,941,951	3/1976	Engstrom	179/100 C

Primary Examiner—Bernard Ansher
Attorney, Agent, or Firm—W. L. Keefauver

[57] CLAIM

The ornamental design for a telephone stand, substantially as shown and described.

FIG. 1 is a side elevation of a telephone stand showing our new design;
 FIG. 2 is a top view taken perpendicular to the face of the telephone stand;
 FIG. 3 is a front elevation thereof;
 FIG. 4 is a rear elevation thereof;
 FIG. 5 is a side elevation of a second embodiment of the telephone stand illustrated in FIGS. 1 through 4, the front view taken perpendicular to the face of this embodiment being essentially the same as shown in FIG. 2;
 FIG. 6 is a top elevation thereof;
 FIG. 7 is a bottom elevation thereof;
 FIG. 8 is a side elevation of a third embodiment of the telephone stand illustrated in FIGS. 1 through 4;
 FIG. 9 is a top view taken perpendicular to the face of the telephone stand;
 FIG. 10 is a front elevation thereof;
 FIG. 11 is a rear elevation thereof;
 FIG. 12 is a side elevation of a fourth embodiment of the telephone stand illustrated in FIGS. 1 through 4, the front view taken perpendicular to the face of this embodiment being essentially the same as shown in FIG. 9;
 FIG. 13 is a top elevation thereof;
 FIG. 14 is a bottom elevation thereof;
 FIG. 15 is a side elevation of a fifth embodiment of the telephone stand illustrated in FIGS. 1 through 4;
 FIG. 16 is a top view taken perpendicular to the face of the telephone stand;
 FIG. 17 is a rear elevation thereof;
 FIG. 18 is a front elevation thereof;
 FIG. 19 is a side elevation of a sixth embodiment of the telephone stand illustrated in FIGS. 1 through 4, the front view taken perpendicular to the face of this embodiment being essentially the same as shown in FIG. 16;
 FIG. 20 is a bottom elevation thereof;
 FIG. 21 is a top elevation thereof;
 FIG. 22 is a perspective view of the telephone stand shown in FIGS. 1 through 4;
 FIG. 23 is a perspective view of the telephone stand shown in FIGS. 8 through 11; and
 FIG. 24 is a perspective view of the telephone stand shown in FIGS. 15 through 18.

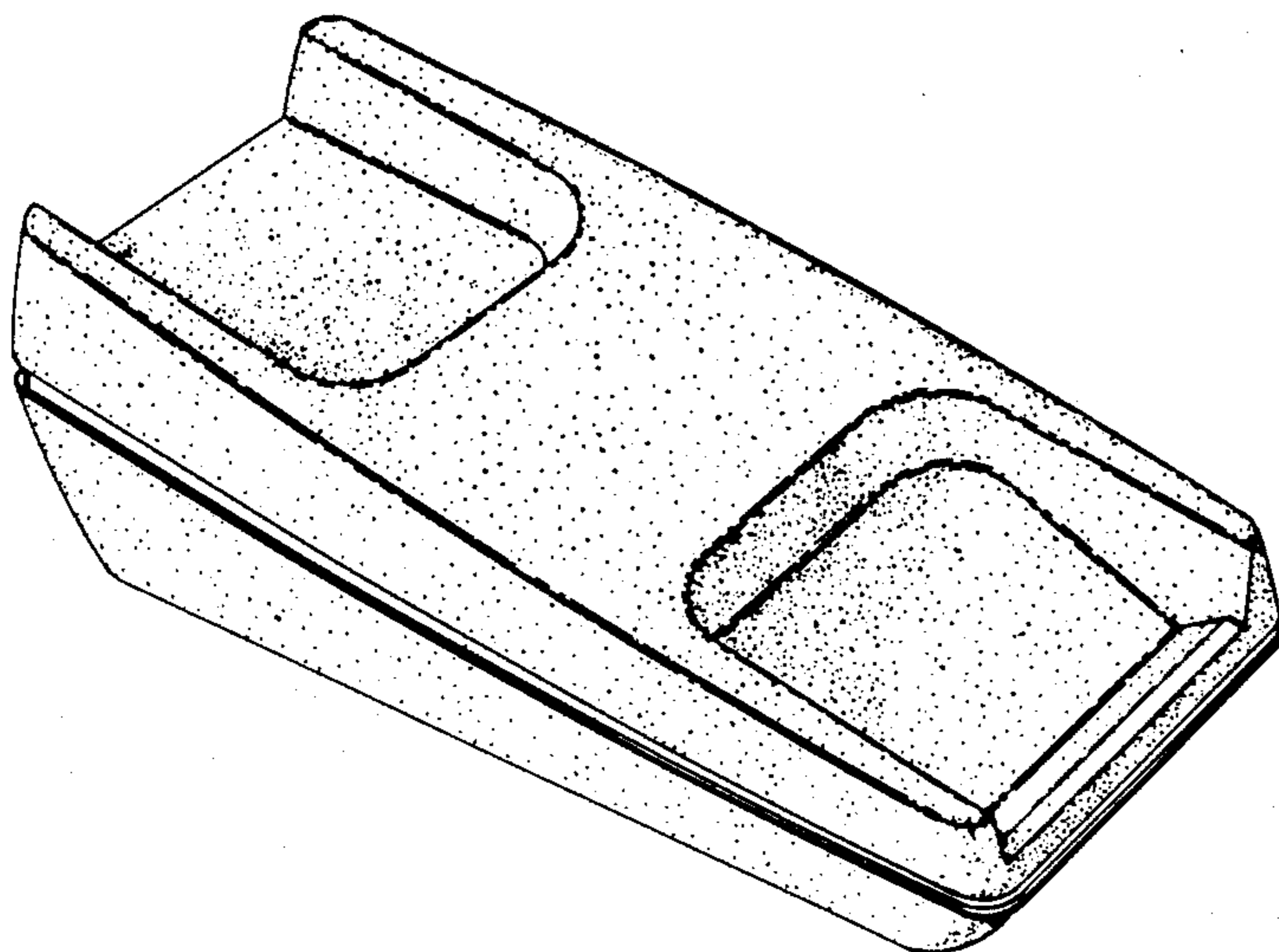

FIG. 1

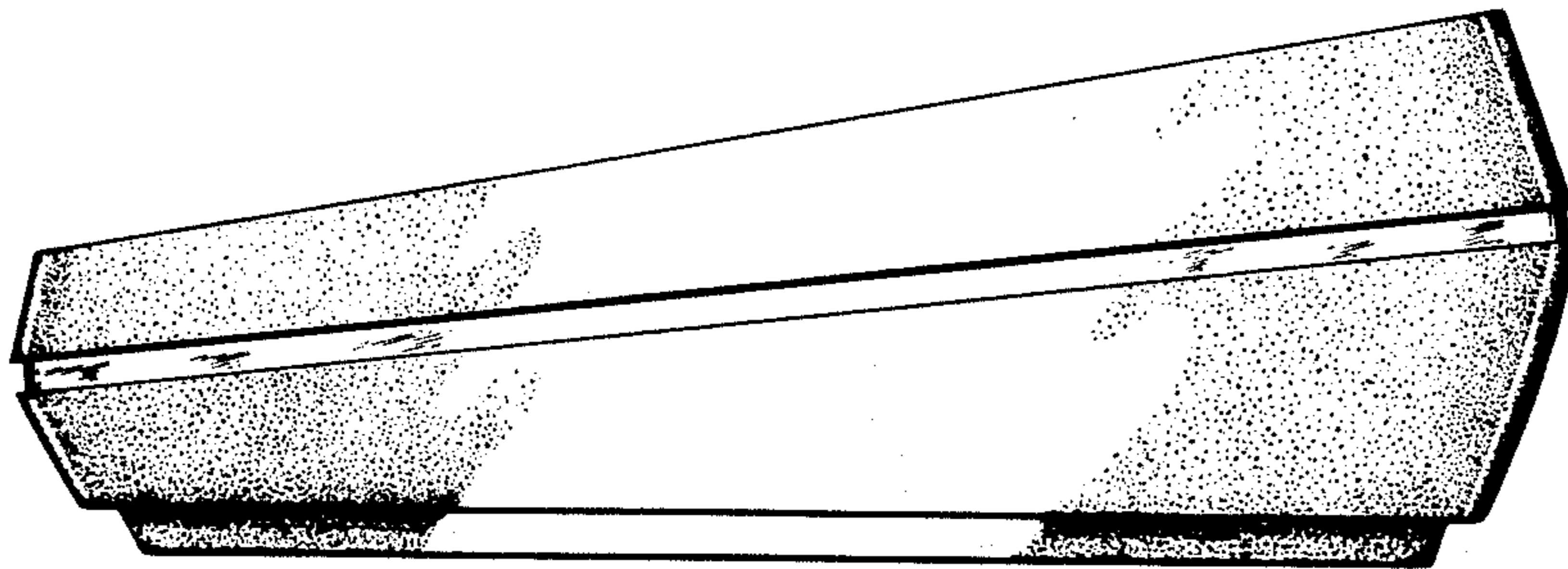

FIG. 2

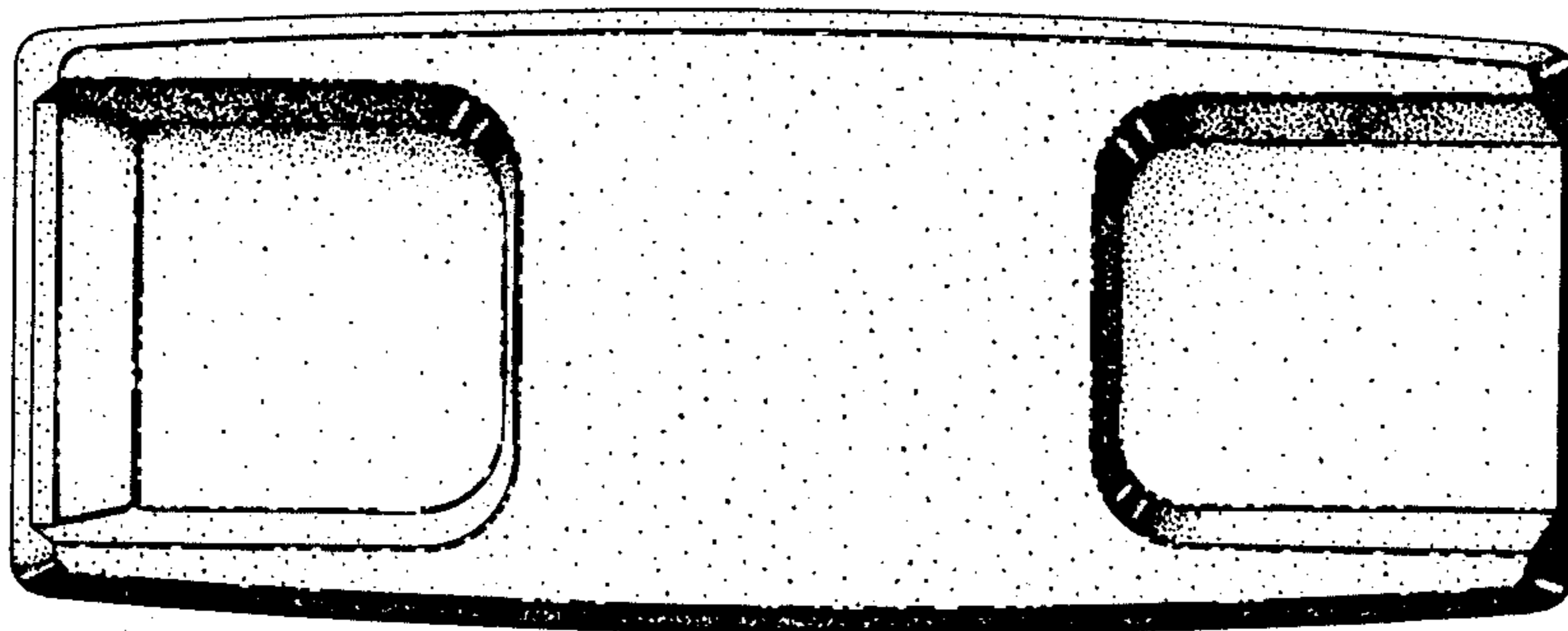

FIG. 3

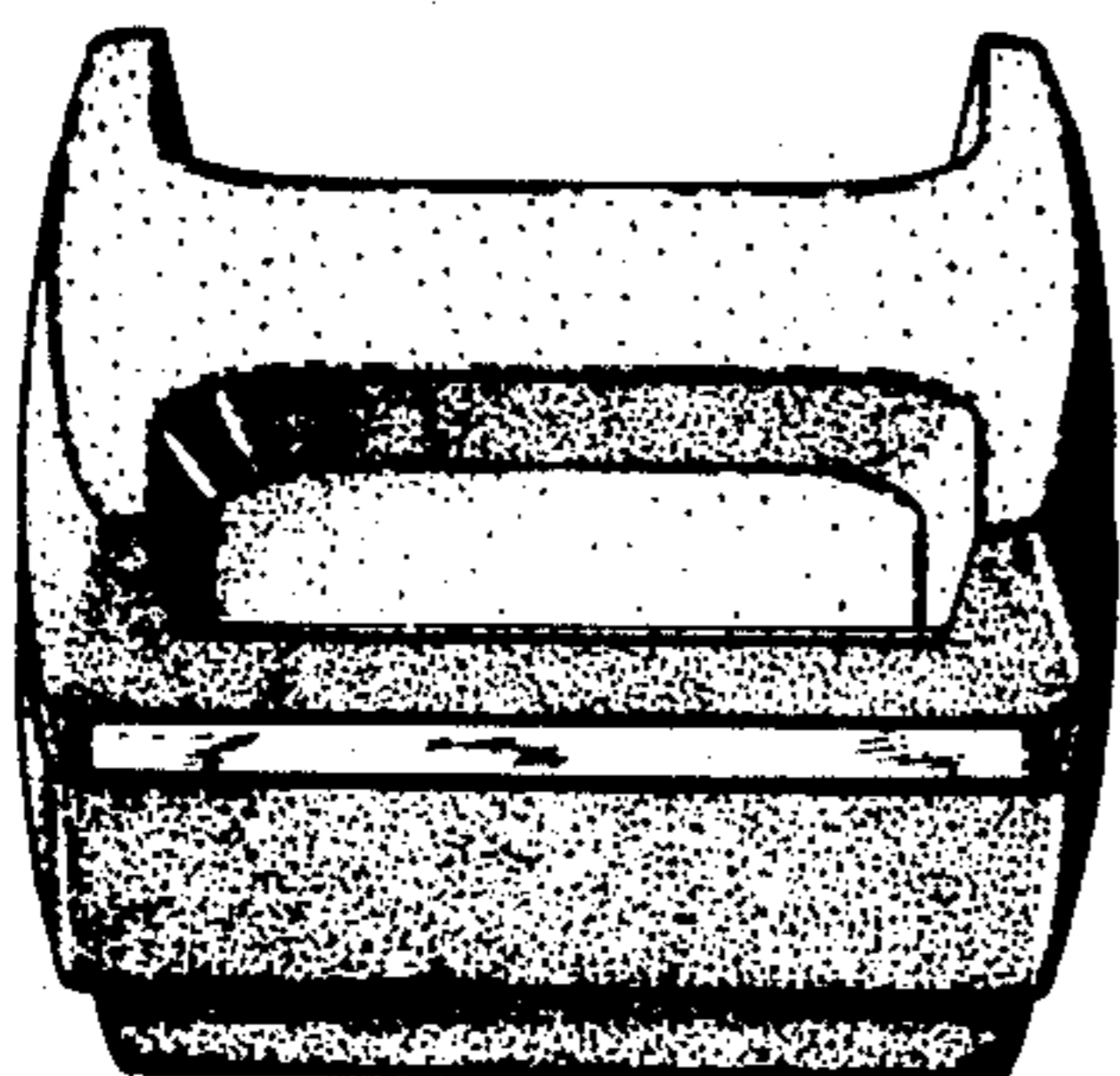

FIG. 4

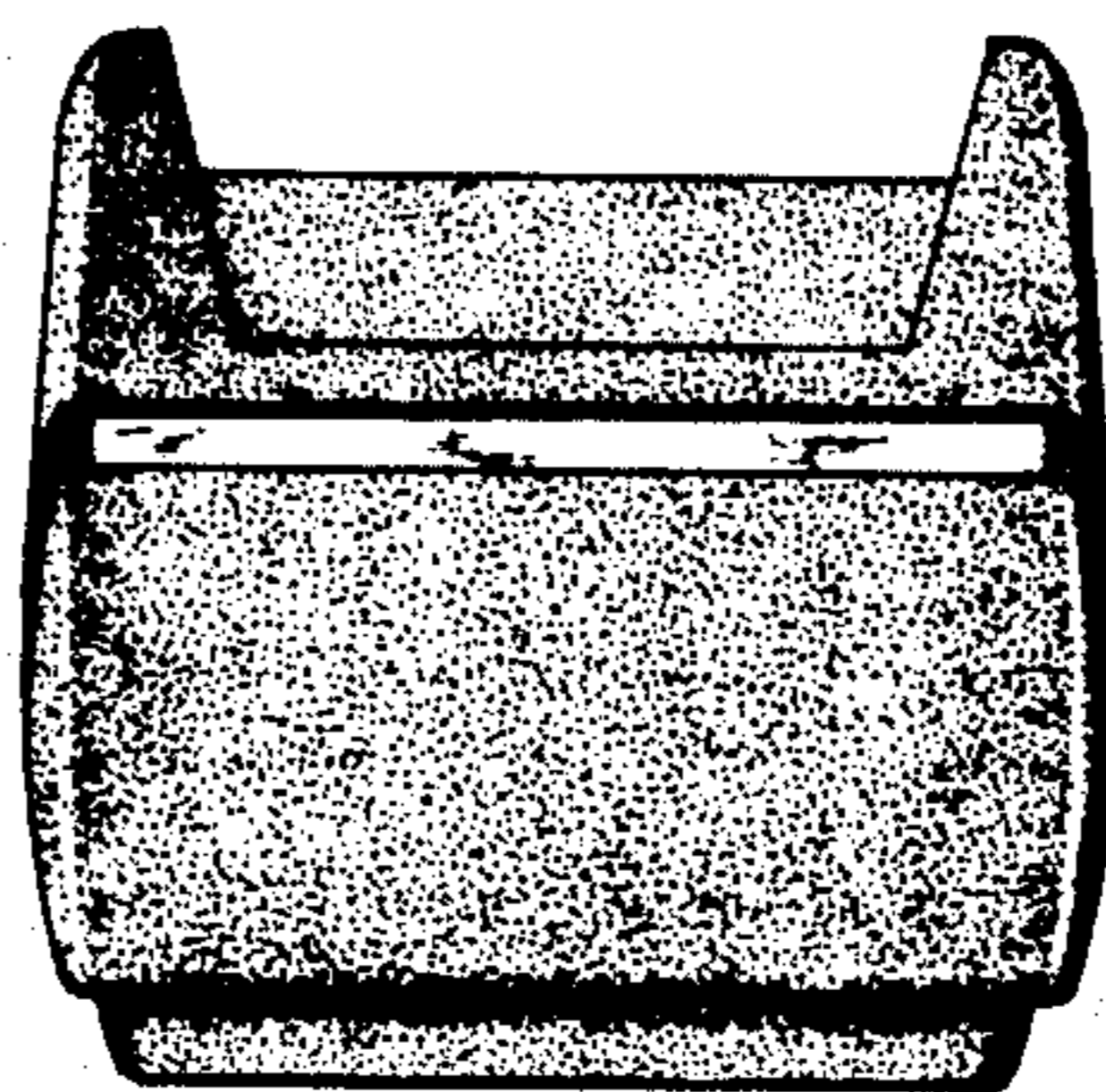

FIG. 5

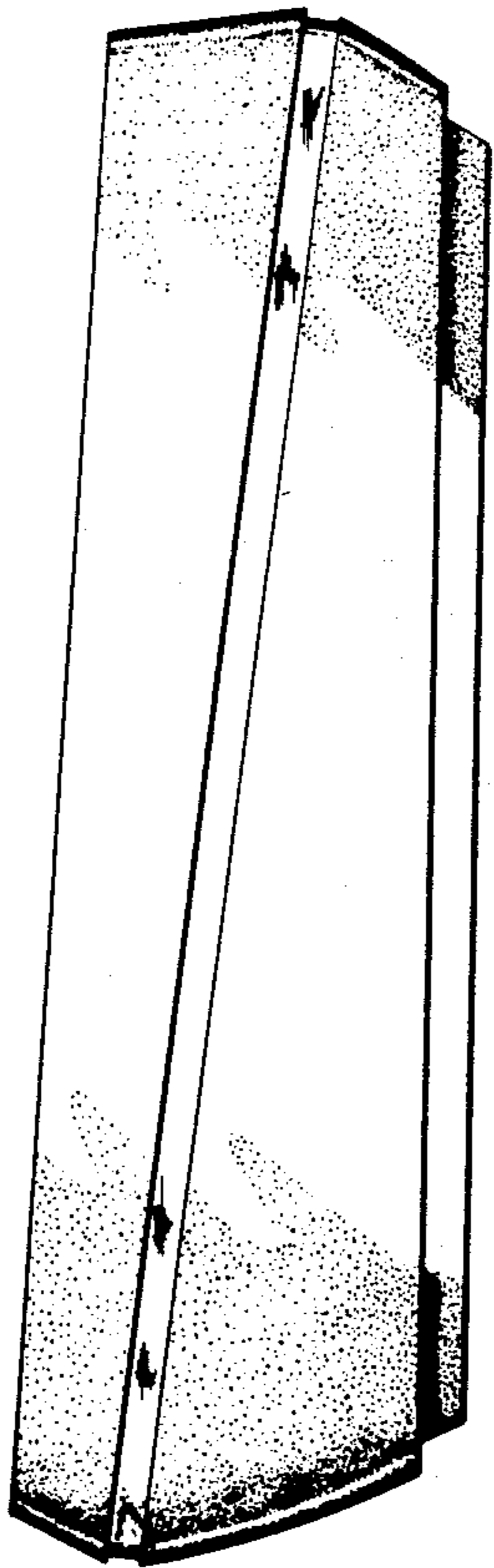

FIG. 6

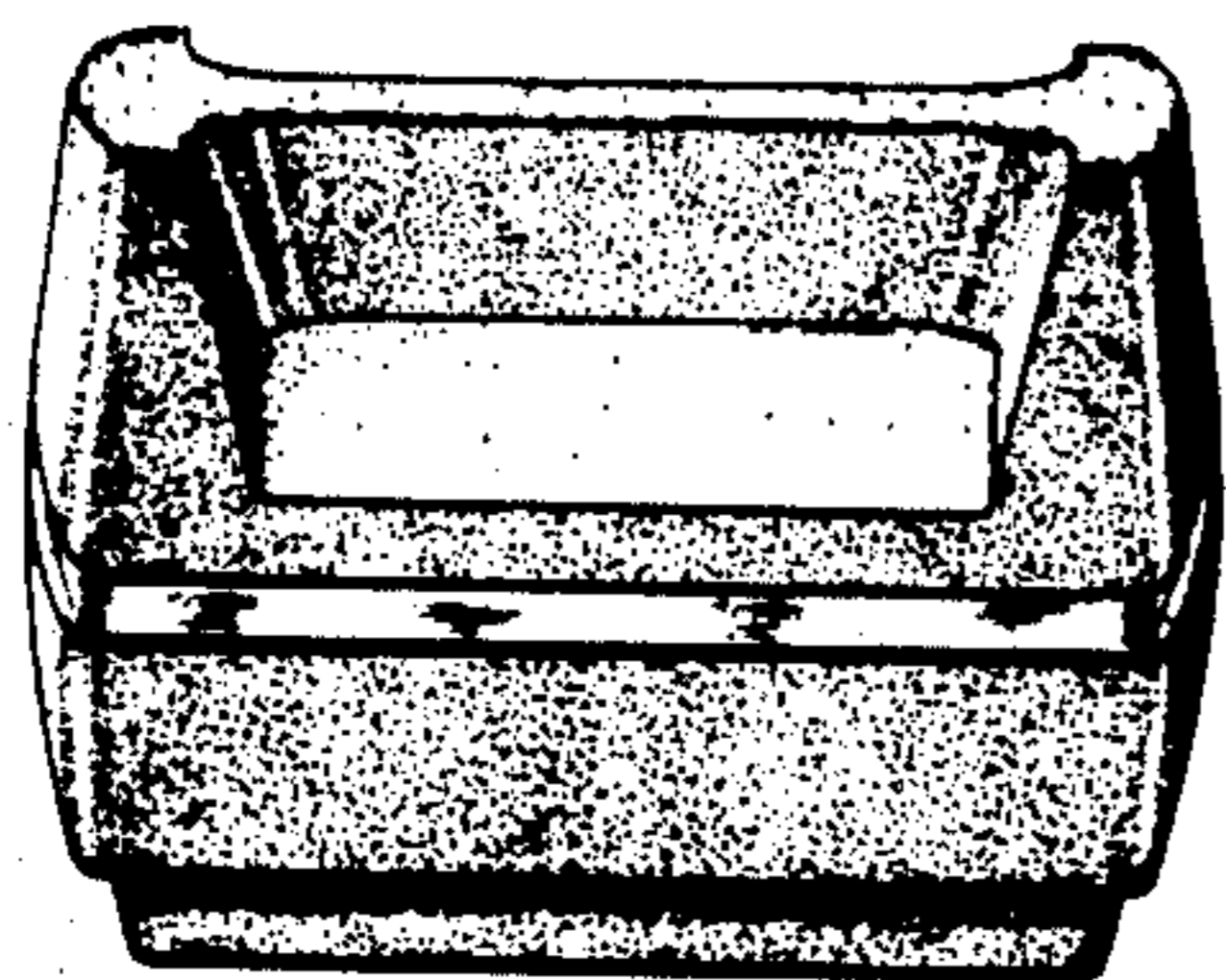

FIG. 7

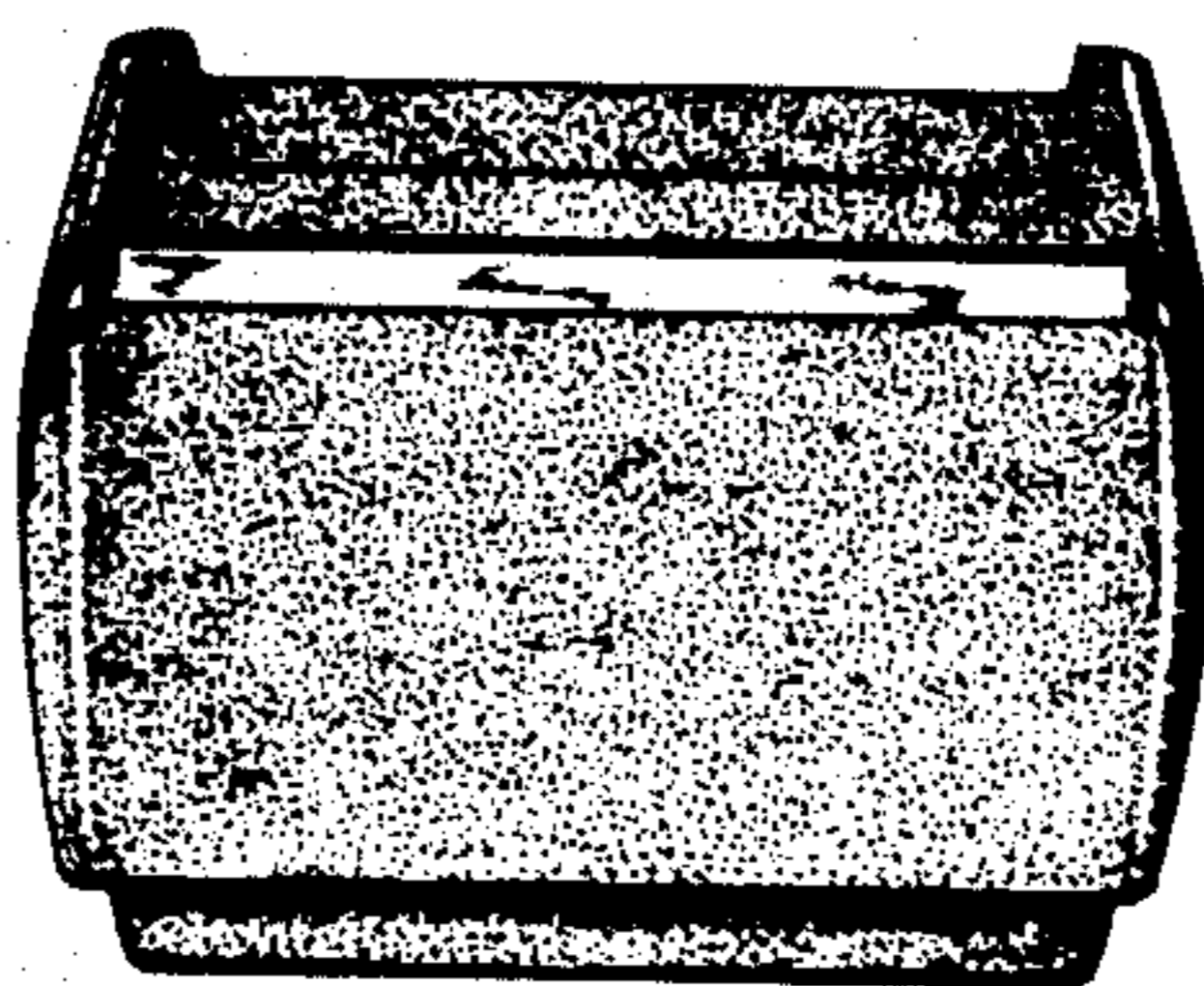

FIG. 8

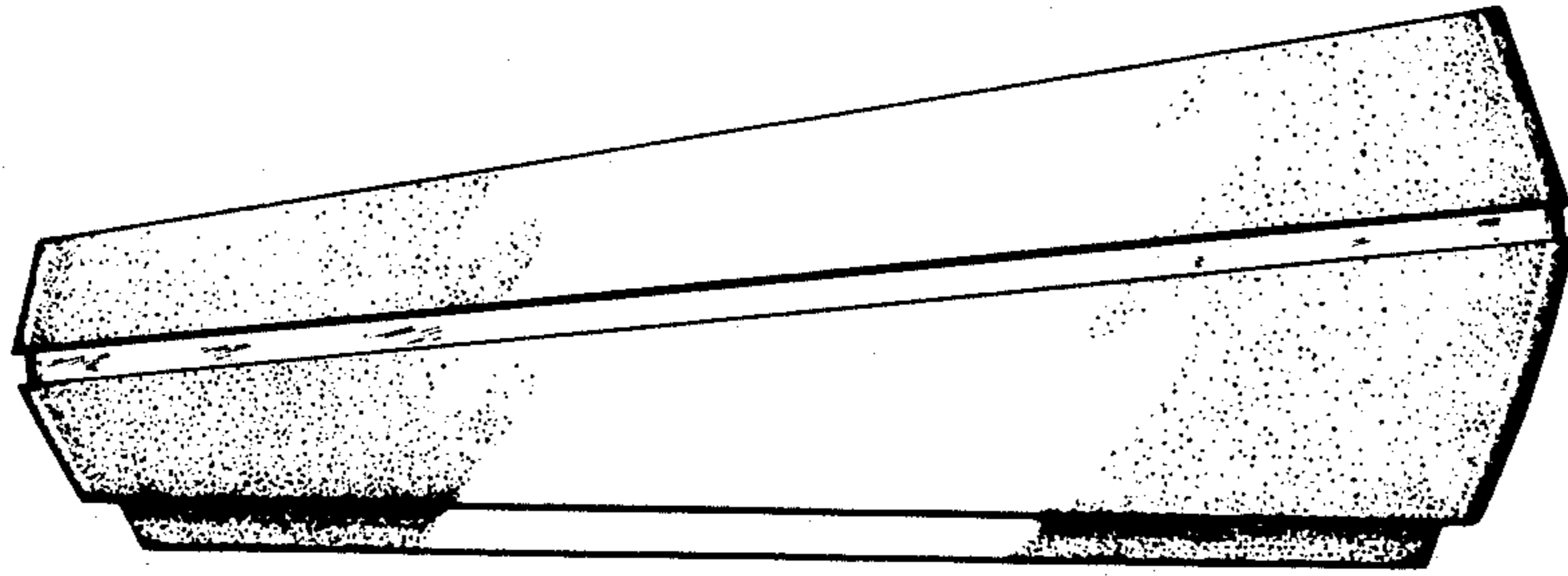

FIG. 9



FIG. 10

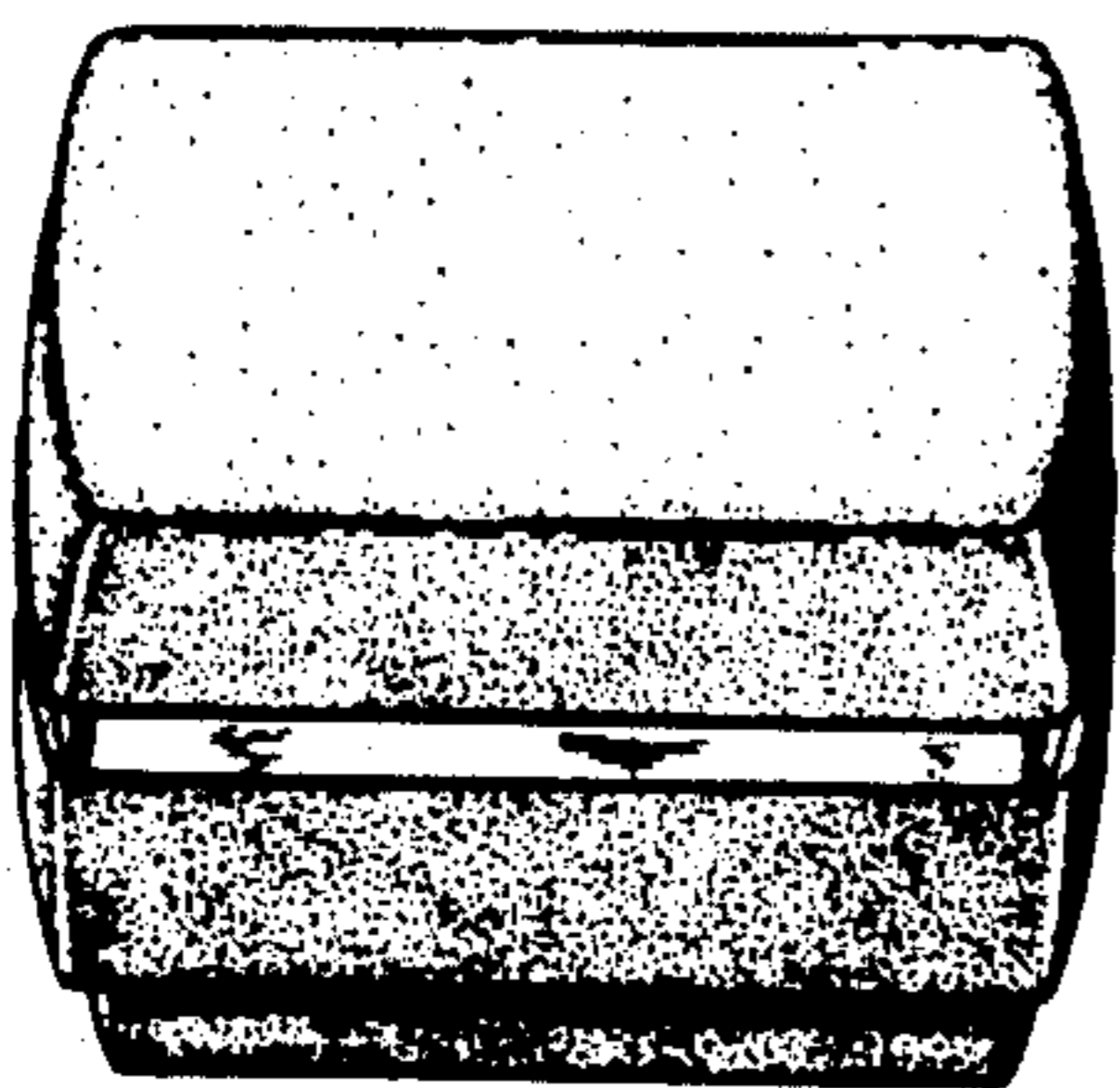

FIG. 11

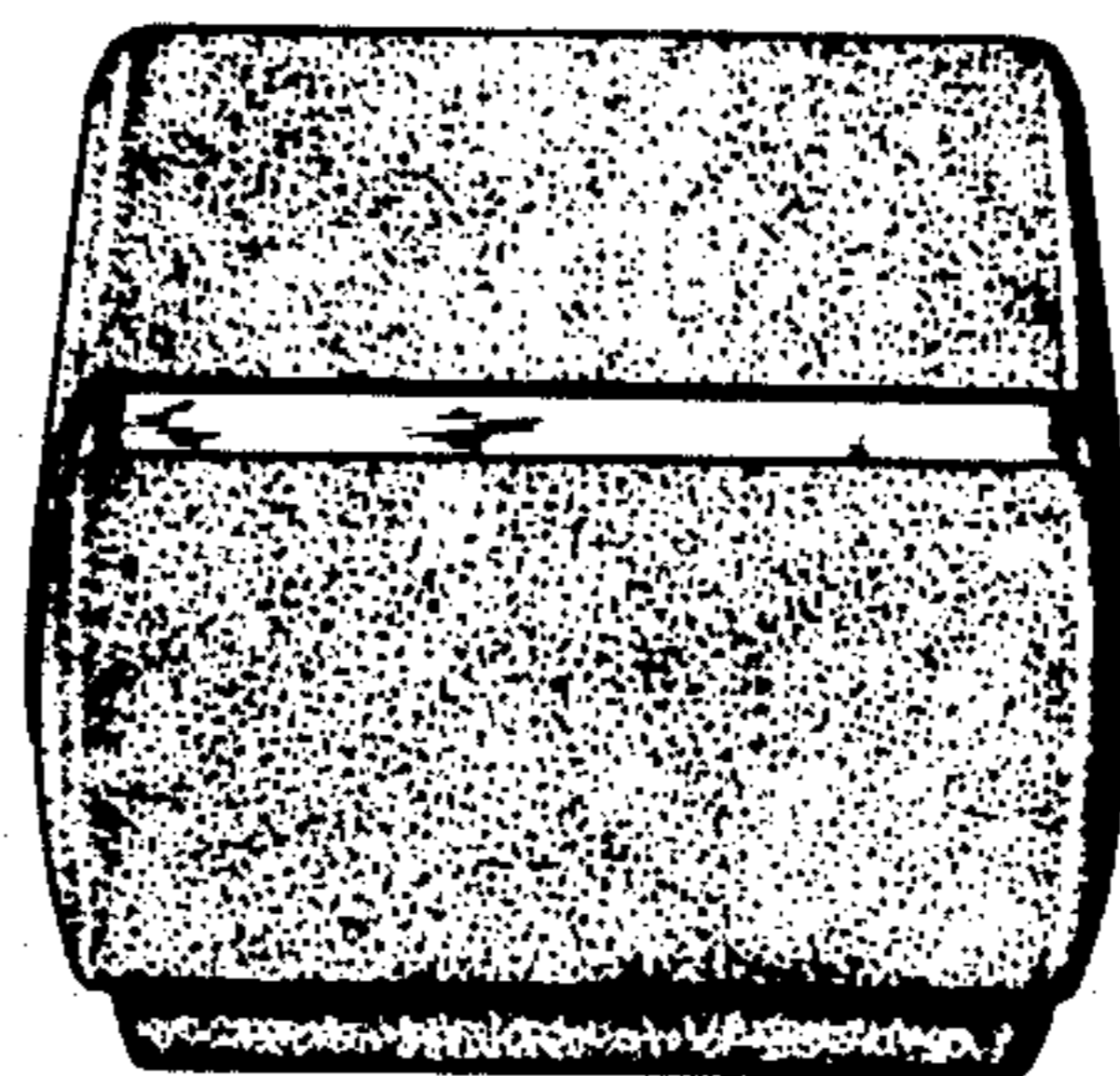

FIG. 12

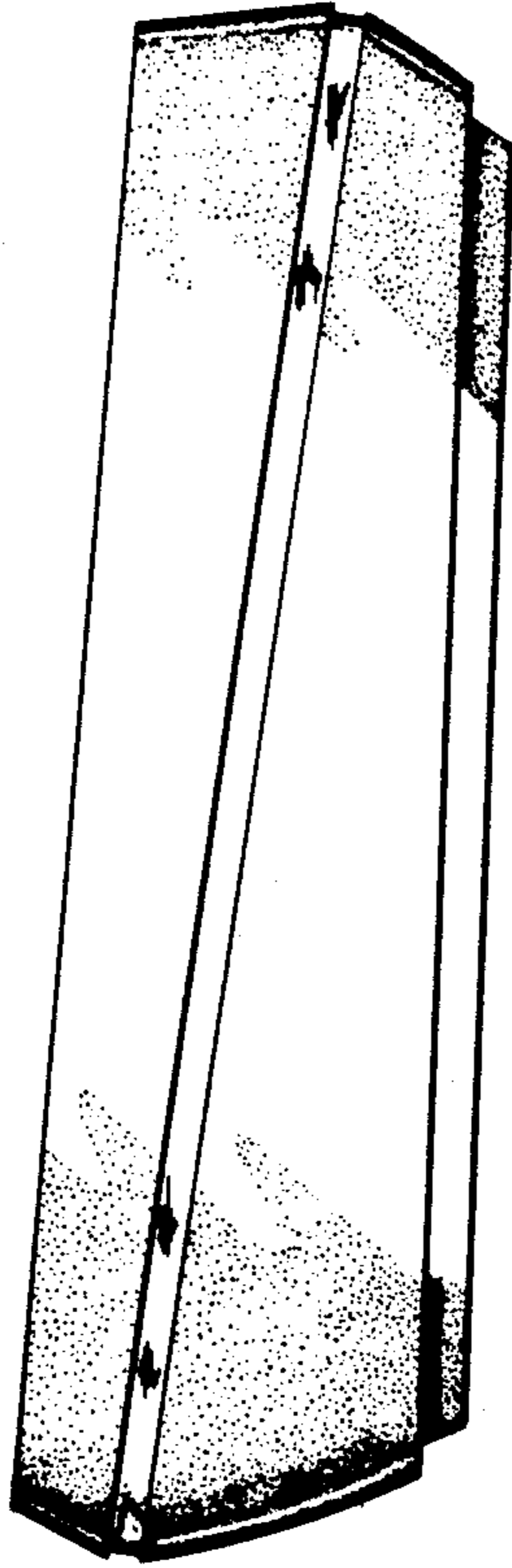

FIG. 13

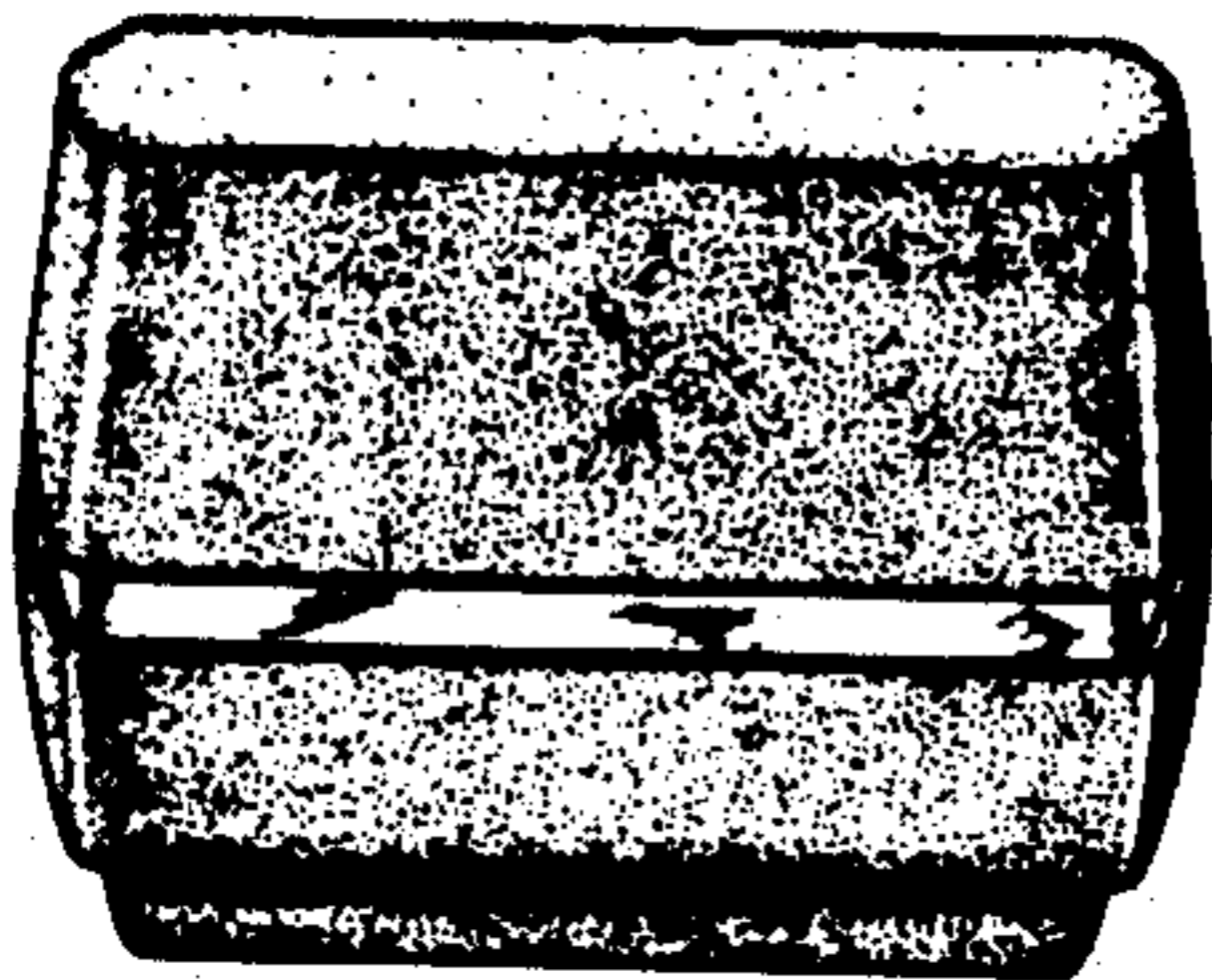

FIG. 14

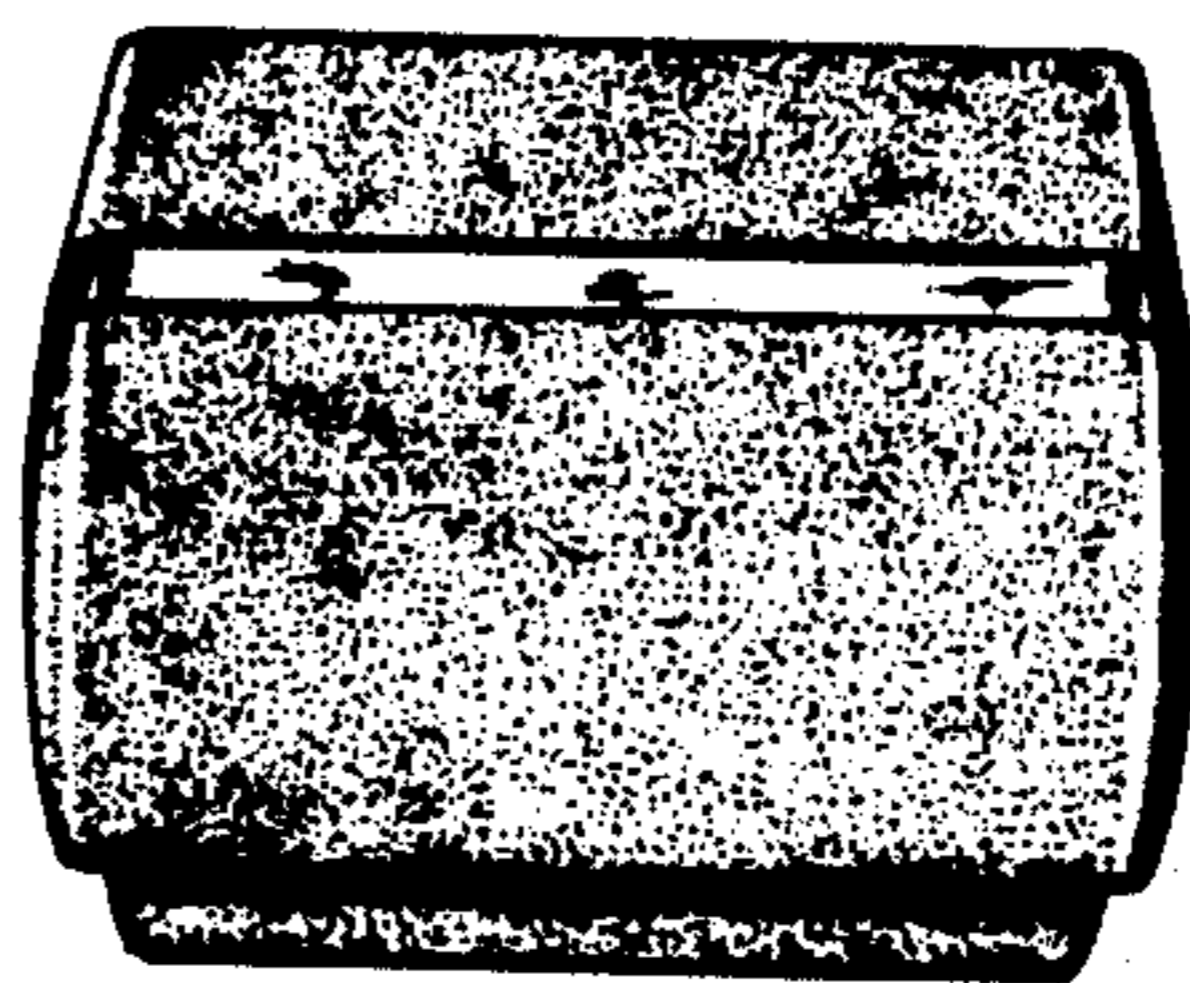

FIG. 15

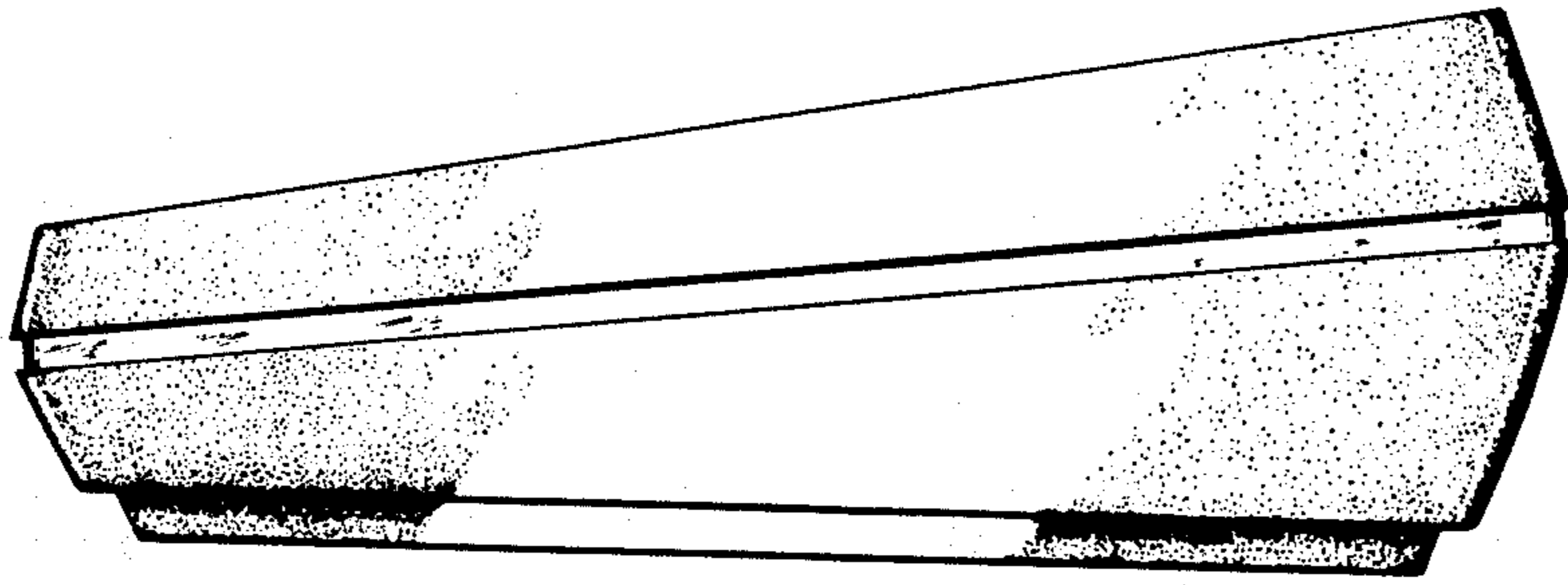

FIG. 16

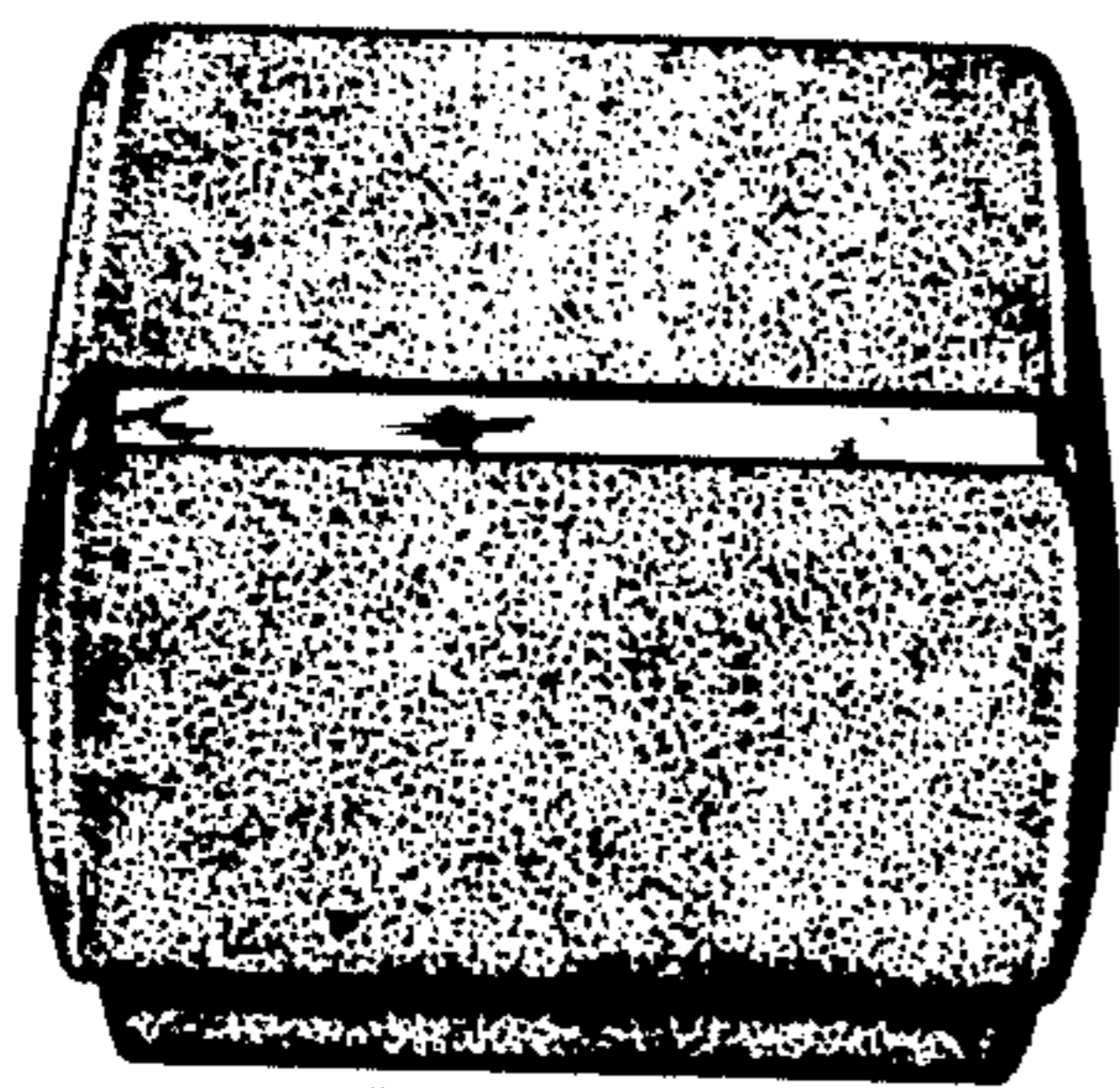

FIG. 17

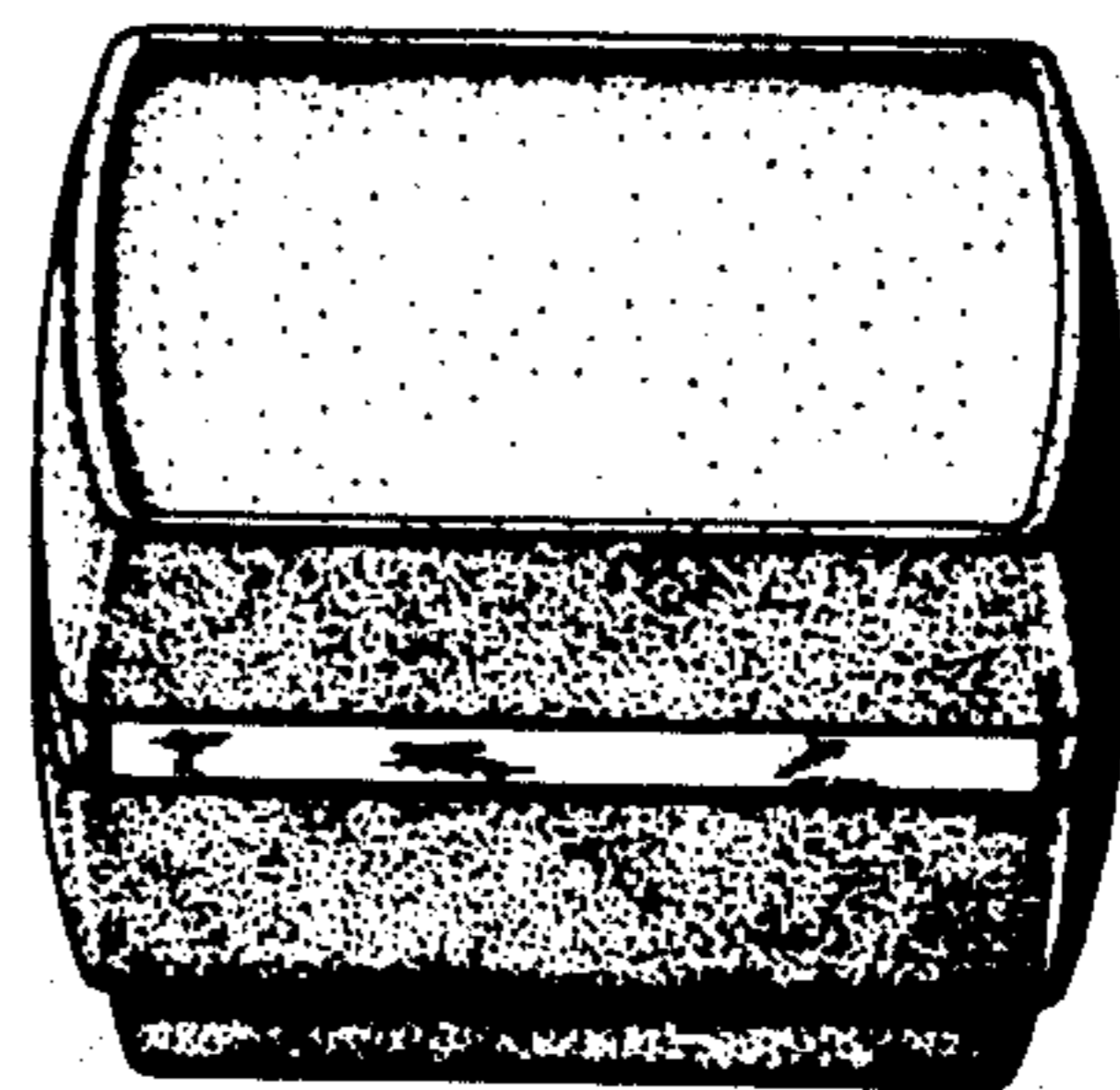

FIG. 18

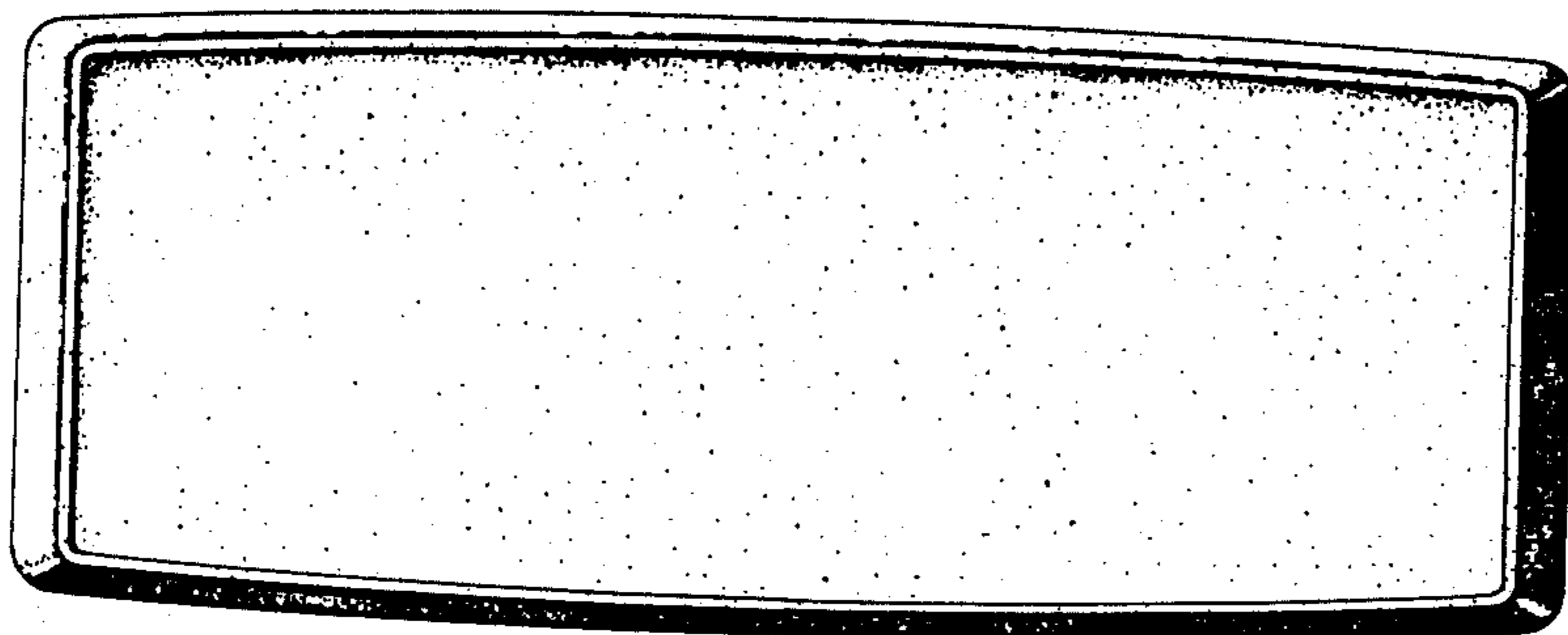

FIG. 19

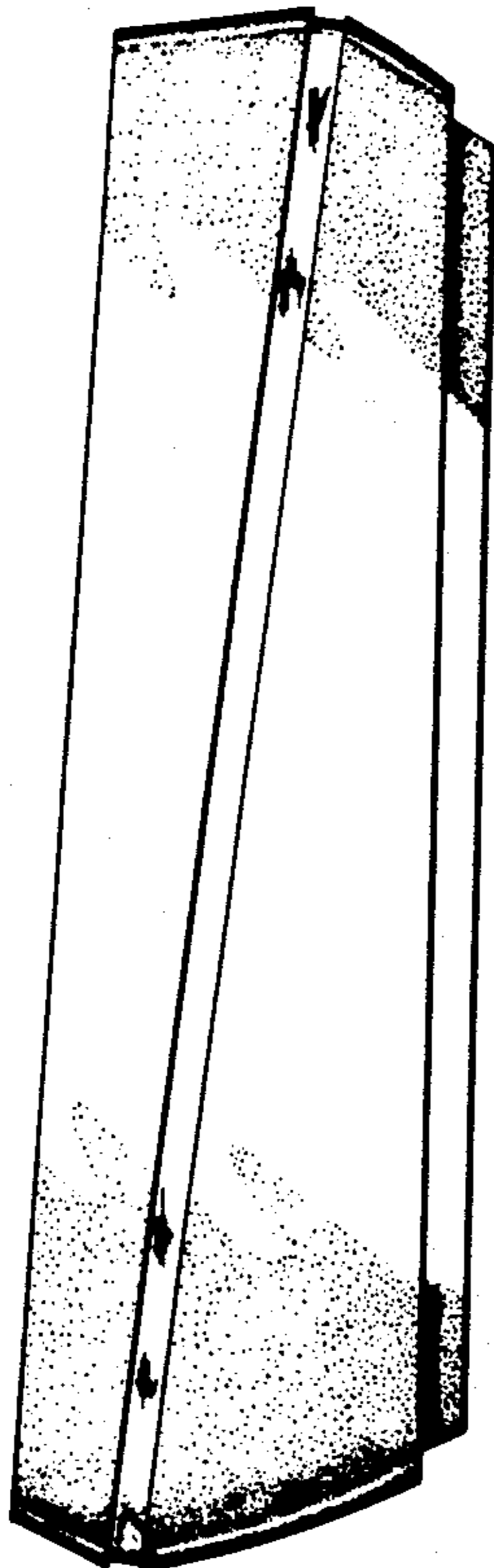

FIG. 20

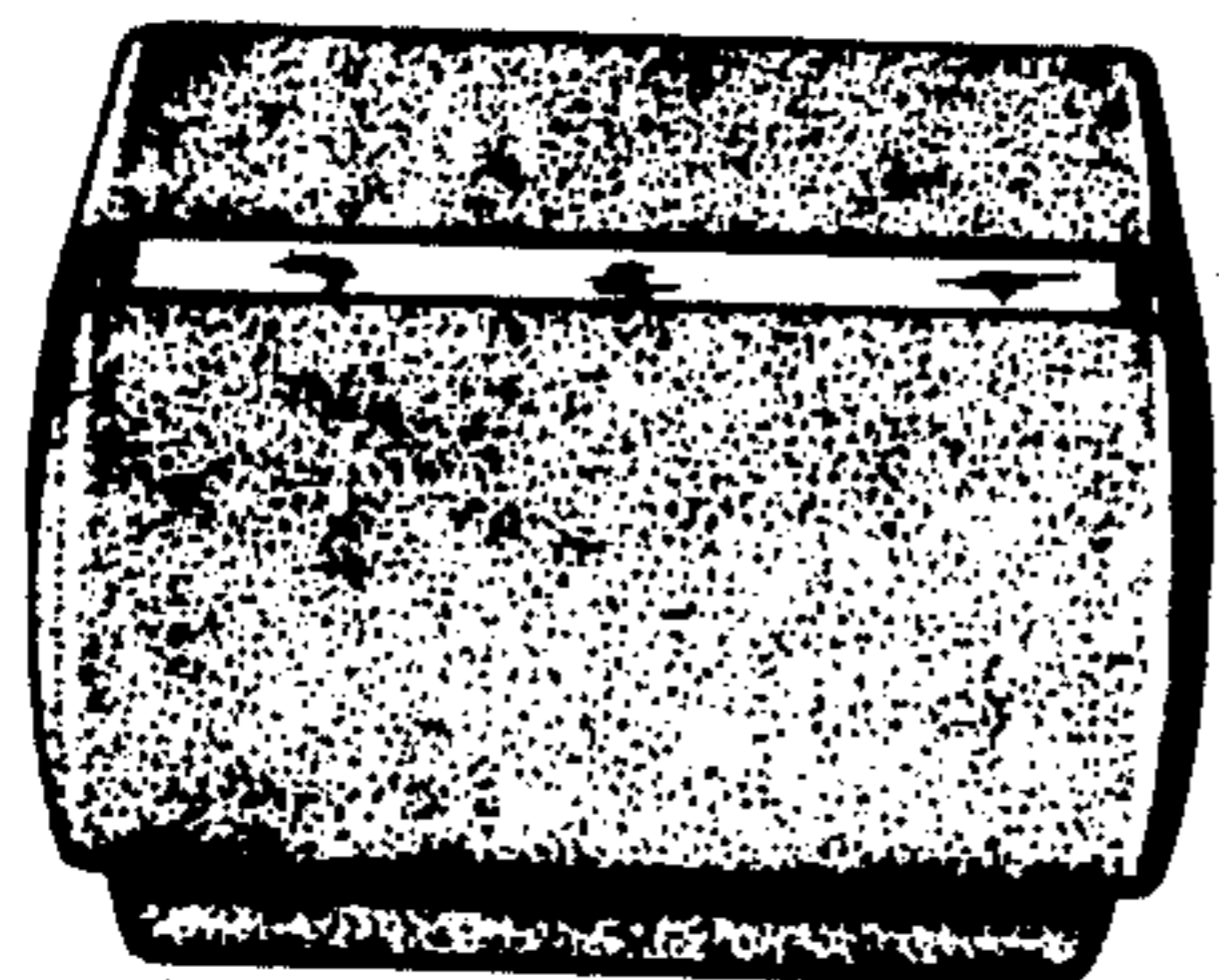

FIG. 21

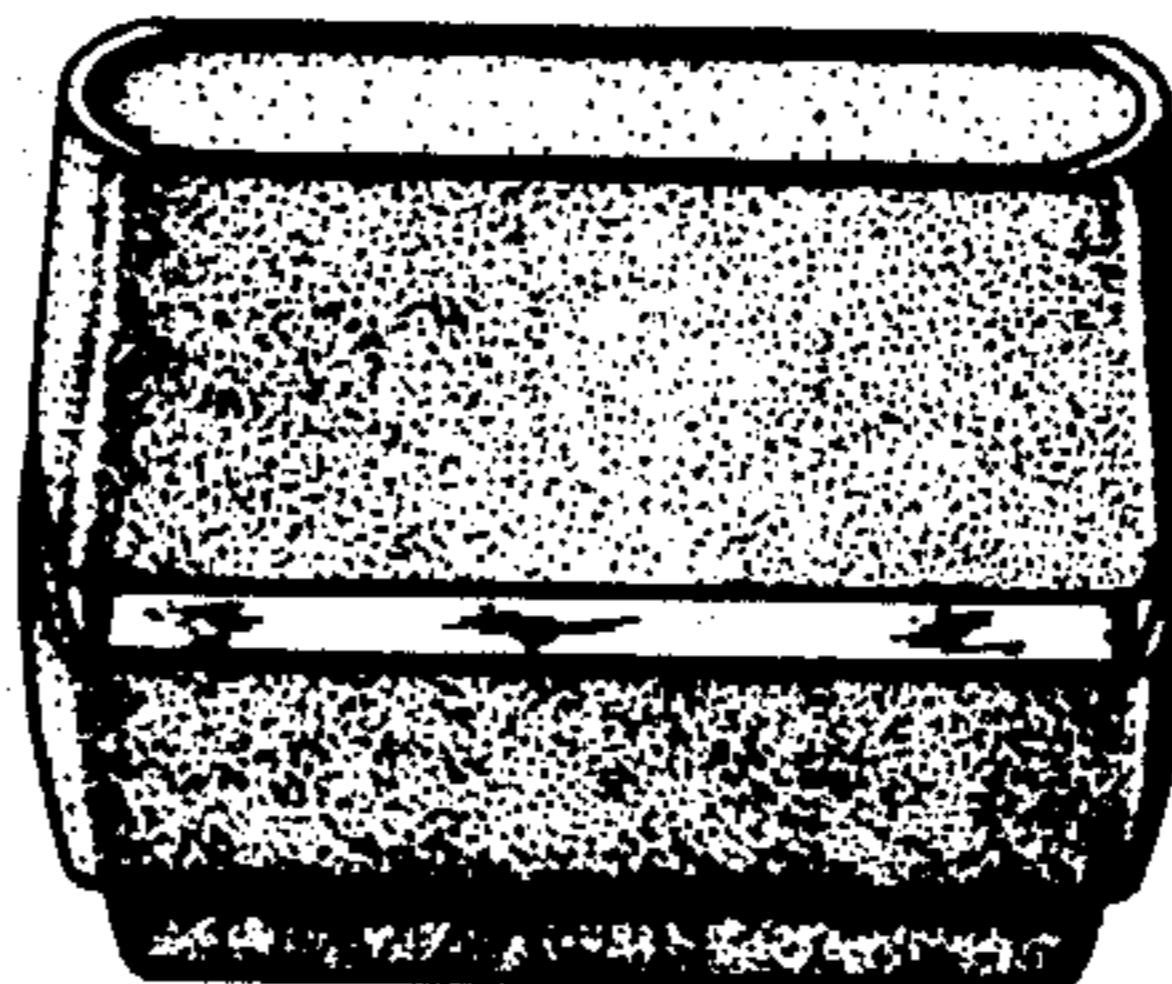

FIG. 22

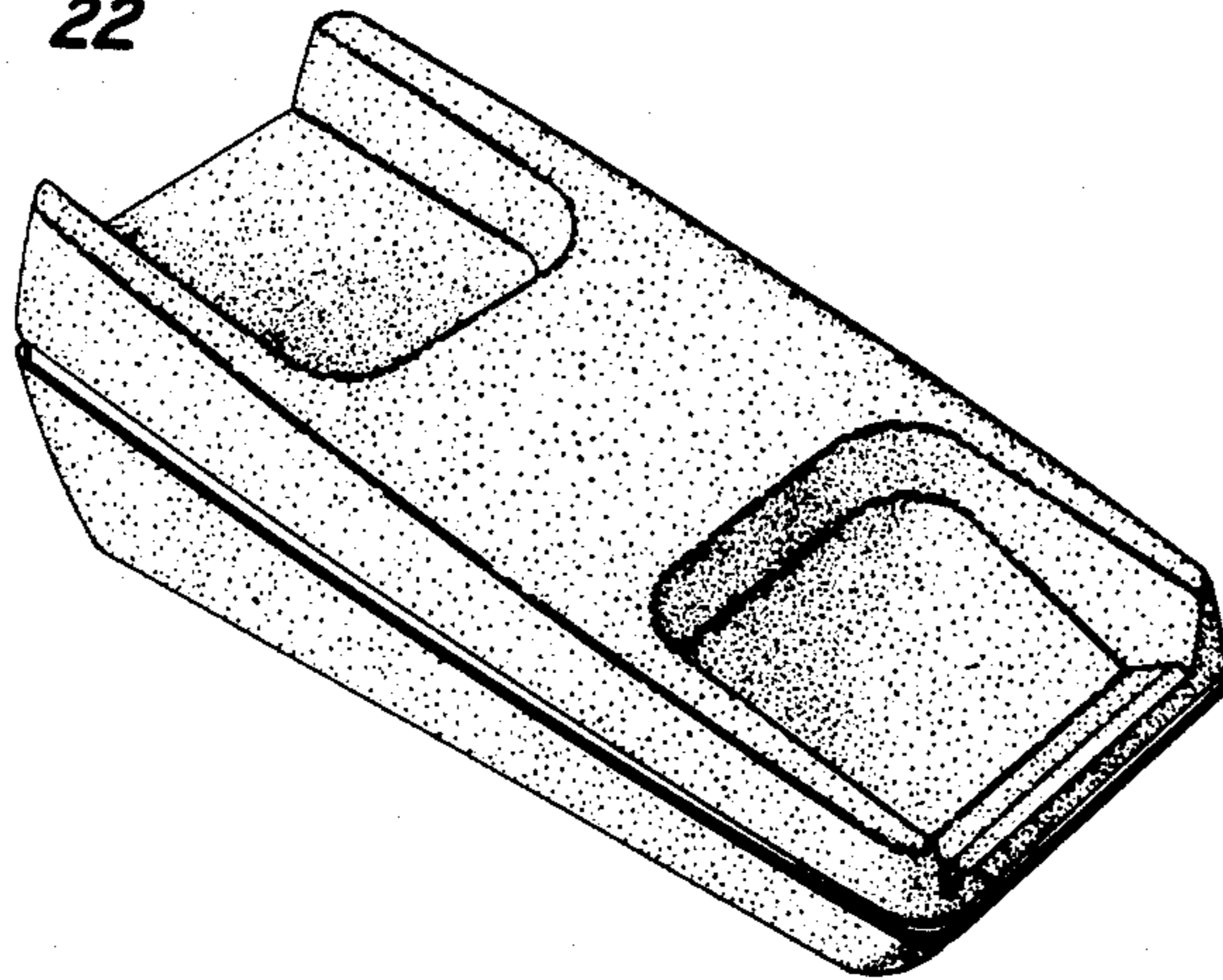

FIG. 23

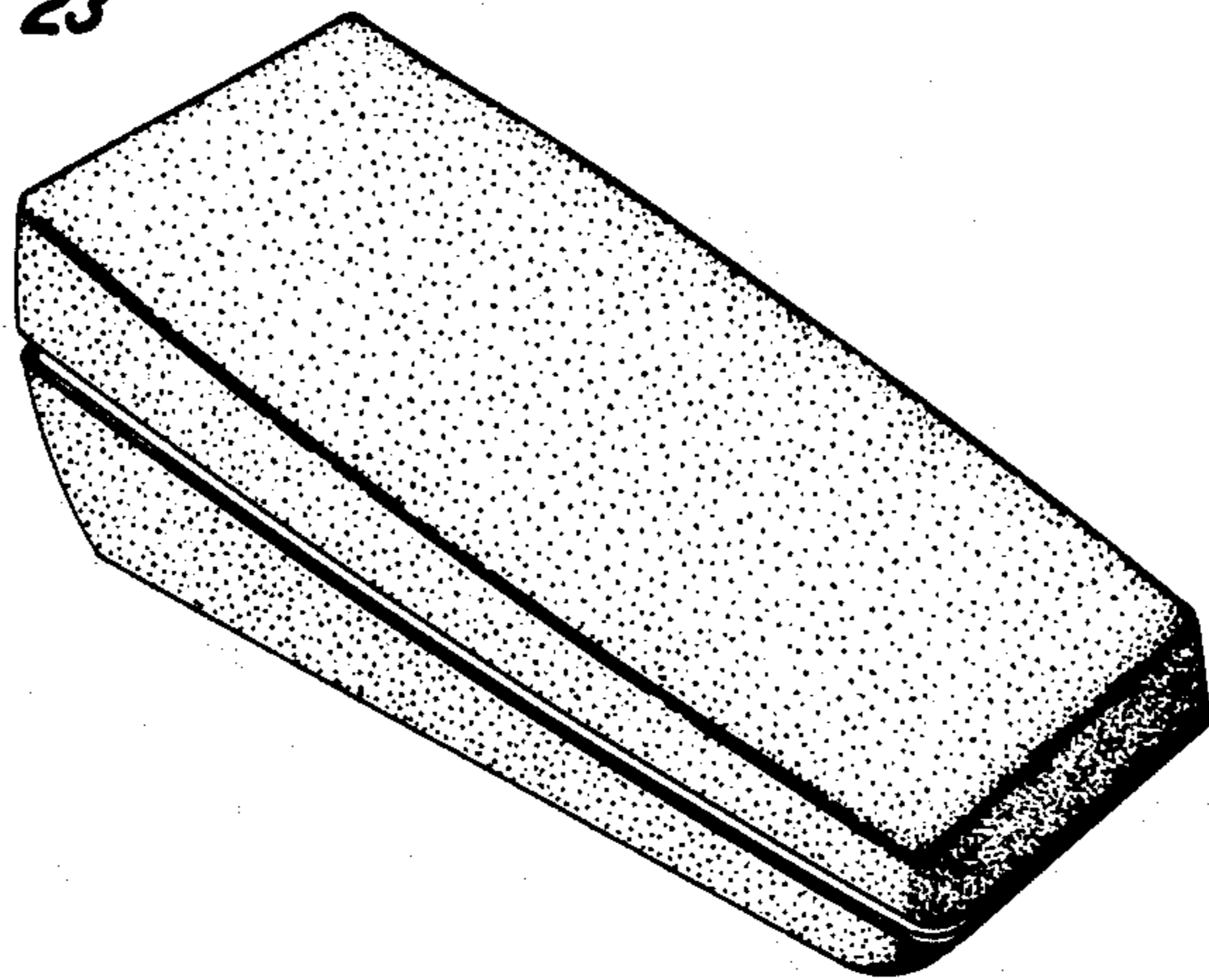
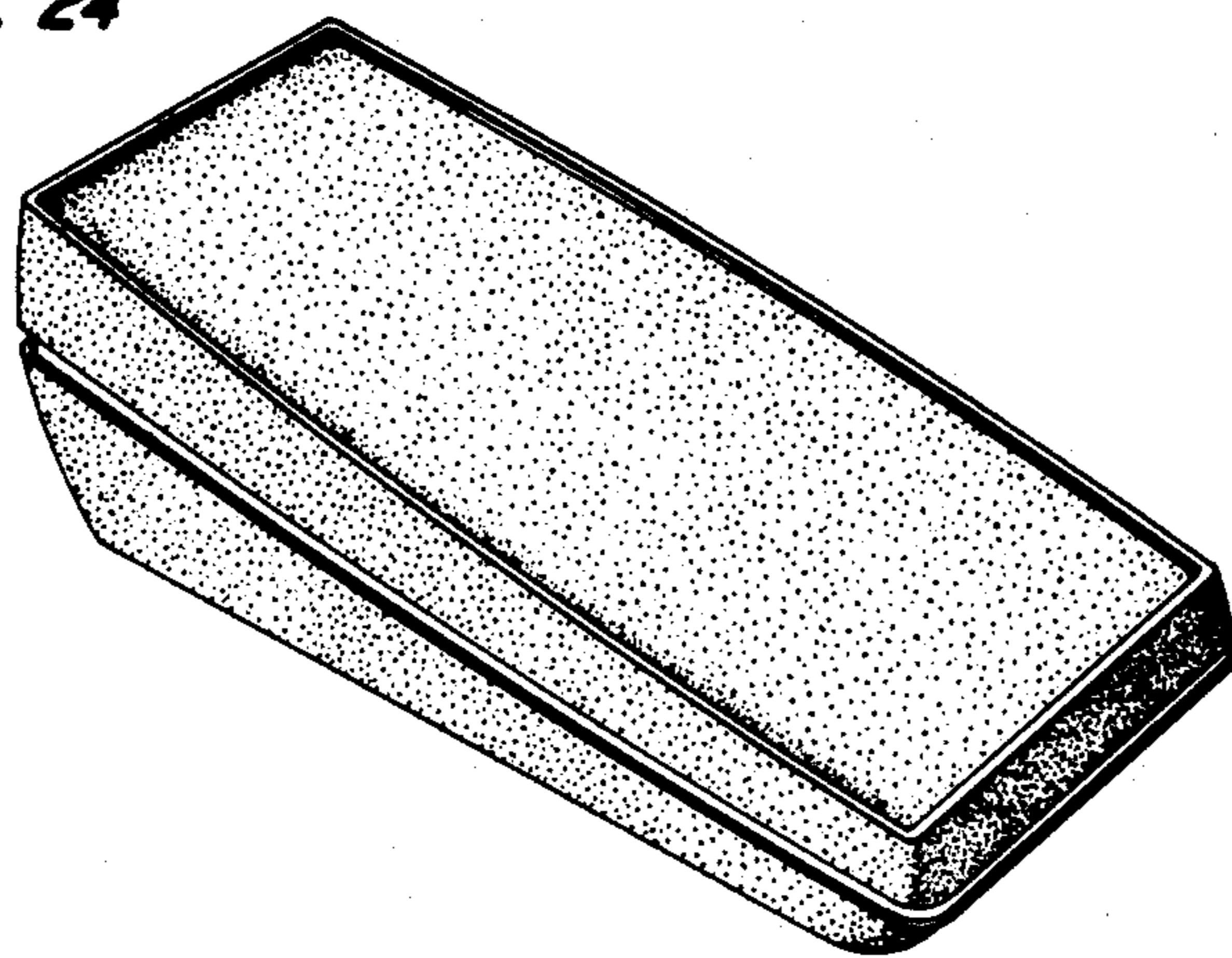

FIG. 24



UNITED STATES PATENT AND TRADEMARK OFFICE
CERTIFICATE OF CORRECTION

PATENT NO. : Des. No. 252,570
DATED : August 7, 1979
INVENTOR(S) : Donald Michael Genaro et al.

It is certified that error appears in the above—identified patent and that said Letters Patent is hereby corrected as shown below:

The term of this patent subsequent to
November 4, 1989, has been disclaimed.

Signed and Sealed this
Fifteenth **Day of** *January 1980*

[SEAL]

Attest:

Attesting Officer

SIDNEY A. DIAMOND

Commissioner of Patents and Trademarks