

[54] LIGHT FIXTURE

[76] Inventor: Fredrick R. Glassman, 9170 La Alba, Whittier, Calif. 90605

[**] Term: 14 Years

[21] Appl. No.: 802,987

[22] Filed: Jun. 2, 1977

[51] Int. Cl. D26-05

[52] U.S. Cl. D48/3

[58] Field of Search D48/23 R, 3; 362/351, 362/355, 356, 358, 404, 405, 806, 362, 363

[56] References Cited

U.S. PATENT DOCUMENTS

- D. 235,914 7/1975 Schacht D48/3
- D. 242,064 10/1976 Glassman D48/23 R

OTHER PUBLICATIONS

Architectural Record, 3-1968, p. 134. Hanging Lamp.

Architectural Record, 10-1975, p. 171, Lighting Fixture #909.

Primary Examiner—Susan J. Lucas
Attorney, Agent, or Firm—Francis X. Lo Jacono, Sr.

[57] CLAIM

The ornamental design for a light fixture, as shown and described.

DESCRIPTION

FIG. 1 is a perspective view of a light fixture showing my new design;

FIG. 2 is a top plan view thereof on a reduced scale;

FIG. 3 is a bottom plan view thereof on a reduced scale;

FIG. 4 is a side-elevational view thereof on a reduced scale;

FIG. 5 is perspective view of an alternative embodiment of my new design for a light fixture;

FIG. 6 is a top plan view thereof on a reduced scale;

FIG. 7 is a bottom plan view thereof on a reduced scale; and

FIG. 8 is a side elevational view thereof on a reduced scale.

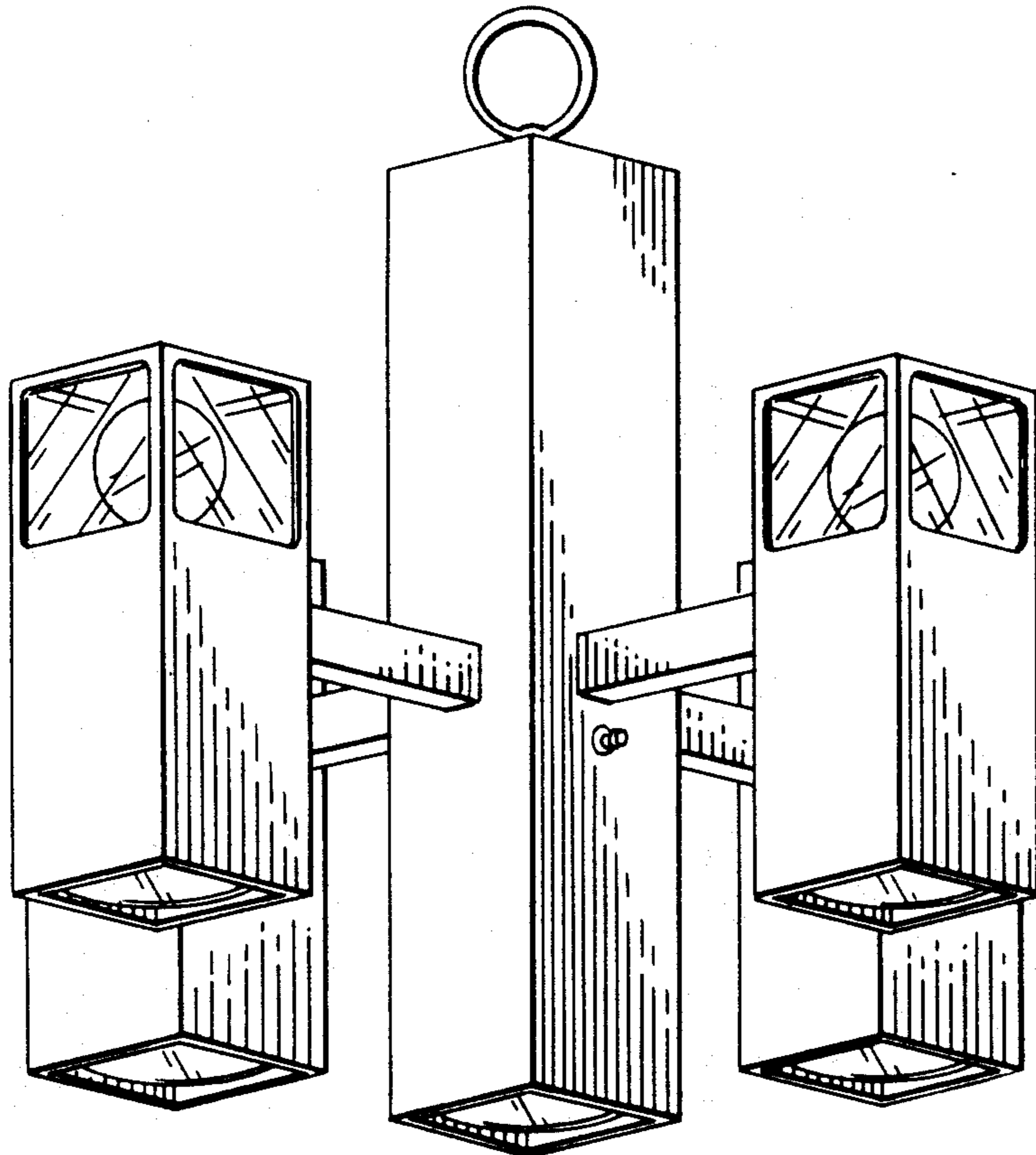

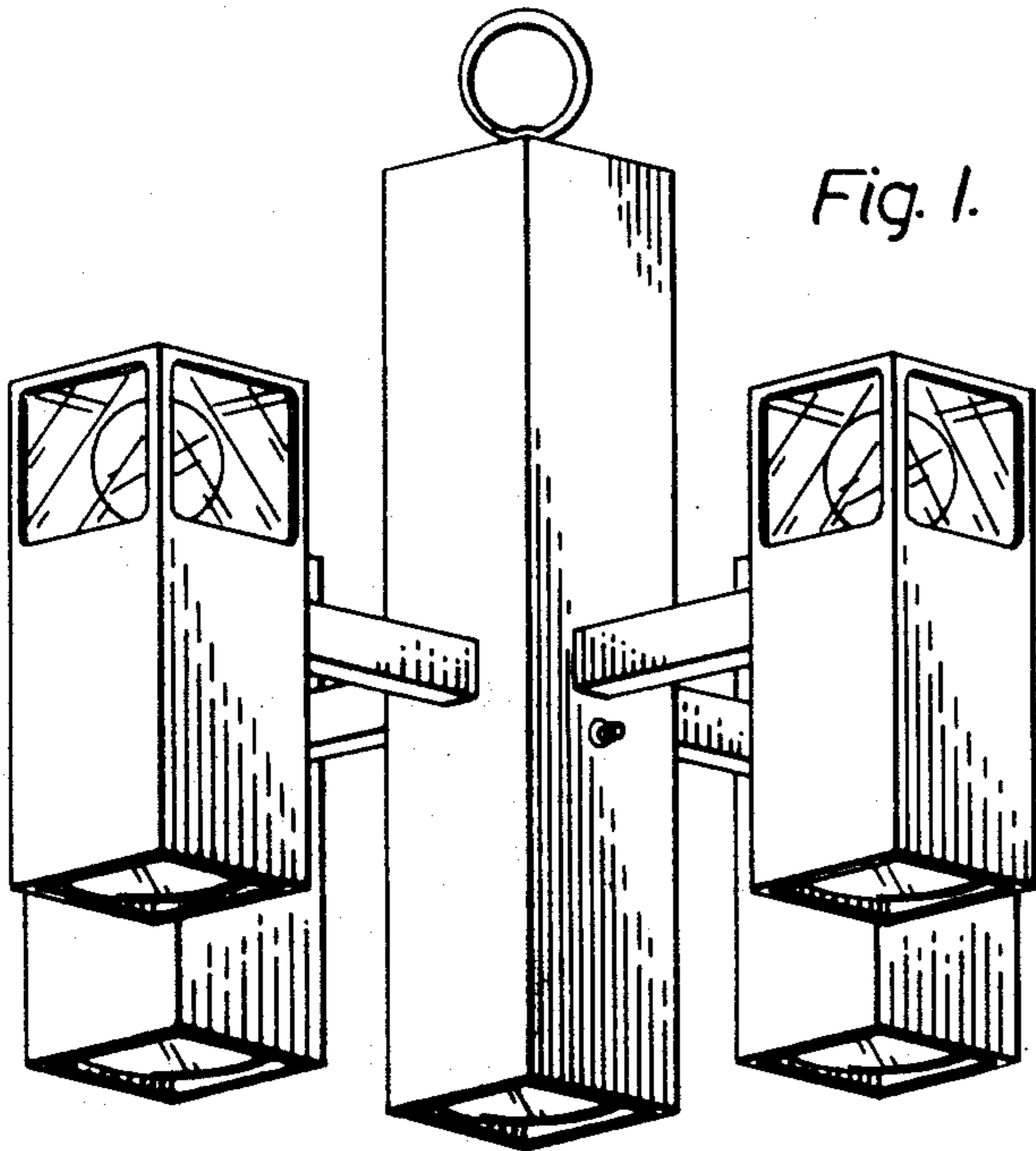

Fig. 1.

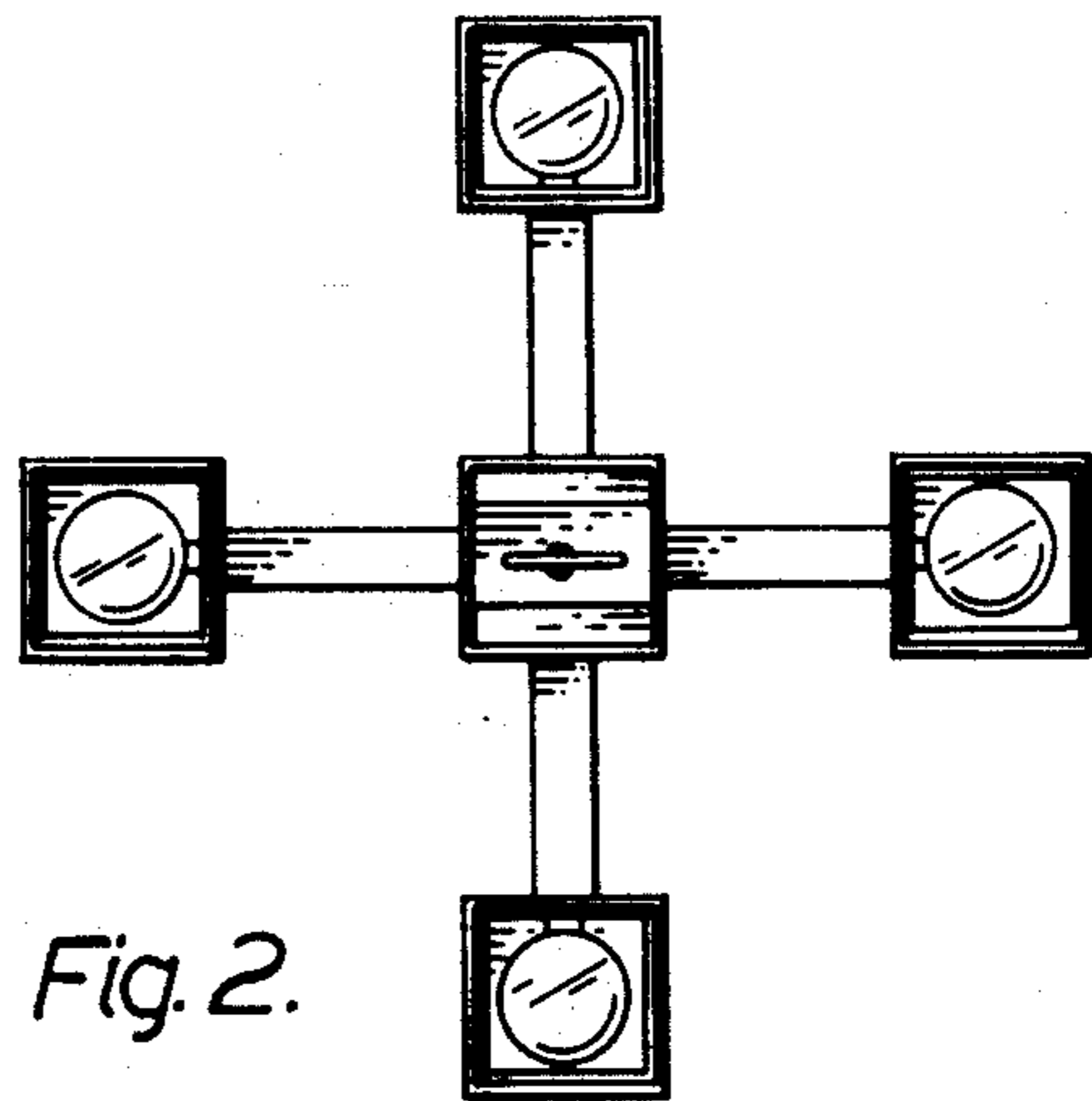

Fig. 2.

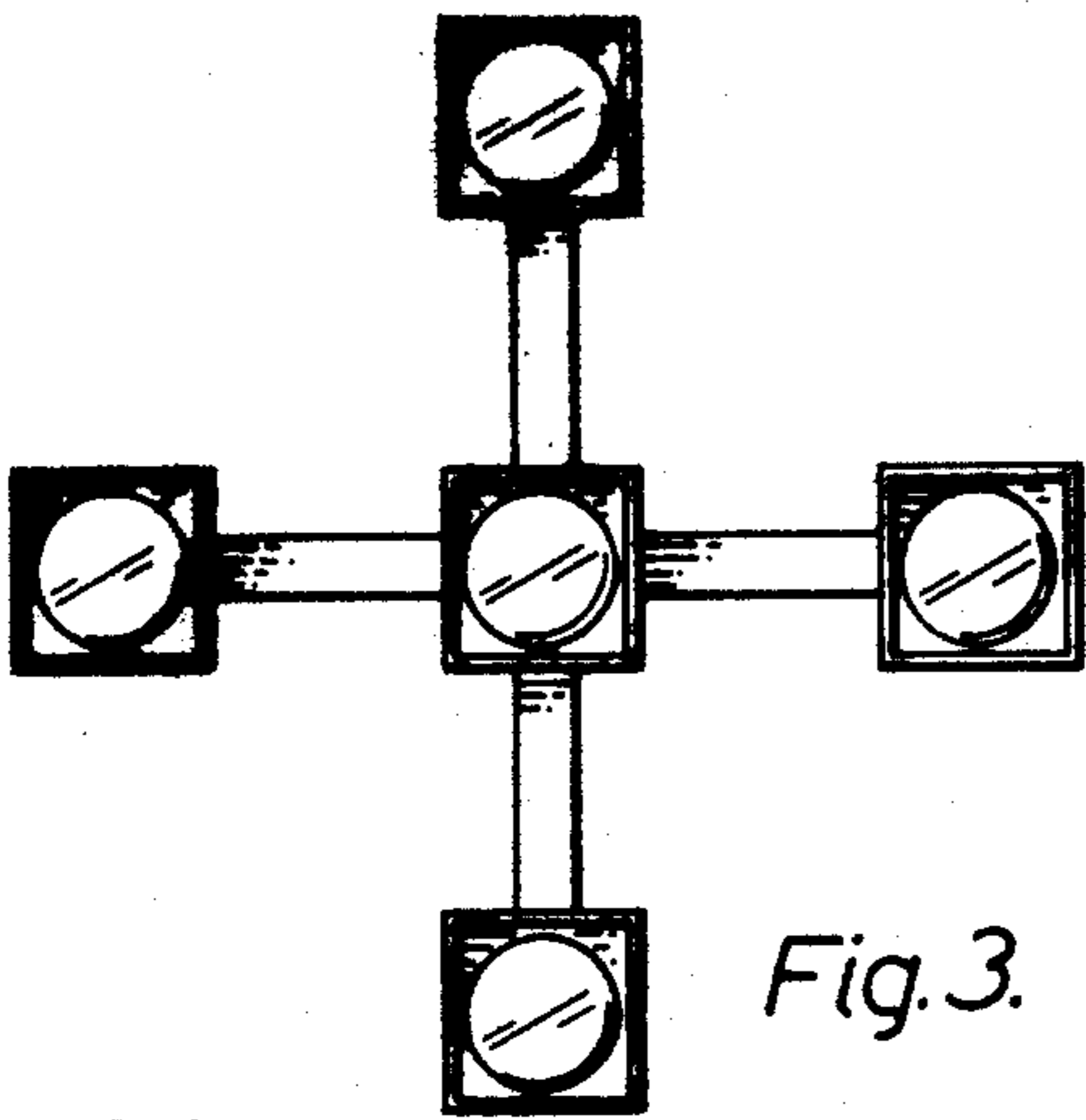

Fig. 3.

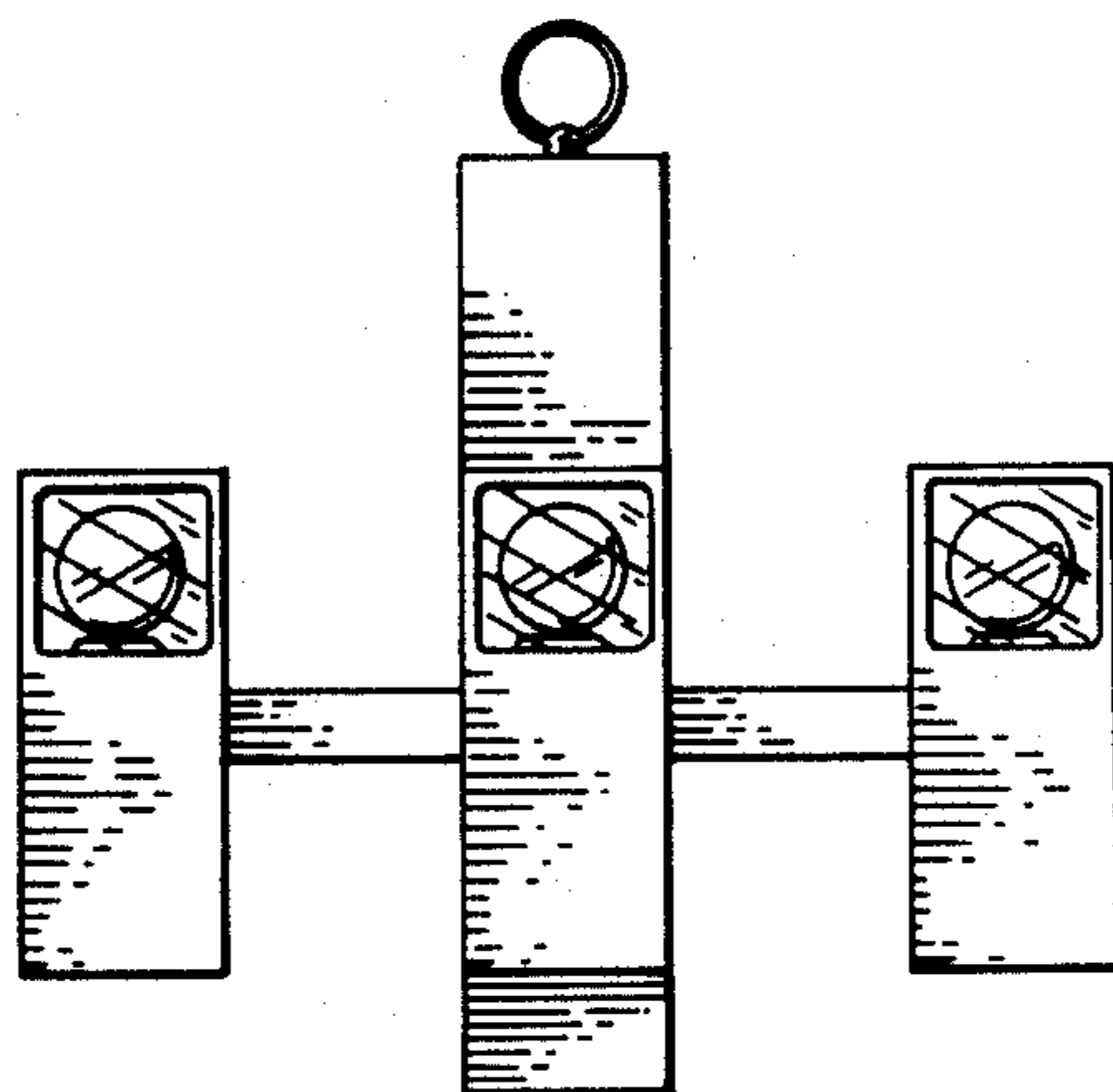

Fig. 4.

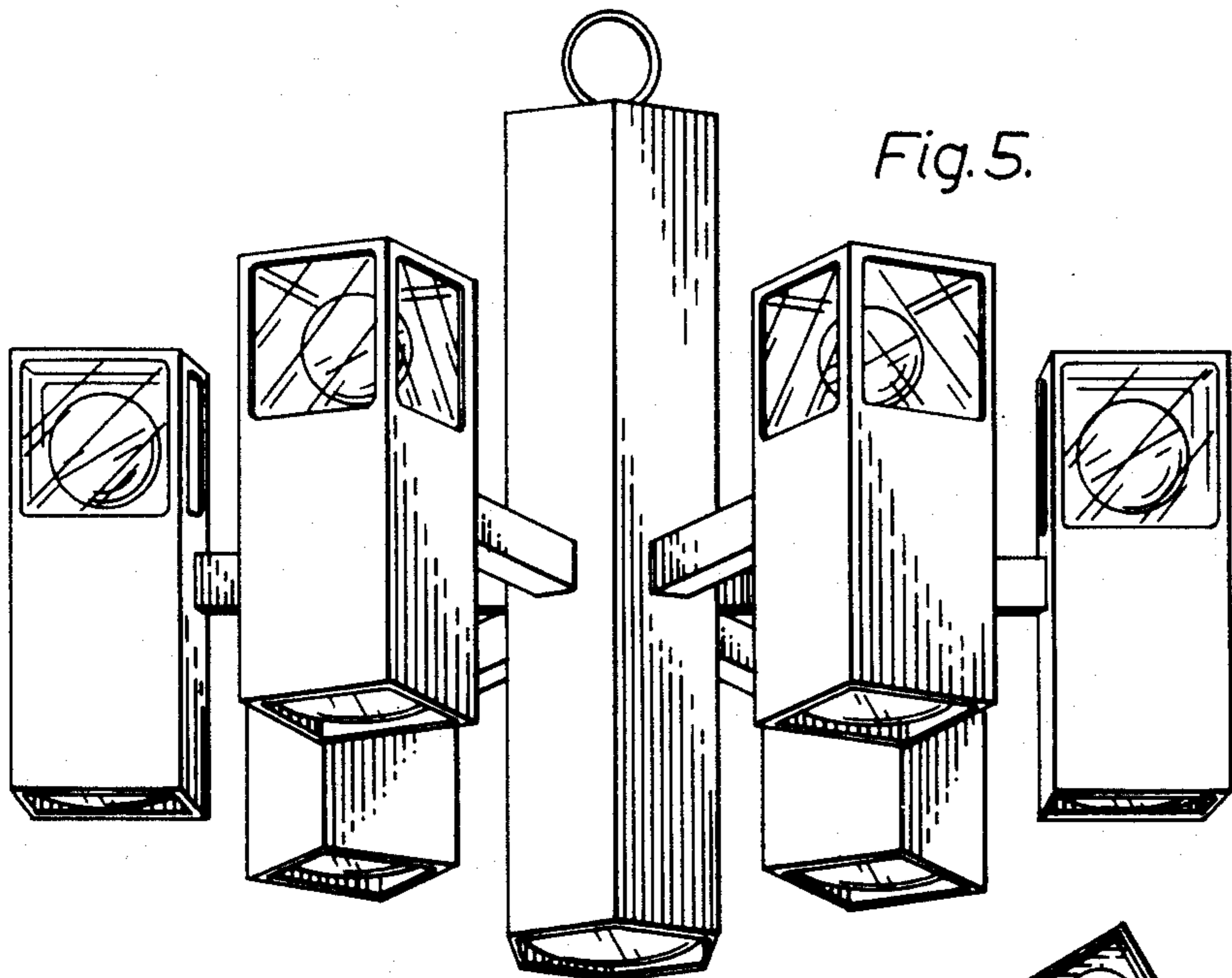

Fig. 6.

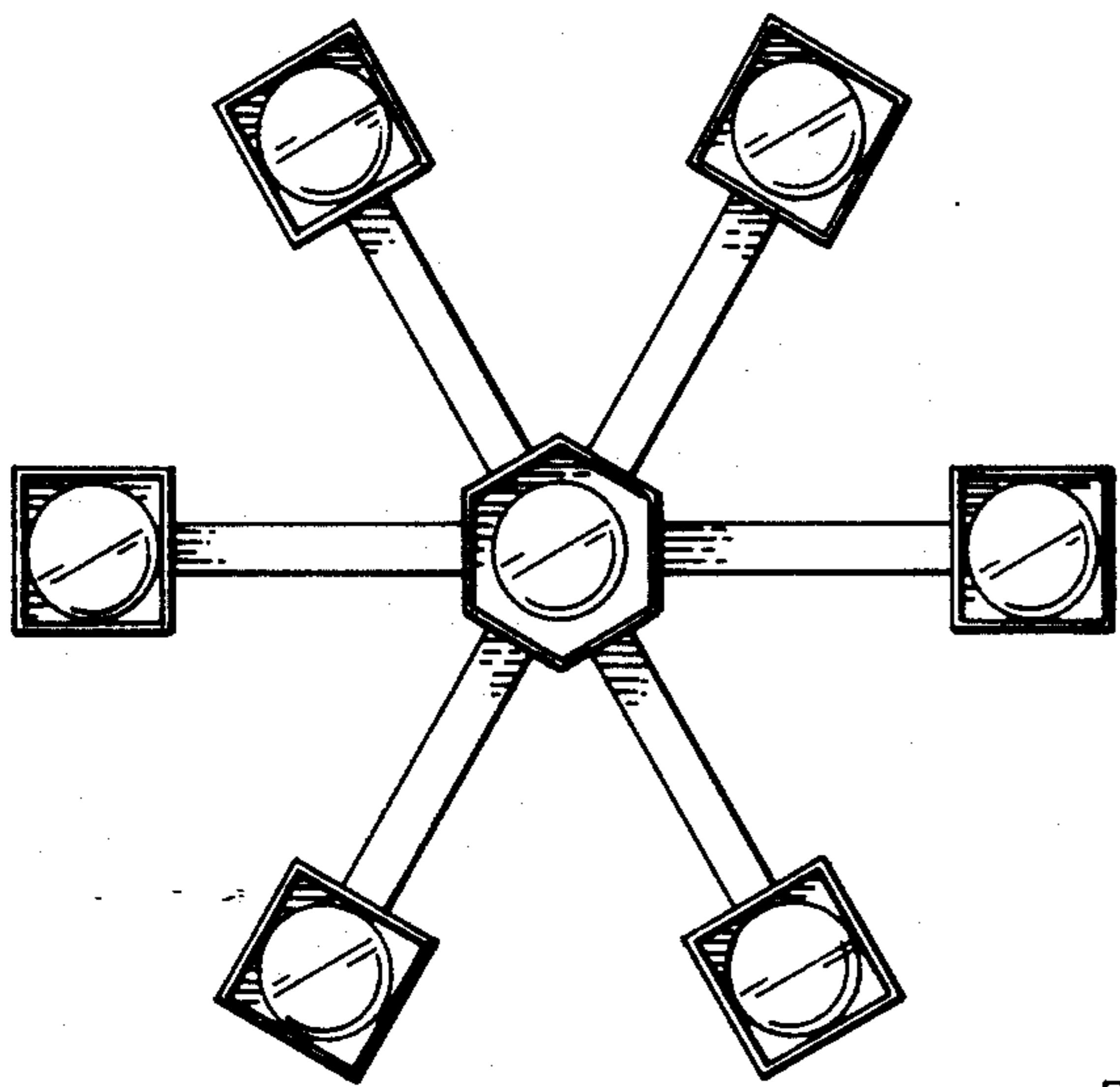
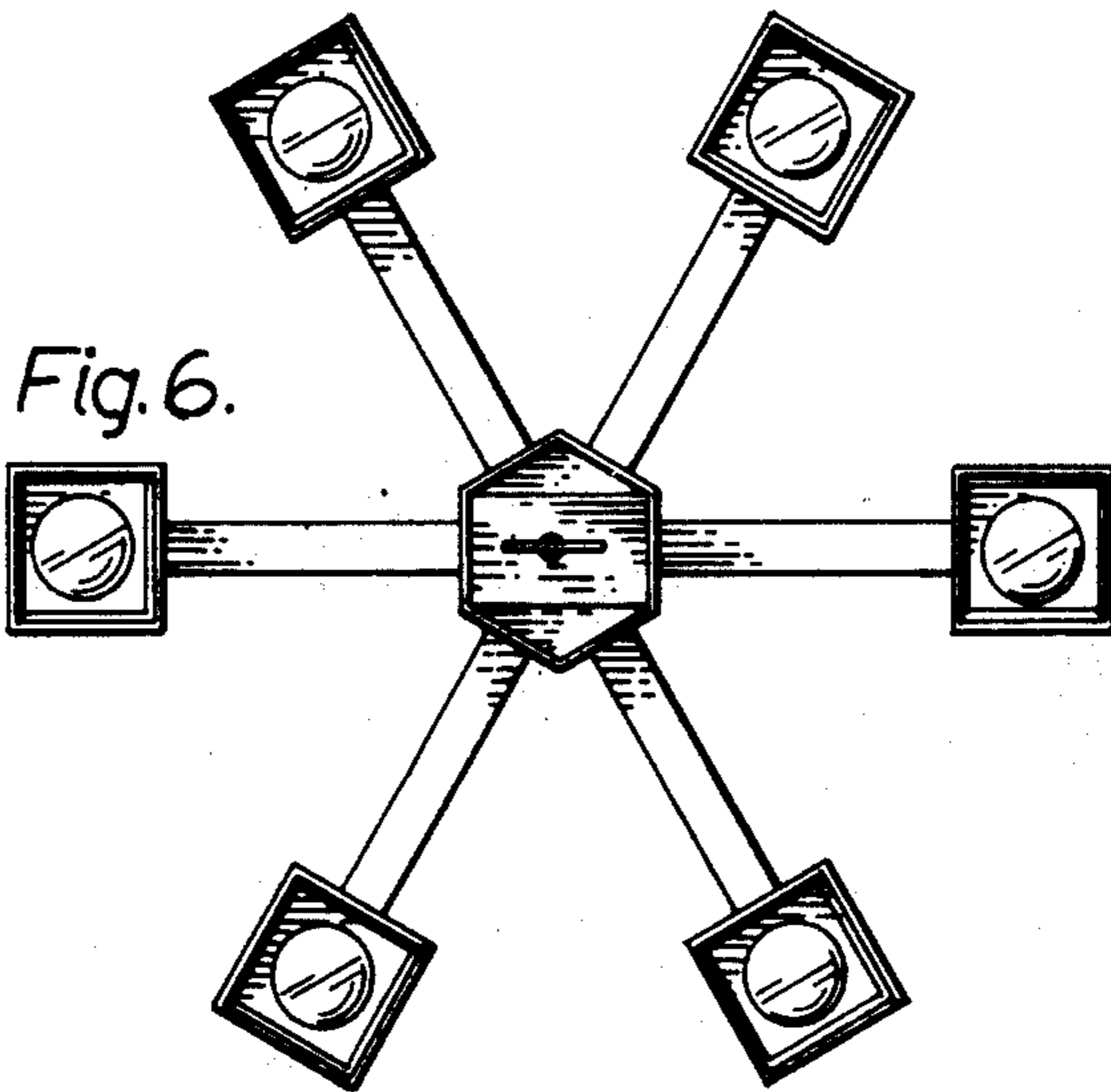

Fig. 8.

