

[54] THEATER CHAIR

[75] Inventor: Leif Blodee, Holland, Mich.

[73] Assignee: American Seating Company, Grand Rapids, Mich.

[\*\*] Term: 14 Years

[21] Appl. No.: 810,117

[22] Filed: Jun. 27, 1977

[51] Int. Cl. .... D6-01

[52] U.S. Cl. .... D6/26; D6/41

[58] Field of Search ..... D6/41, 47, 48, 67-78, D6/20, 22, 26; 297/311, 312, 337

[56] References Cited

U.S. PATENT DOCUMENTS

D. 225,494	12/1972	Ahrens	.....	D6/41
D. 228,104	8/1973	Blodee	.....	D6/41
D. 230,786	3/1974	Barecki	.....	D6/48 X
3,729,226	4/1973	Barecki	.....	D6/48 X

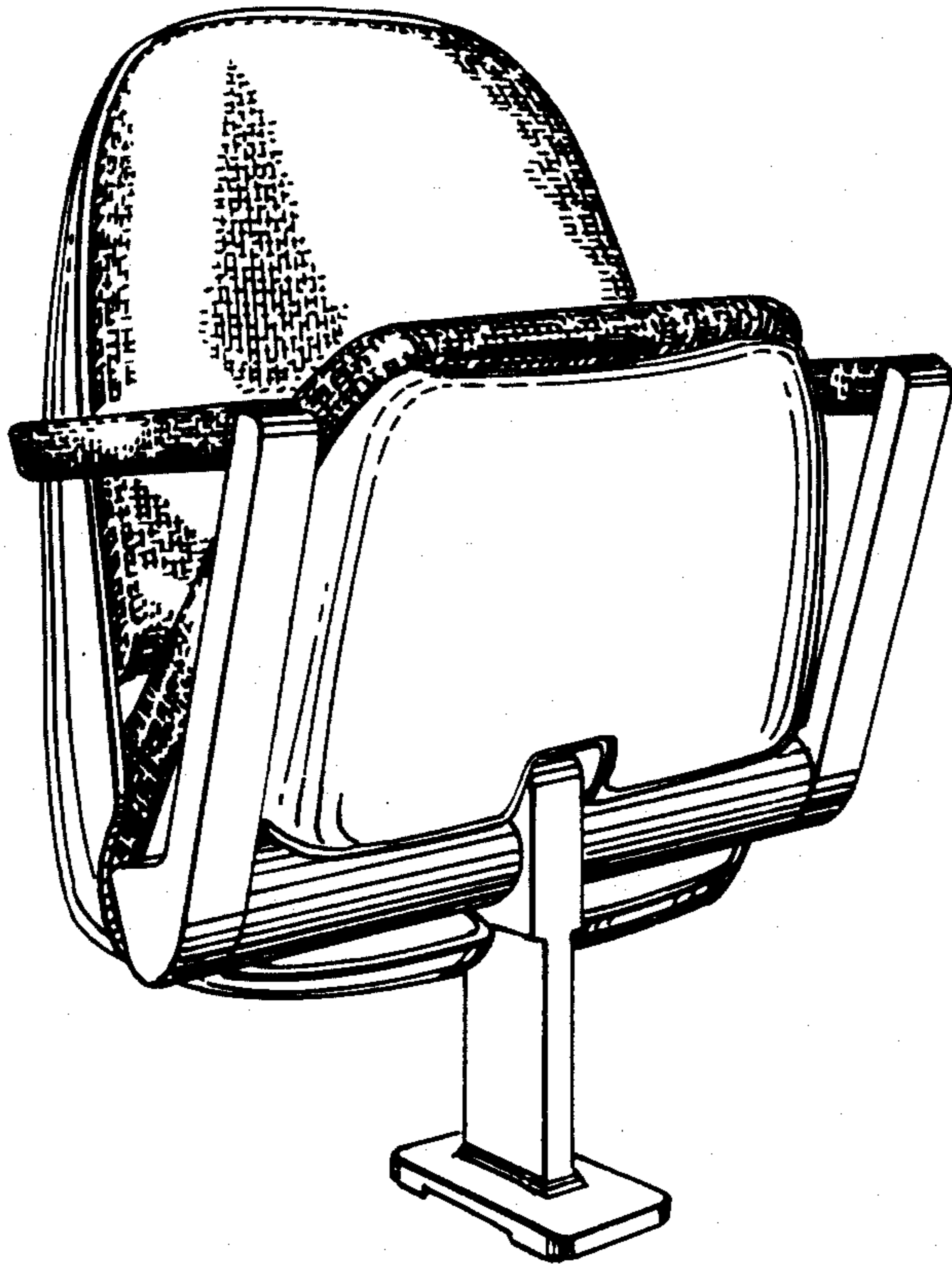
Primary Examiner—Bruce W. Dunkins  
Attorney, Agent, or Firm—Emrich, Root, O'Keefe, Lee

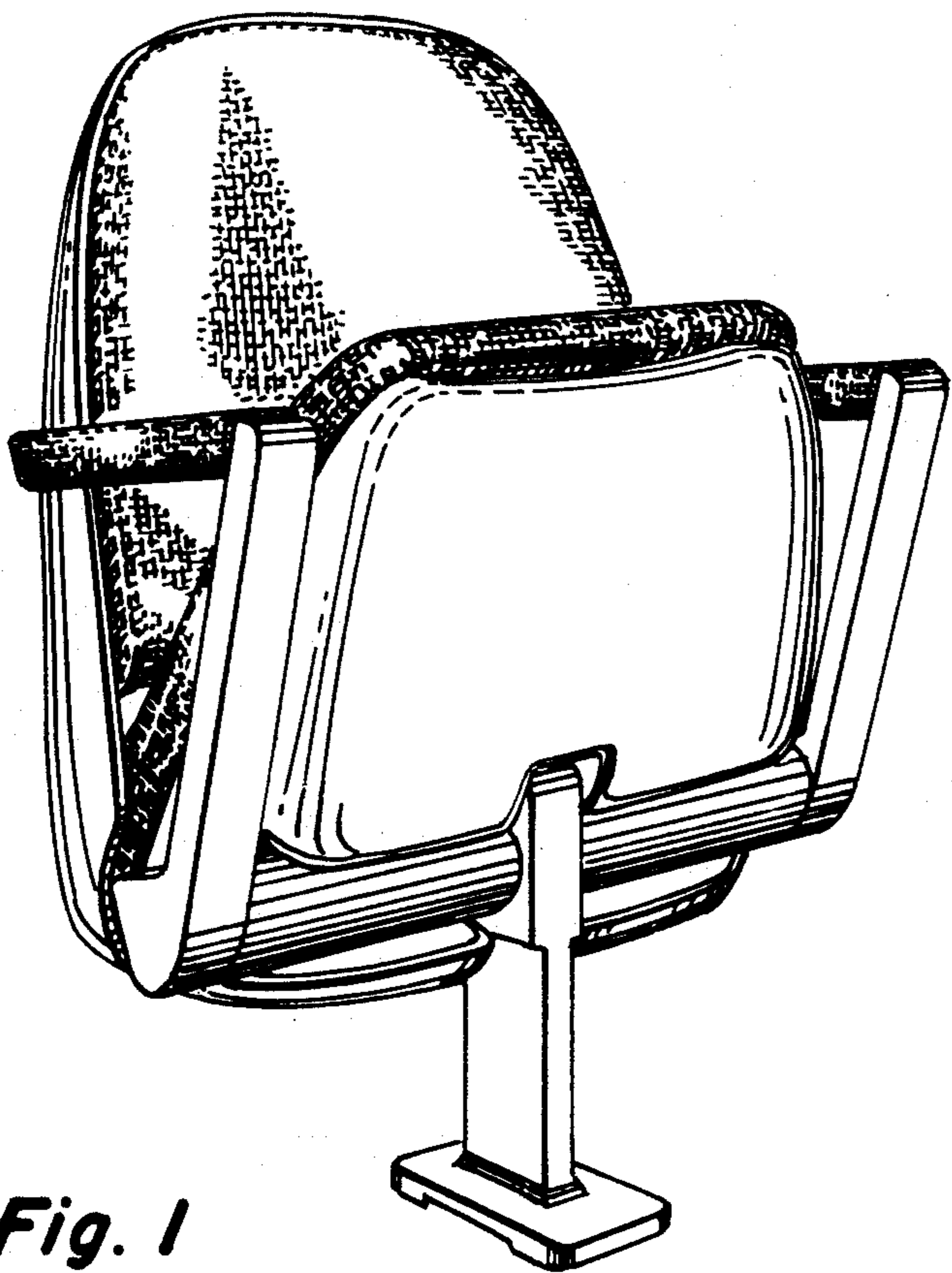
[57] CLAIM

The ornamental design for a theater chair, as shown and described.

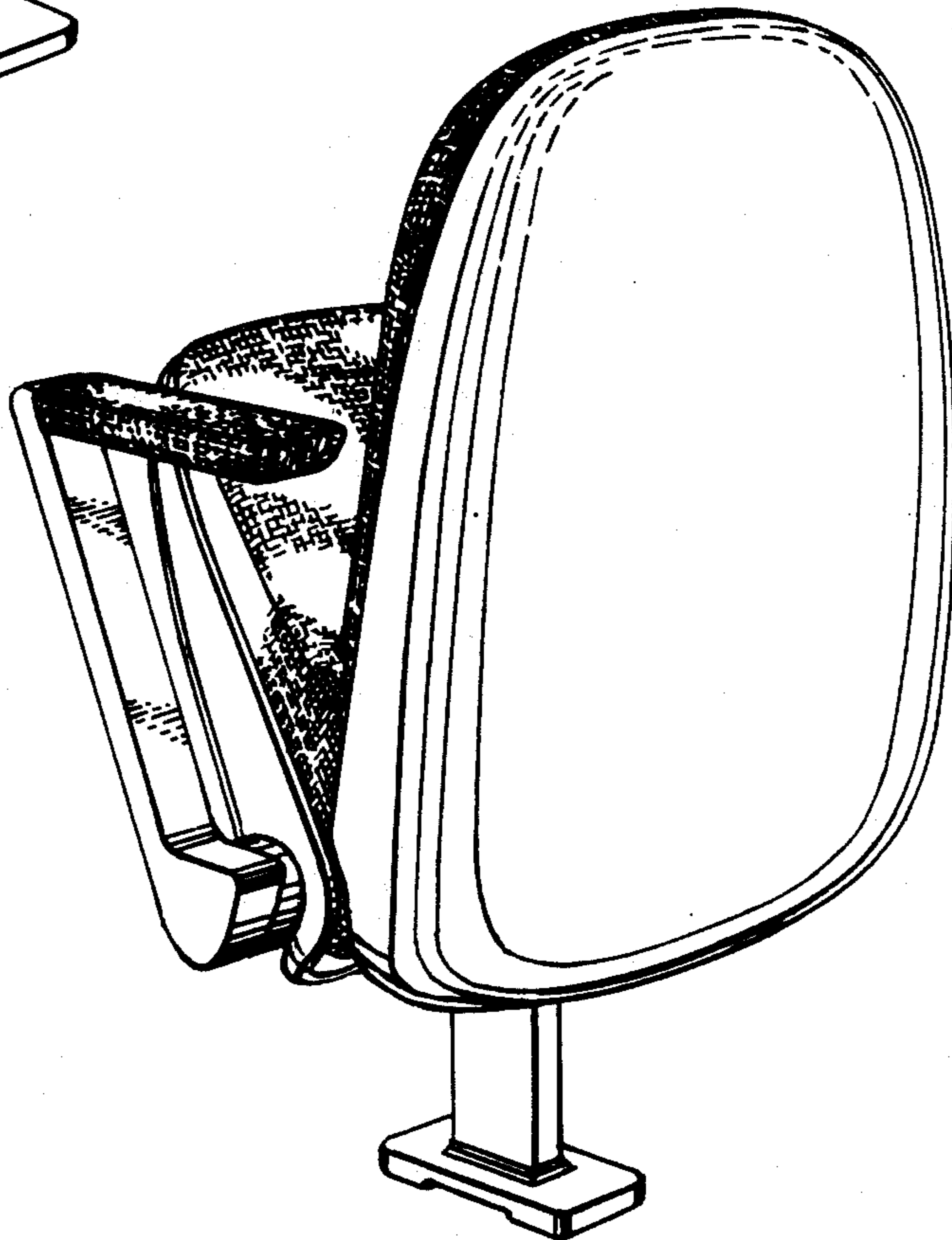
DESCRIPTION

FIG. 1 is a front perspective view of a theater chair showing my design with the seat in the raised position; FIG. 2 is a left rear perspective view of the theater chair of FIG. 1; FIG. 3 is a front elevational view of the chair of FIG. 1; FIG. 4 is a rear view of the chair of FIG. 1; FIG. 5 is a right side view of the chair of FIG. 1; FIG. 6 is a top view of the chair of FIG. 1; FIG. 7 is a modified form of the chair of FIG. 1 with the seat in the lowered position and wherein the chair is supported on a unitary horizontal support member; and FIG. 8 is a side view of the embodiment of FIG. 7. The horizontal support beam shown in FIGS. 7 and 8 is for illustrative purposes only.

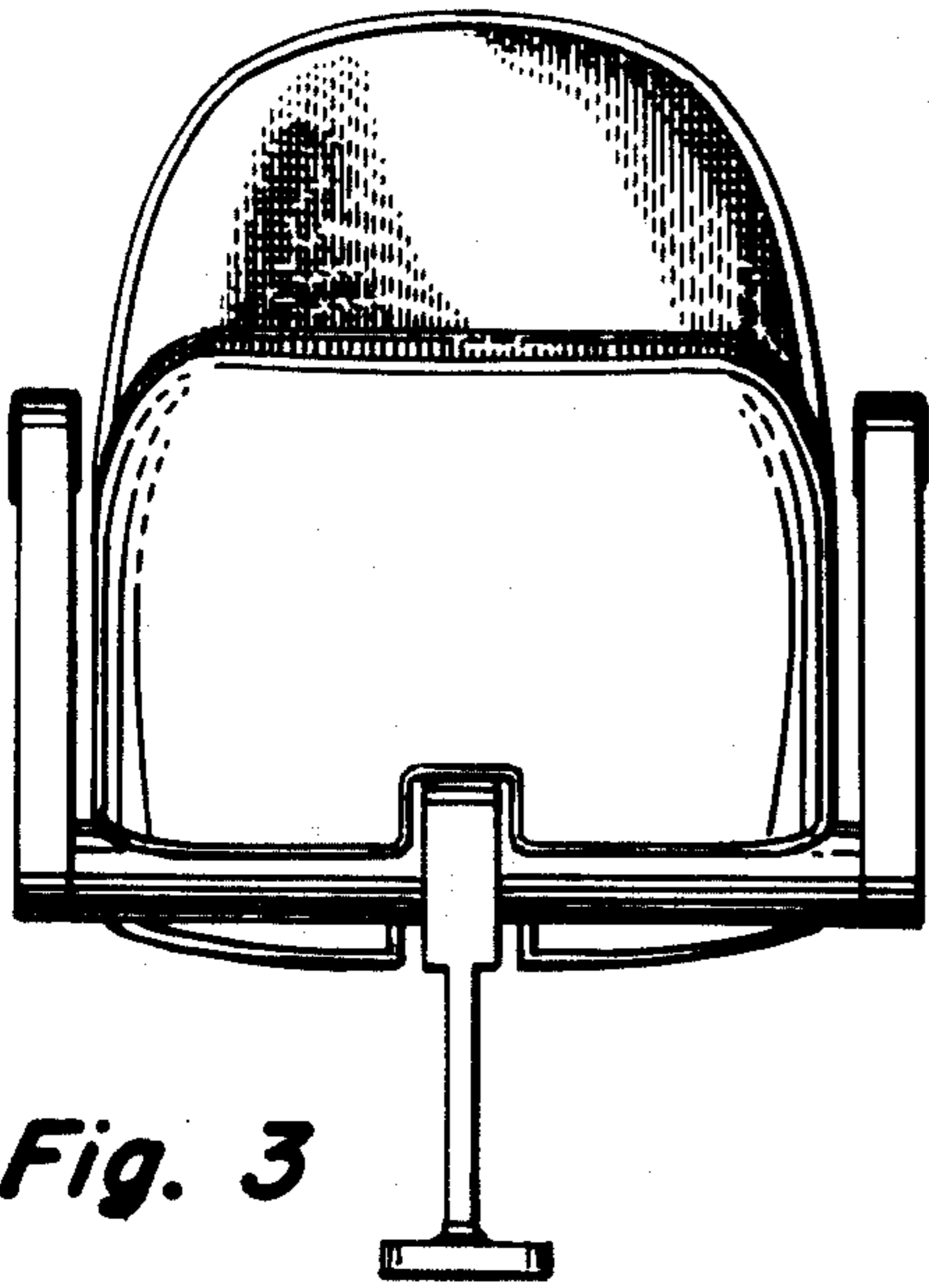




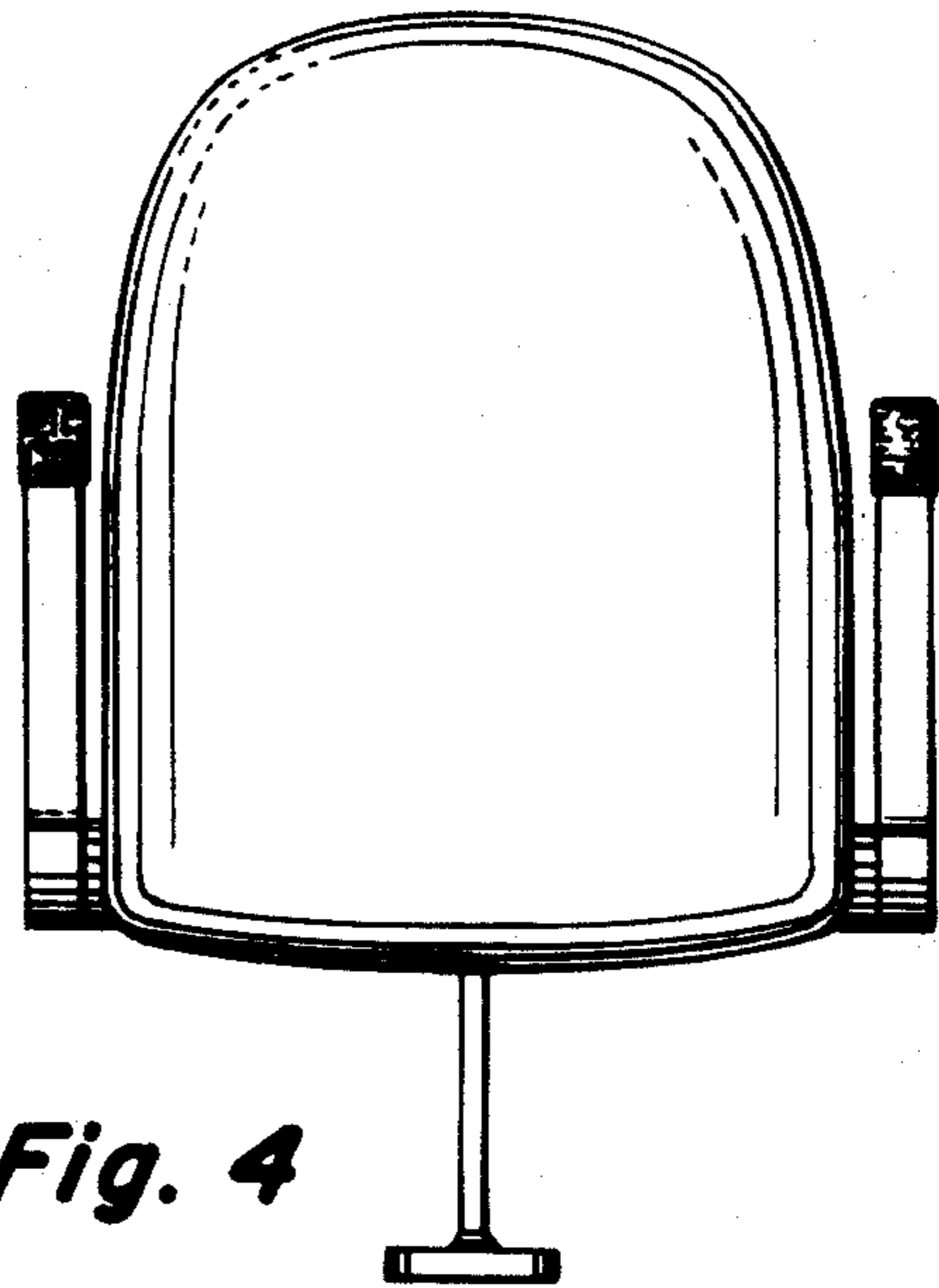
*Fig. 1*



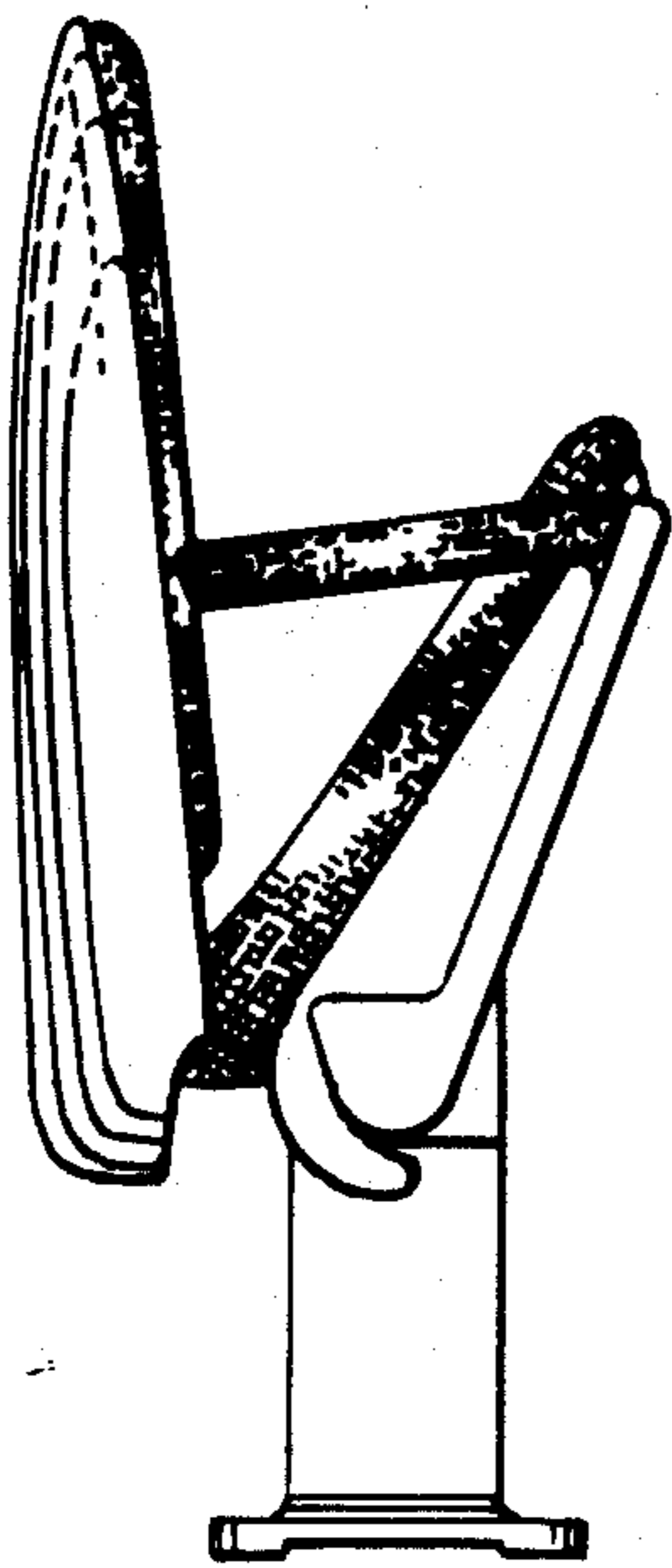
*Fig. 2*



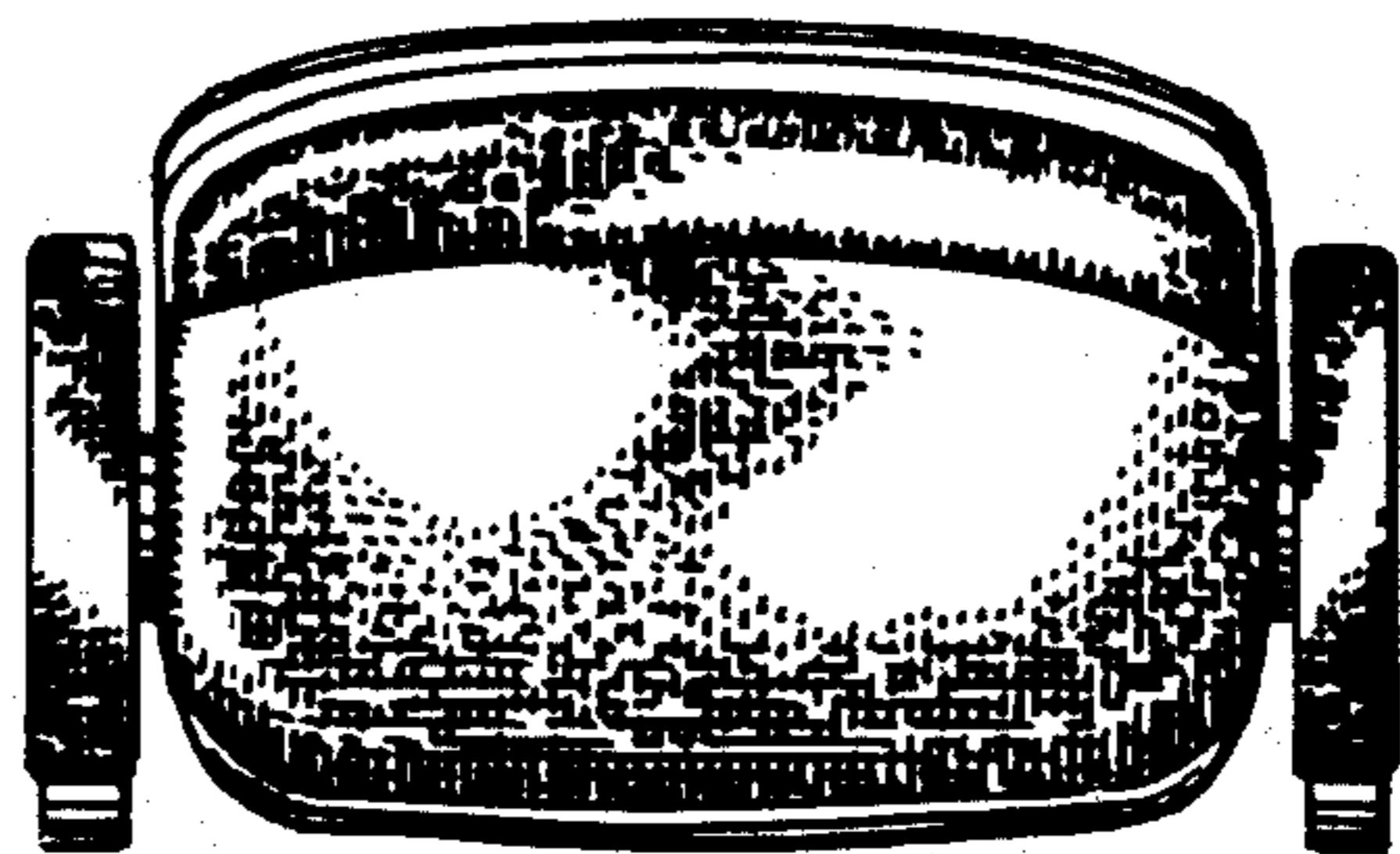
**Fig. 3**



**Fig. 4**

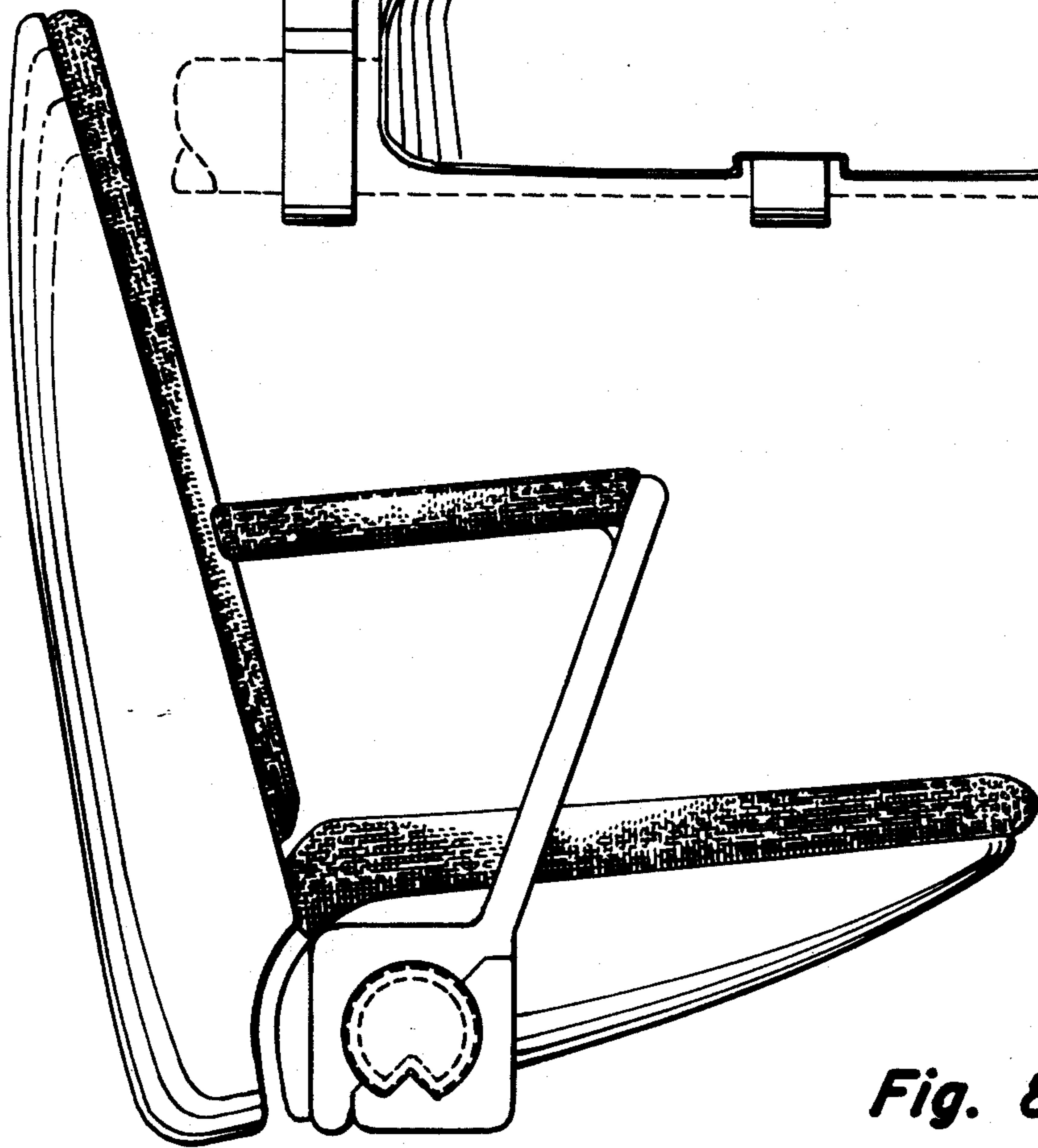
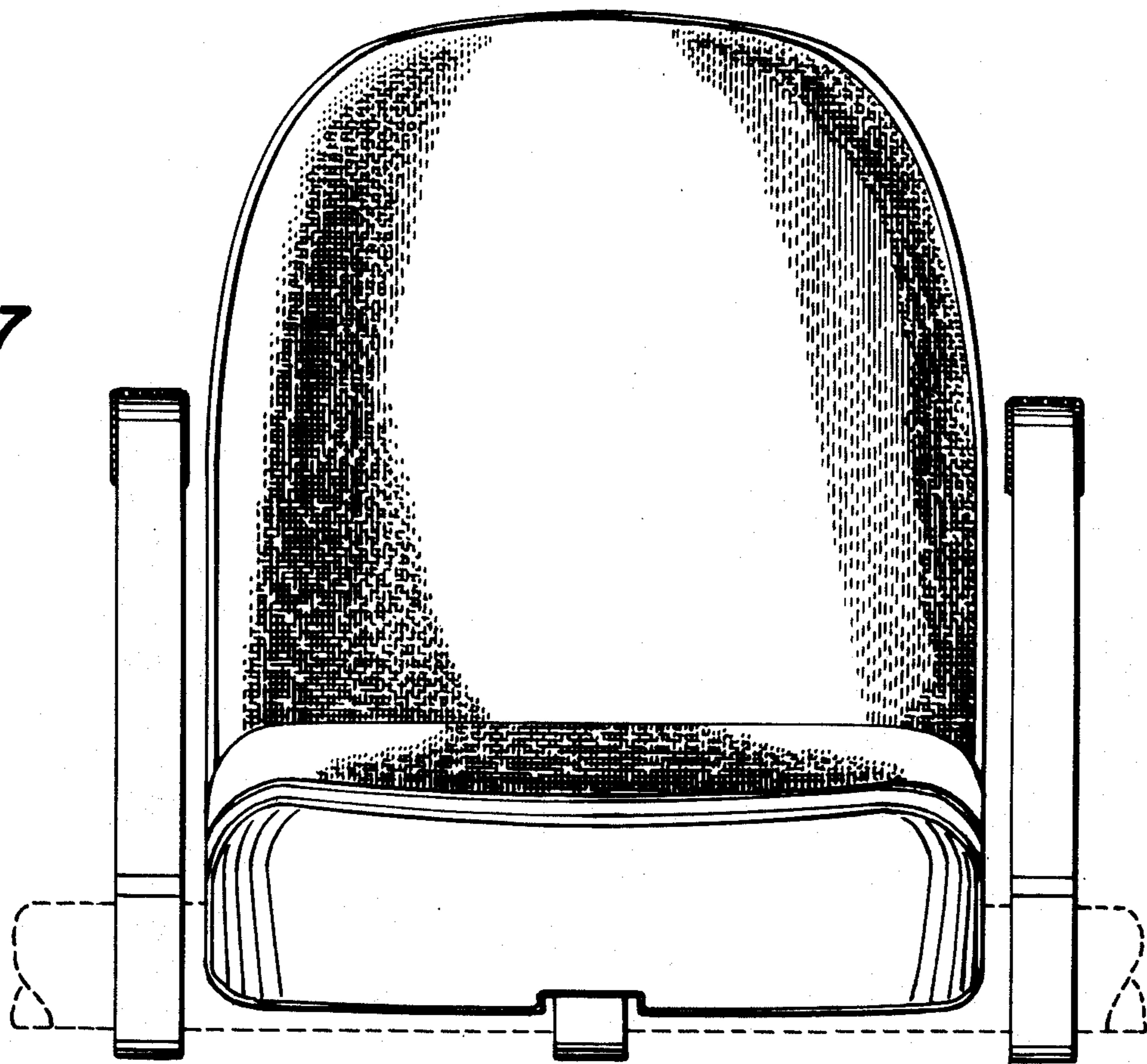


**Fig. 5**



**Fig. 6**

**Fig. 7**



**Fig. 8**