

[54] MULTI-COMPARTMENTED STORAGE RACK FOR SUNDRIES

[76] Inventor: Howard Sussman, c/o Crackerbarrel Marketing Inc., East Shore Rd., Huntington, N.Y. 11743

[**] Term: 14 Years

[21] Appl. No.: 797,586

[22] Filed: May 16, 1977

[51] Int. Cl. D6-04

[52] U.S. Cl. D6/189; D6/130

[58] Field of Search D19/90; D6/181-190, D6/157, 167-171, 114, 127, 130, 132, 134; 211/134, 135, 153

[56] References Cited

U.S. PATENT DOCUMENTS

D. 162,511	3/1951	Bauer et al.	D6/189
D. 210,784	4/1968	Pond	D6/189
D. 213,323	2/1969	Salvatore et al.	D6/189
D. 214,920	8/1969	Cashman	D6/189

D. 242,313 11/1976 Stentz D6/181

OTHER PUBLICATIONS

"Lit-Ning Products" Catalog ©1966, p. 6, Desk Top Book Rack No. 13BR.

"Lit-Ning Products" Brochure p. 2, Storage Rack No. 5110.

Primary Examiner—Bruce W. Dunkins
Attorney, Agent, or Firm—Jerome Bauer

[57] CLAIM

The ornamental design for a multi-compartmented storage rack for sundries, substantially as shown.

DESCRIPTION

FIG. 1 is a view in front elevation of a multi-compartmented storage rack for sundries showing my design; FIG. 2 is a plan view; FIG. 3 is a left side view; FIG. 4 is a right side view; FIG. 5 is a bottom view; FIG. 6 is a rear elevational view; and FIG. 7 is a view showing the article, for convenience of illustration, in exploded perspective.

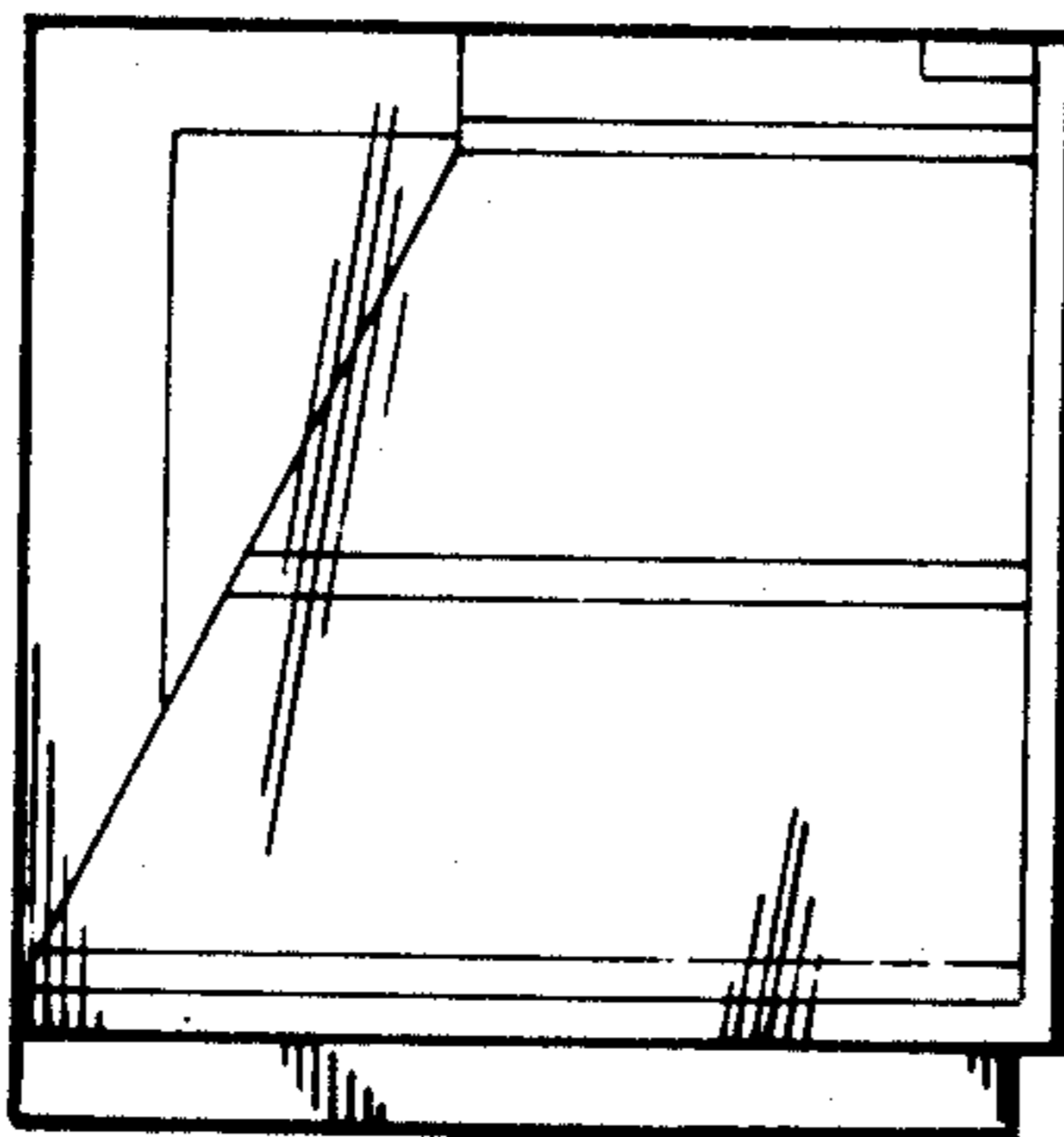
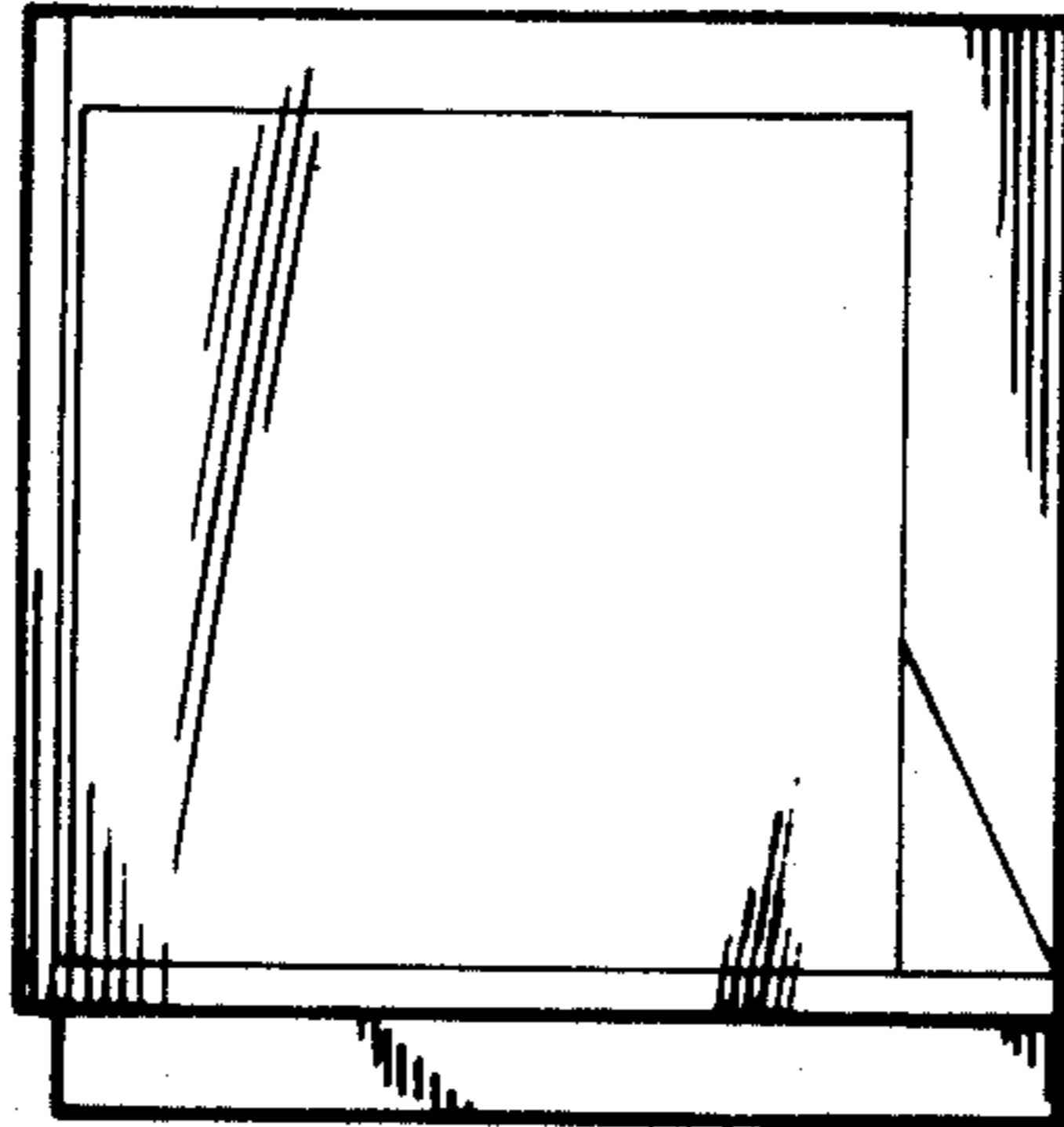

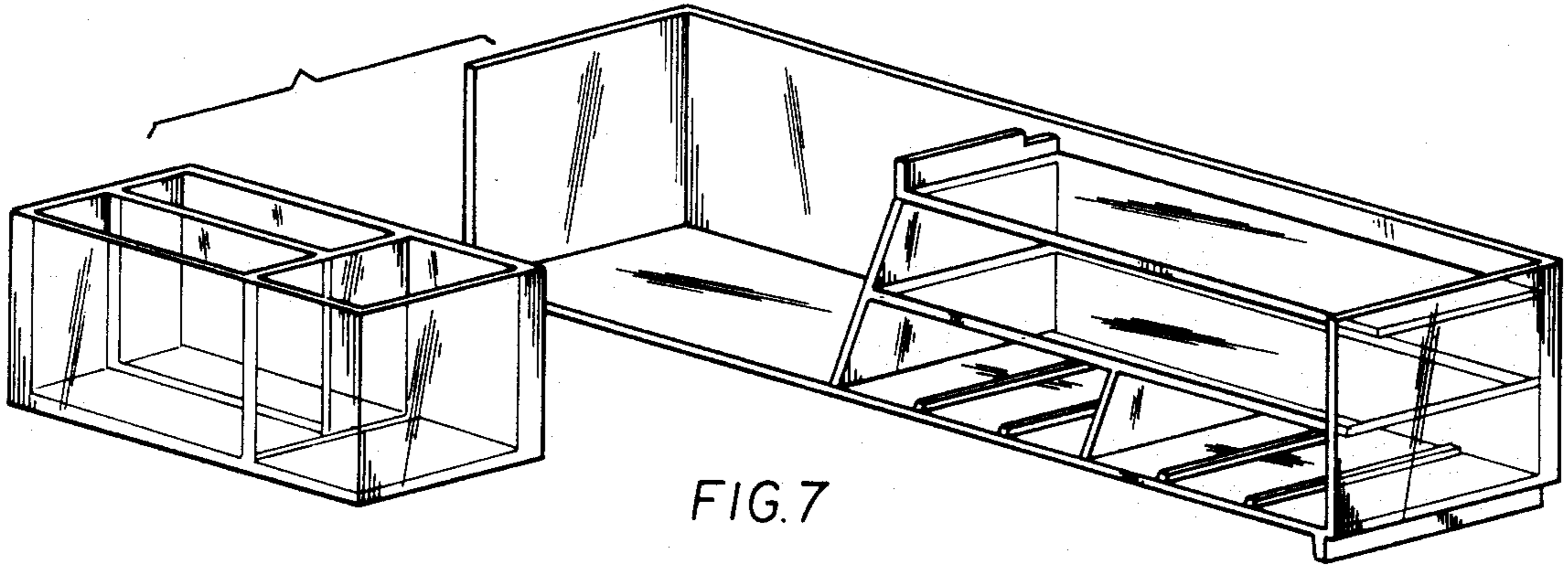

FIG. 7

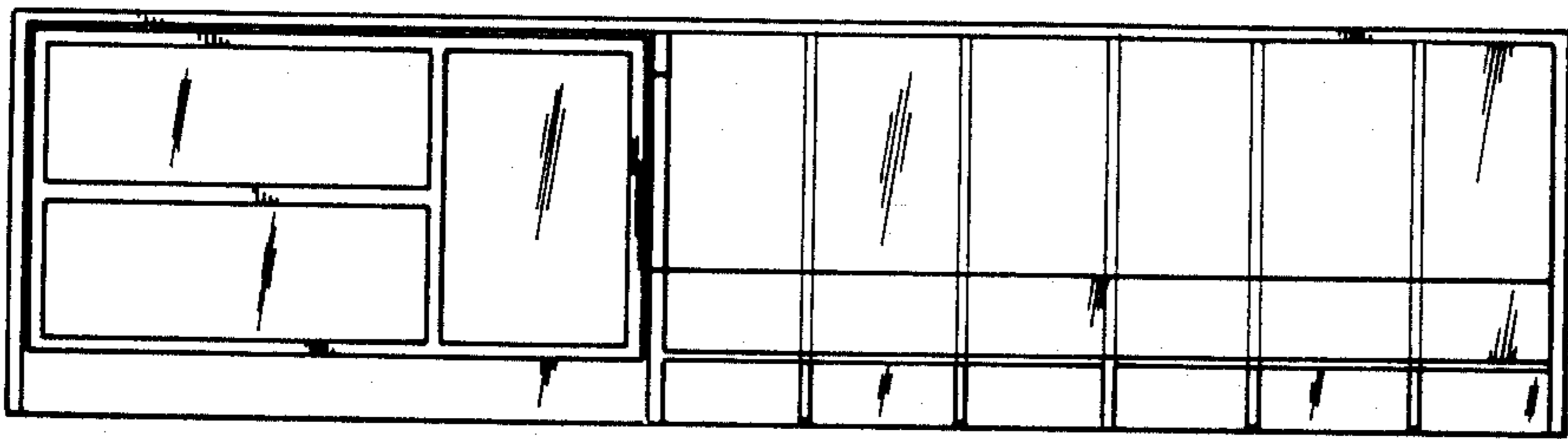

FIG. 2

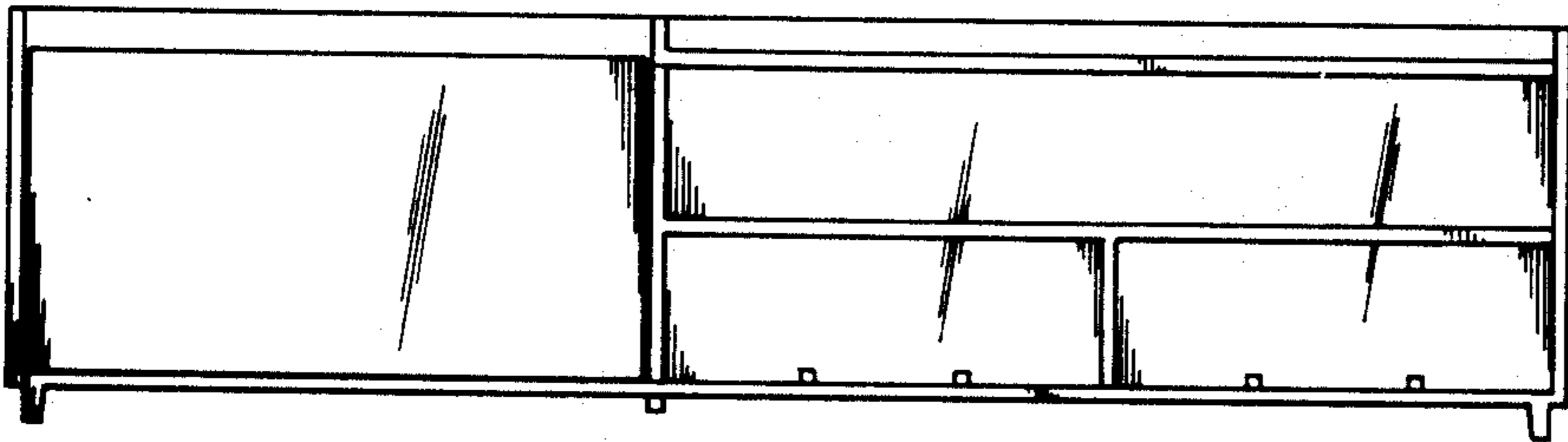

FIG. 1

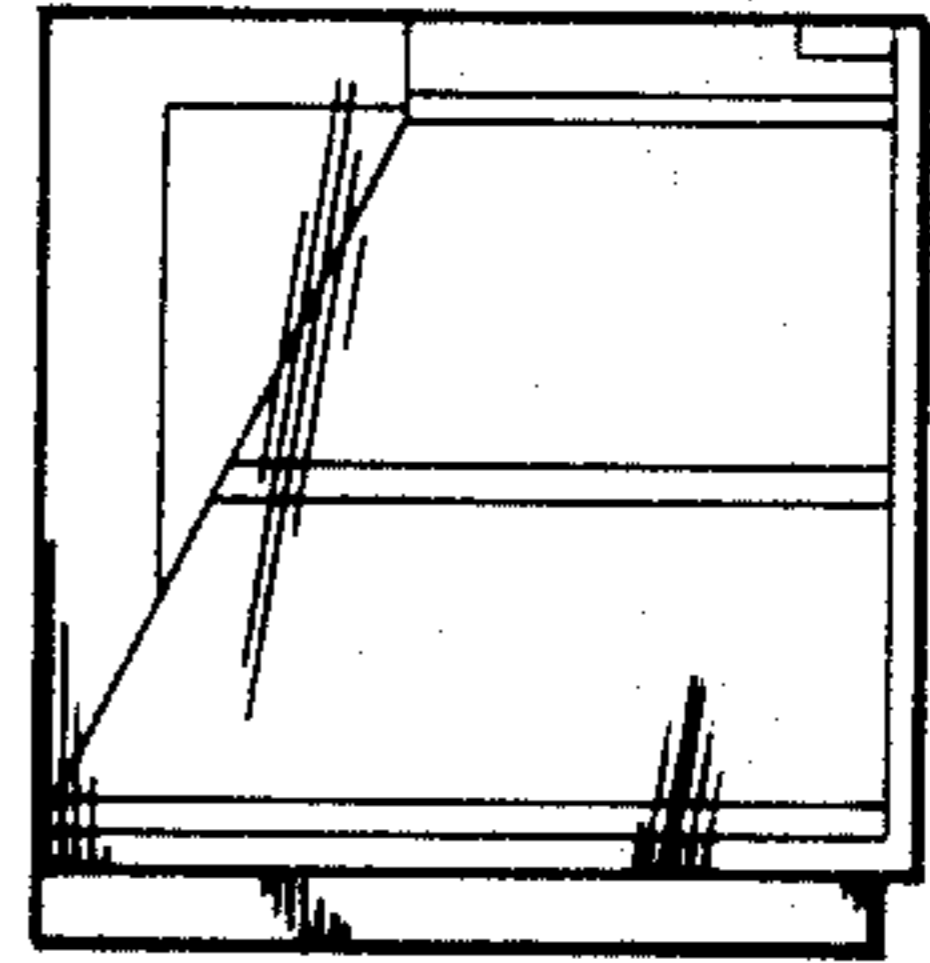

FIG. 4

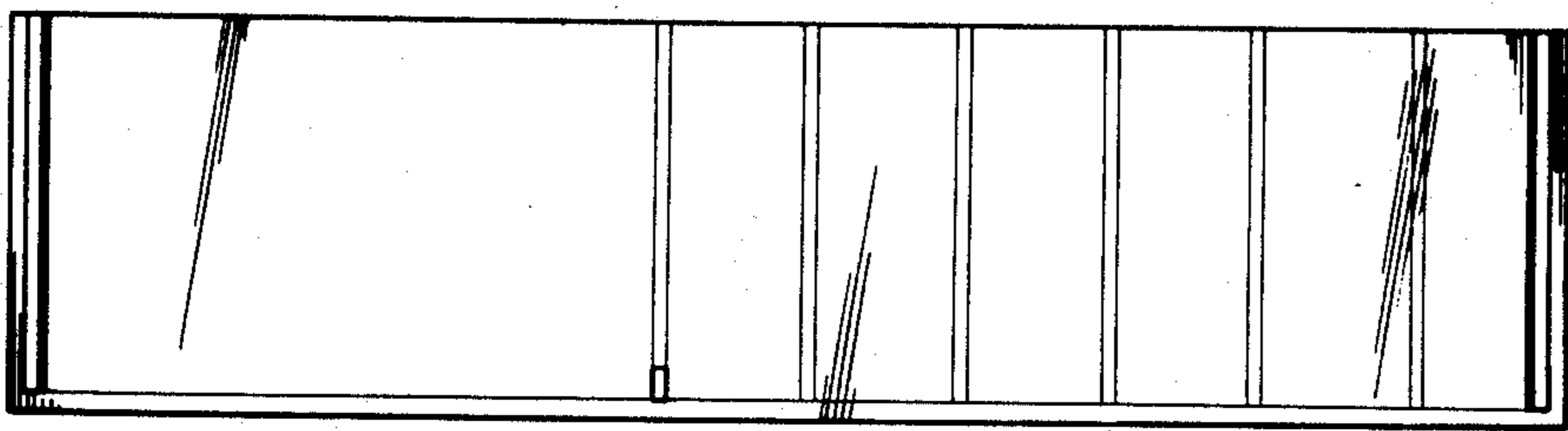

FIG. 5

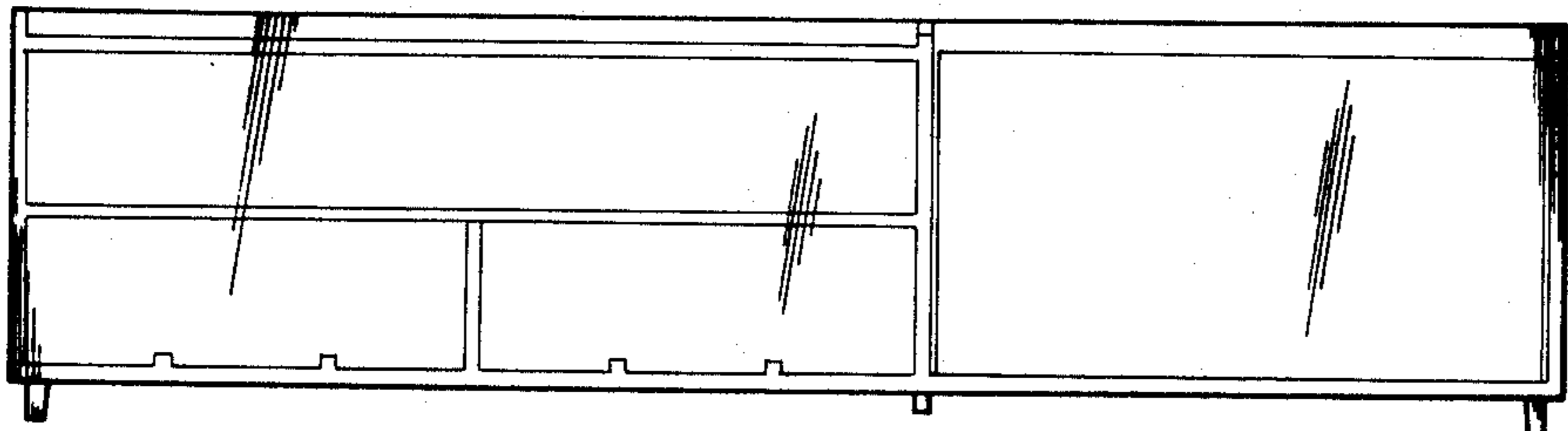

FIG. 6

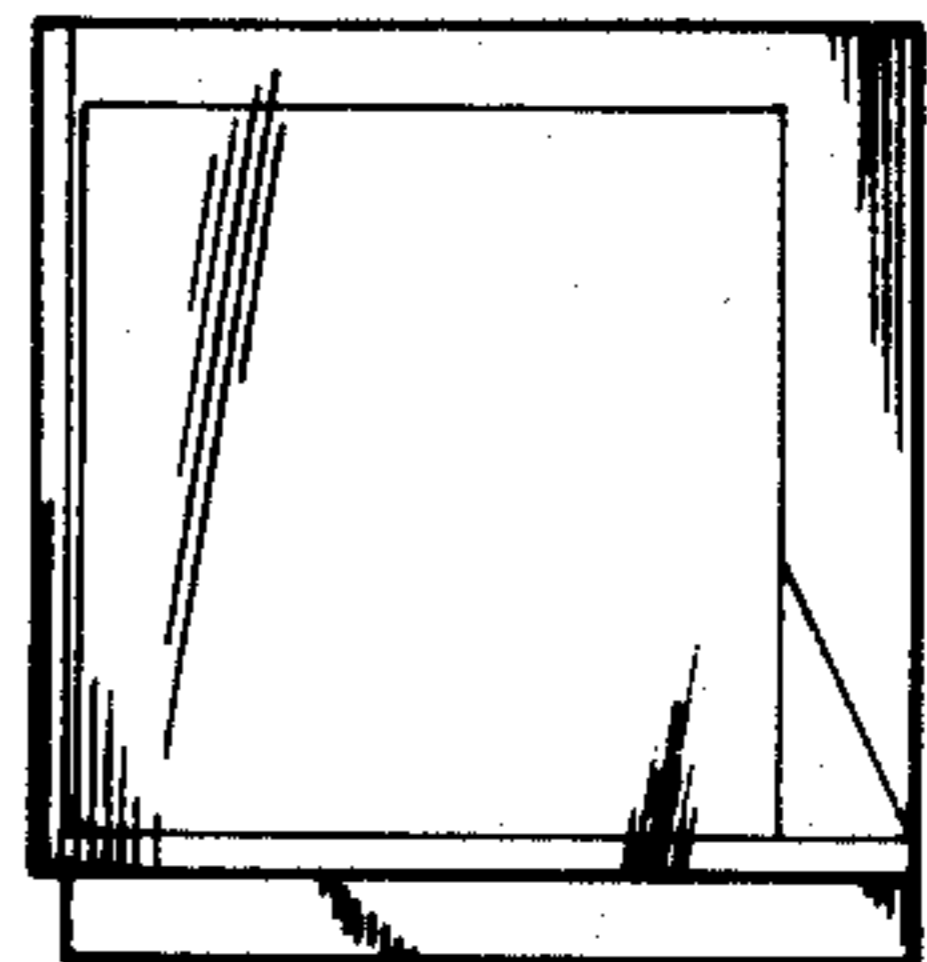

FIG. 3