

[54] SKATEBOARD

[76] Inventor: John S. Solheim, 529 W. Wakonda La., Phoenix, Ariz. 85023

[\*\*] Term: 14 Years

[21] Appl. No.: 837,561

[22] Filed: Sep. 28, 1977

[51] Int. Cl. .... D21-01

[52] U.S. Cl. .... D21/227

[58] Field of Search ..... D34/15 AJ, 14 C, 15 AT; 280/87.04 R, 87.04 A, 87.04 B

[56] References Cited

U.S. PATENT DOCUMENTS

D. 200,917 4/1965 Markham ..... D34/15 AJ  
3,954,279 5/1976 Guerr ..... 280/87.04 A

OTHER PUBLICATIONS

Skateboarder, 11-1977, p. 7, "Dirt Board" at bottom of page.

Primary Examiner—Joel Stearman  
Assistant Examiner—Charles A. Rademaker  
Attorney, Agent, or Firm—Antonio M. Fernandez

[57] CLAIM

The ornamental design for a skateboard, substantially as shown.

DESCRIPTION

FIG. 1 is a perspective view of a skateboard showing my new design;  
FIG. 2 is a side elevational view thereof;  
FIG. 3 is a top plan view thereof;  
FIG. 4 is a bottom plan view thereof;  
FIG. 5 is a left end elevational view thereof; and,  
FIG. 6 is a right end elevational view thereof.

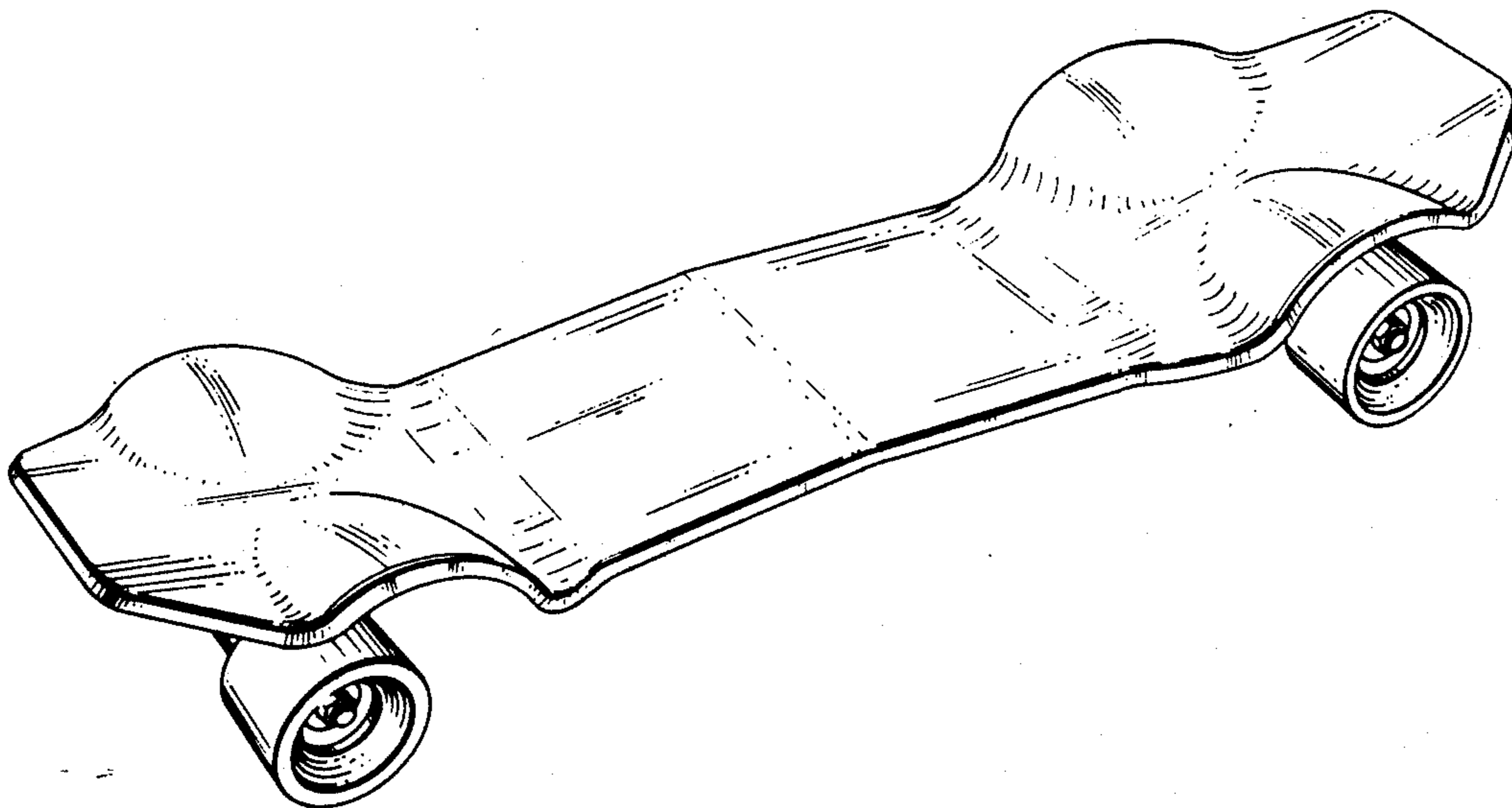

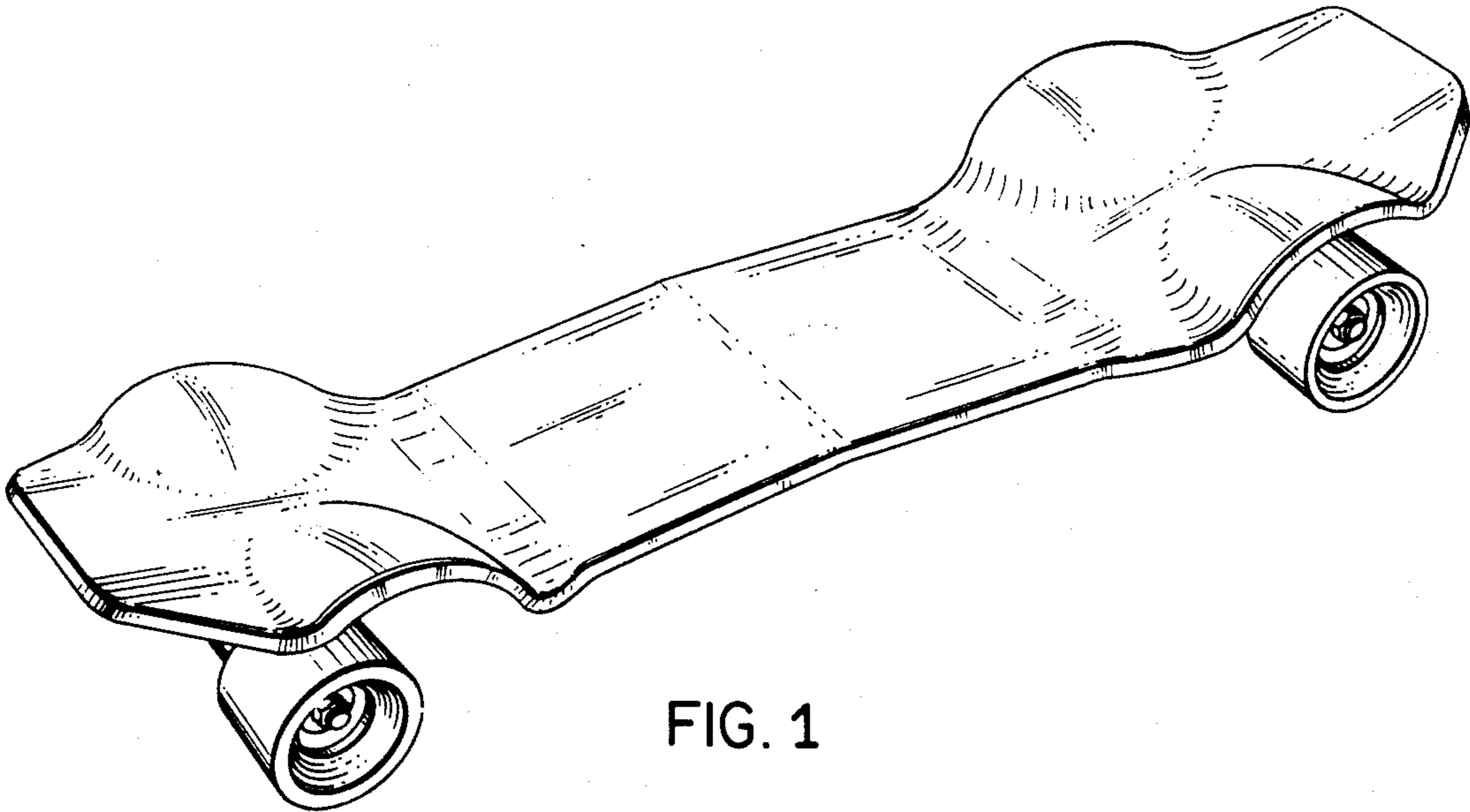

FIG. 1

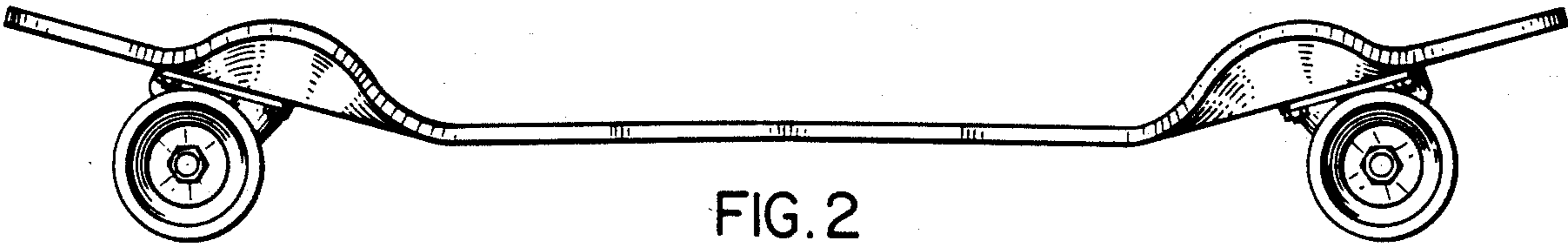

FIG. 2

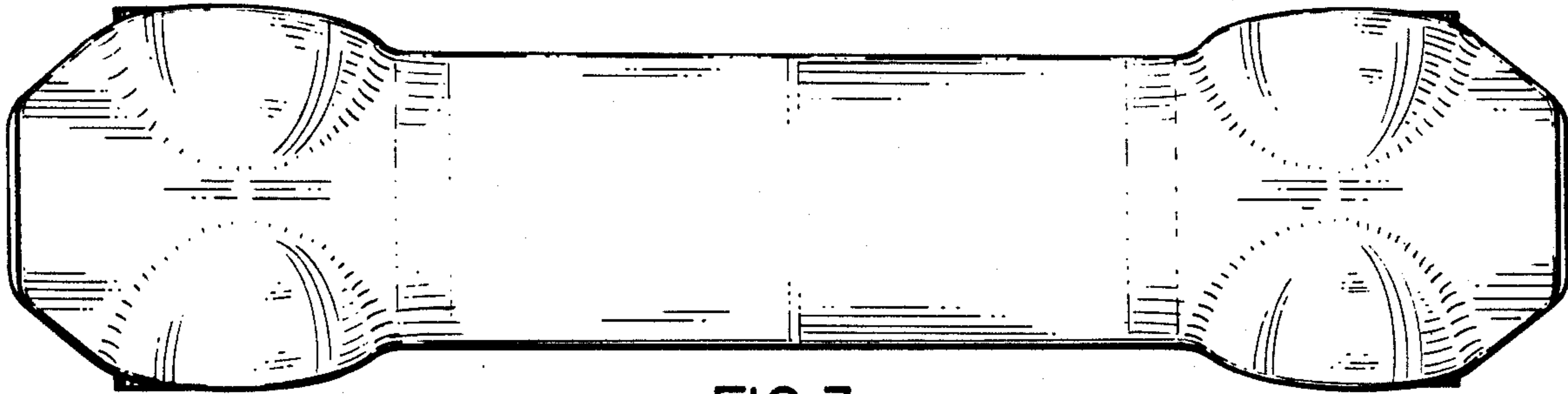

FIG. 3

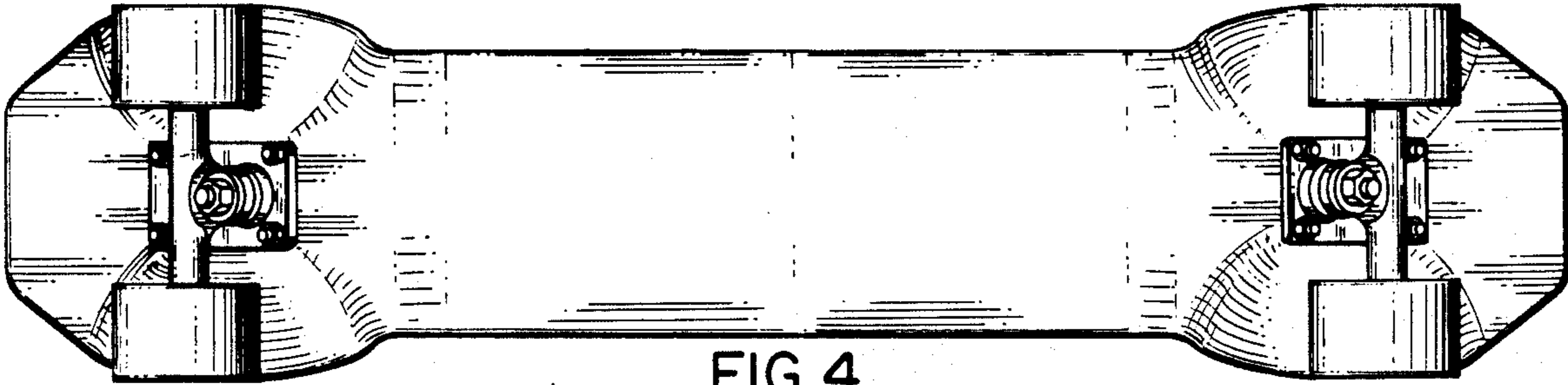

FIG. 4

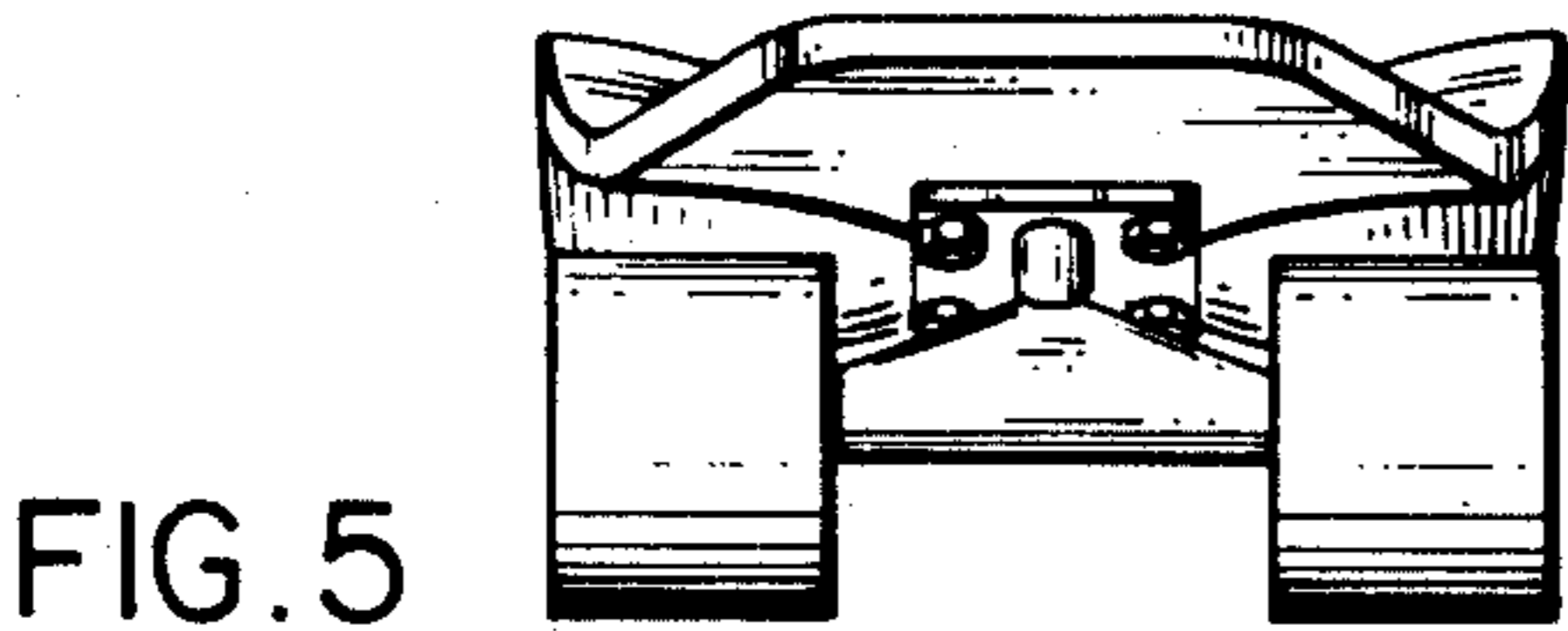

FIG. 5

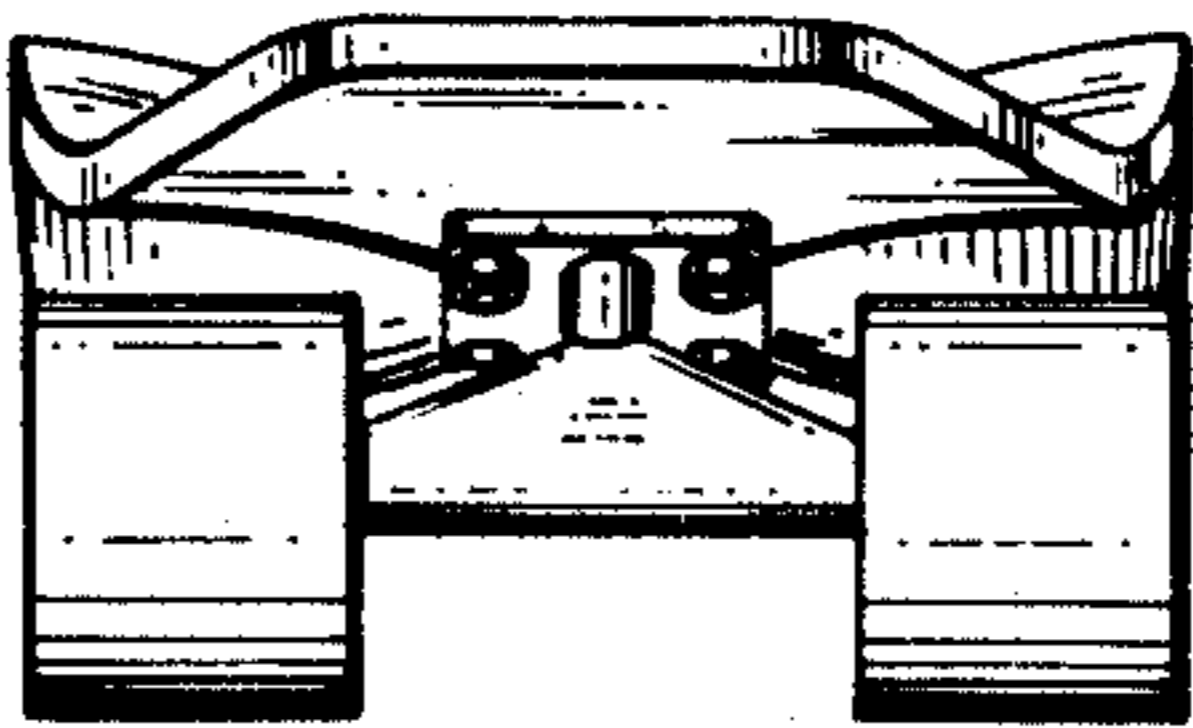

FIG. 6