

[54] KITCHEN FAUCET

[76] Inventor: Clifton D. Skinner, R.F.D. #1, Box 96, Dexter, Me. 04930

[\*\*] Term: 14 Years

[21] Appl. No.: 957,242

[22] Filed: Nov. 2, 1978

Related U.S. Application Data

[63] Continuation-in-part of Ser. No. 713,853, Aug. 11, 1976.

[51] Int. Cl. .... D23-01

[52] U.S. Cl. .... D23/23

[58] Field of Search .... D23/23-32, D23/14, 15, 16; 137/625.17

[56] References Cited

U.S. PATENT DOCUMENTS

D. 2,293	4/1866	Nichols .....	D23/14
D. 6,032	8/1872	Douglas .....	D23/14
D. 118,981	2/1940	Loeber .....	D23/14
D. 130,244	11/1941	Gerhardt .....	D23/14
D. 200,390	2/1965	Staat et al. ....	D23/23
D. 213,874	4/1969	Landel et al. ....	D23/23
D. 219,779	1/1971	Tiller .....	D23/23
3,012,582	12/1961	Russell .....	137/625.17
3,035,612	5/1962	Lyon .....	D23/23 X

Primary Examiner—James R. Largen  
Attorney, Agent, or Firm—Harris M. Isaacson

[57] CLAIM

The ornamental design for a kitchen faucet, as shown.

DESCRIPTION

FIG. 1 is a side elevation of a kitchen faucet showing my new design.

FIG. 2 is a front elevation thereof.

FIG. 3 is a rear elevation thereof.

FIG. 4 is a top plan thereof.

FIG. 5 is a bottom plan thereof.

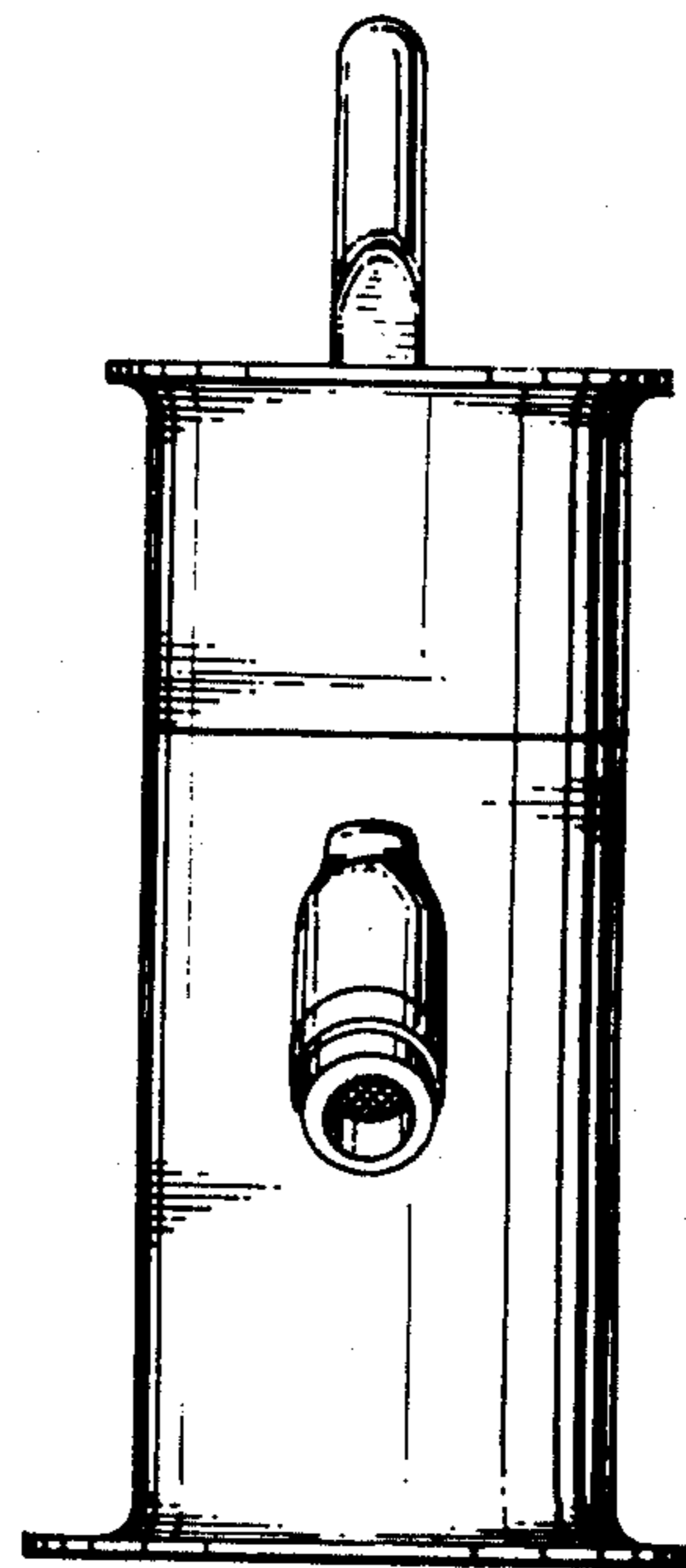
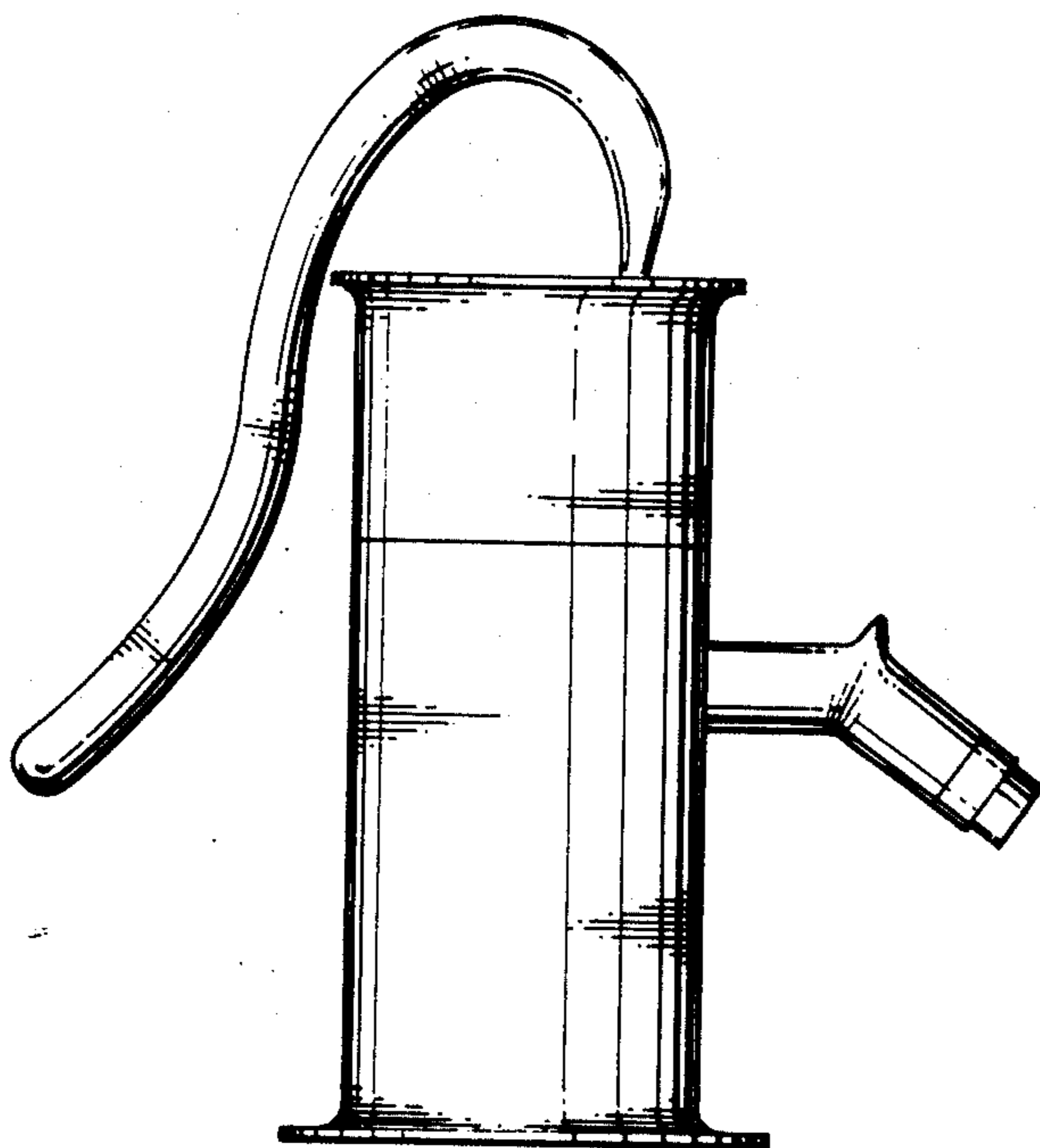

FIG. 1

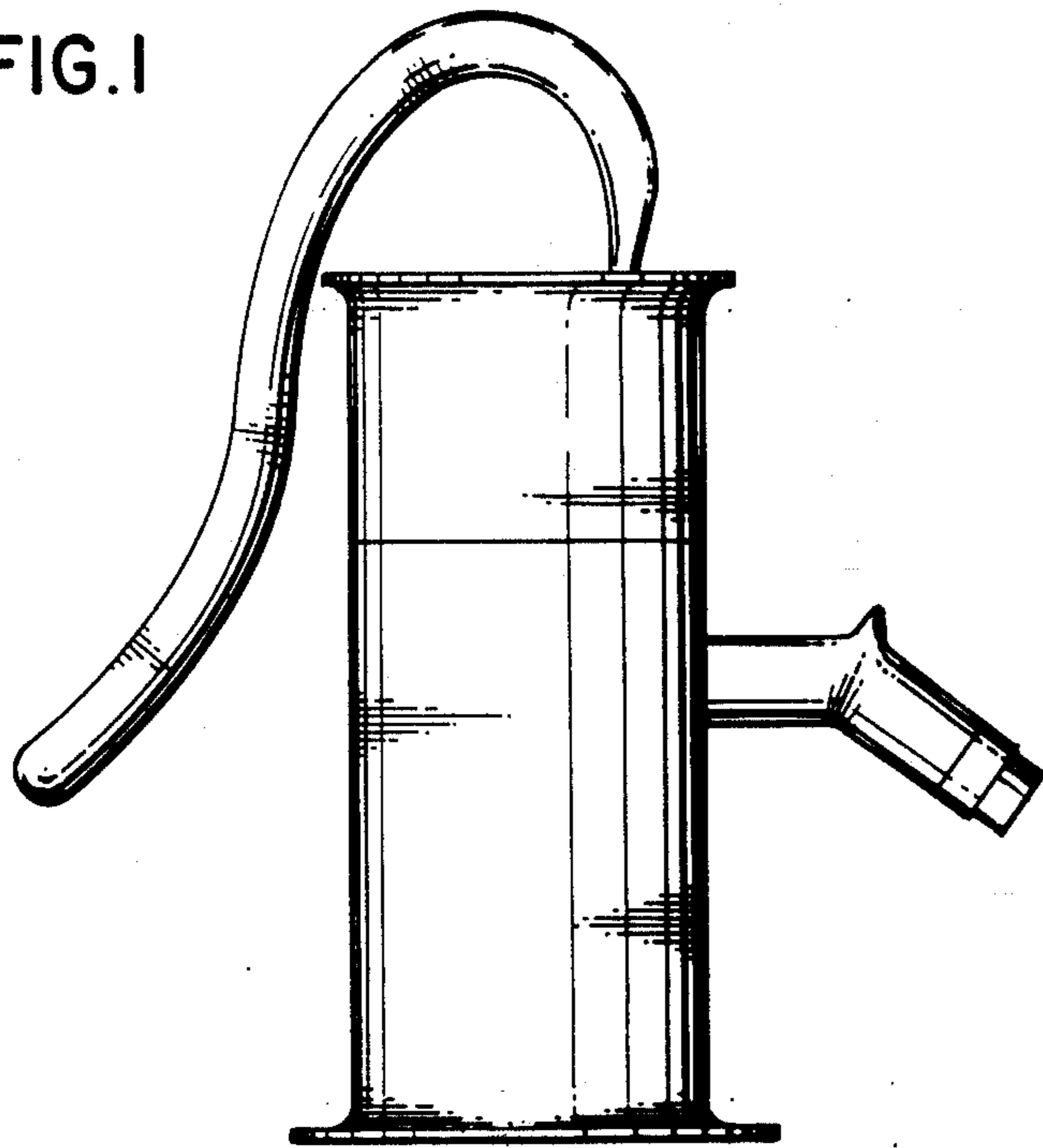

FIG. 2

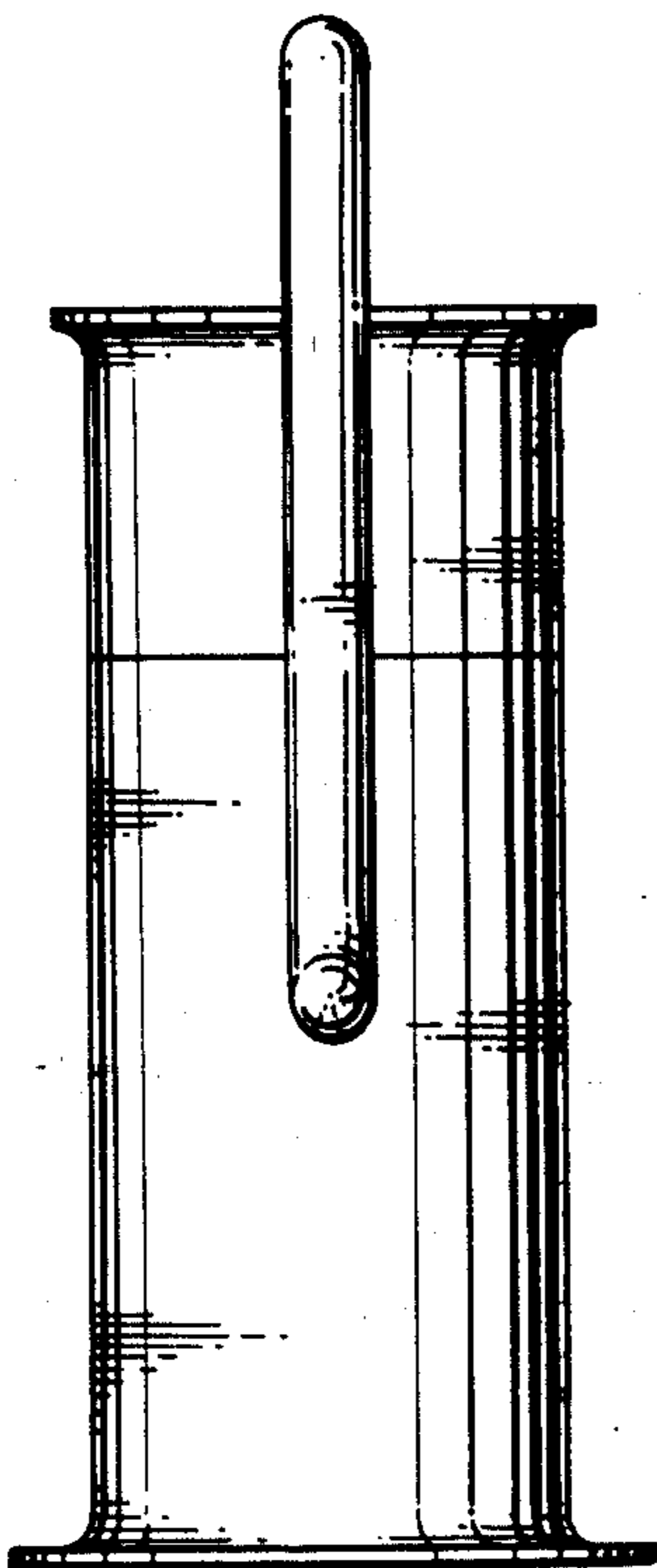
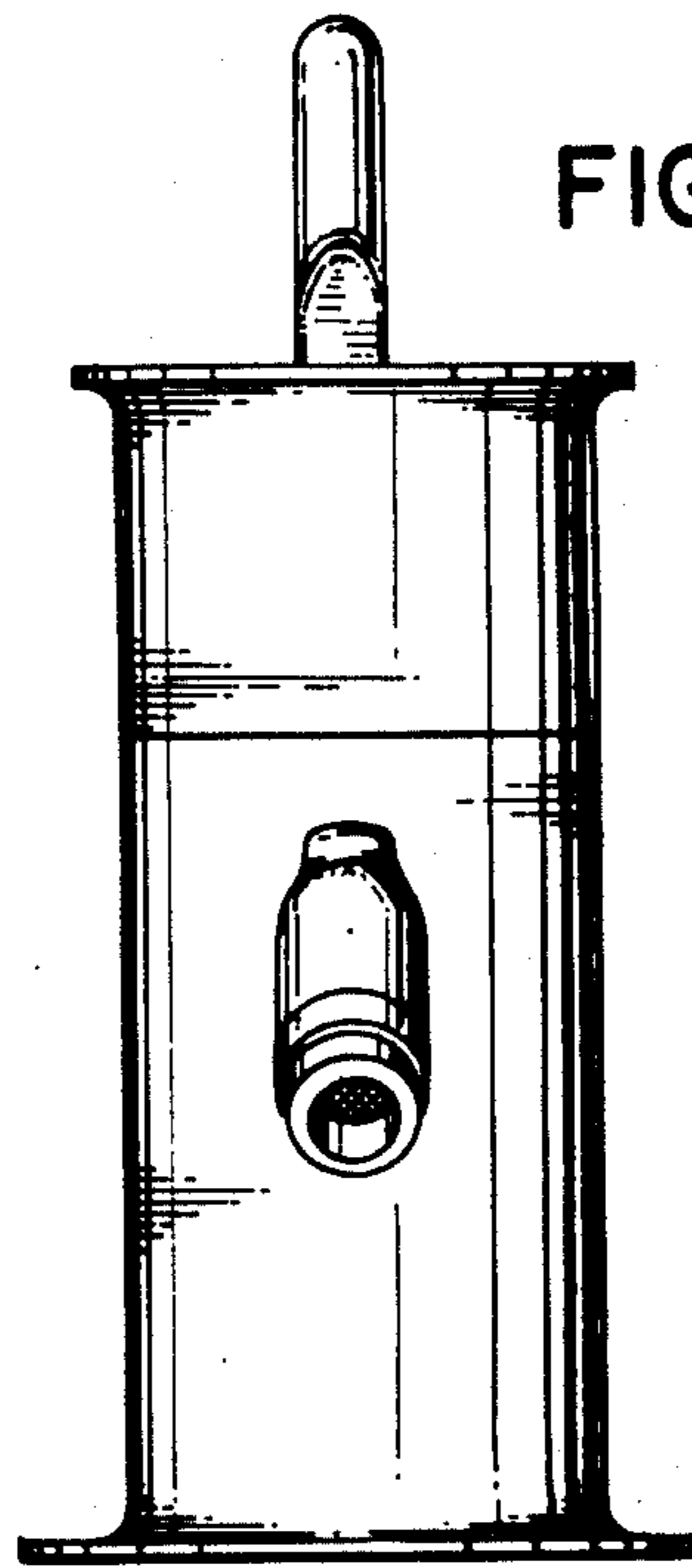

FIG. 3

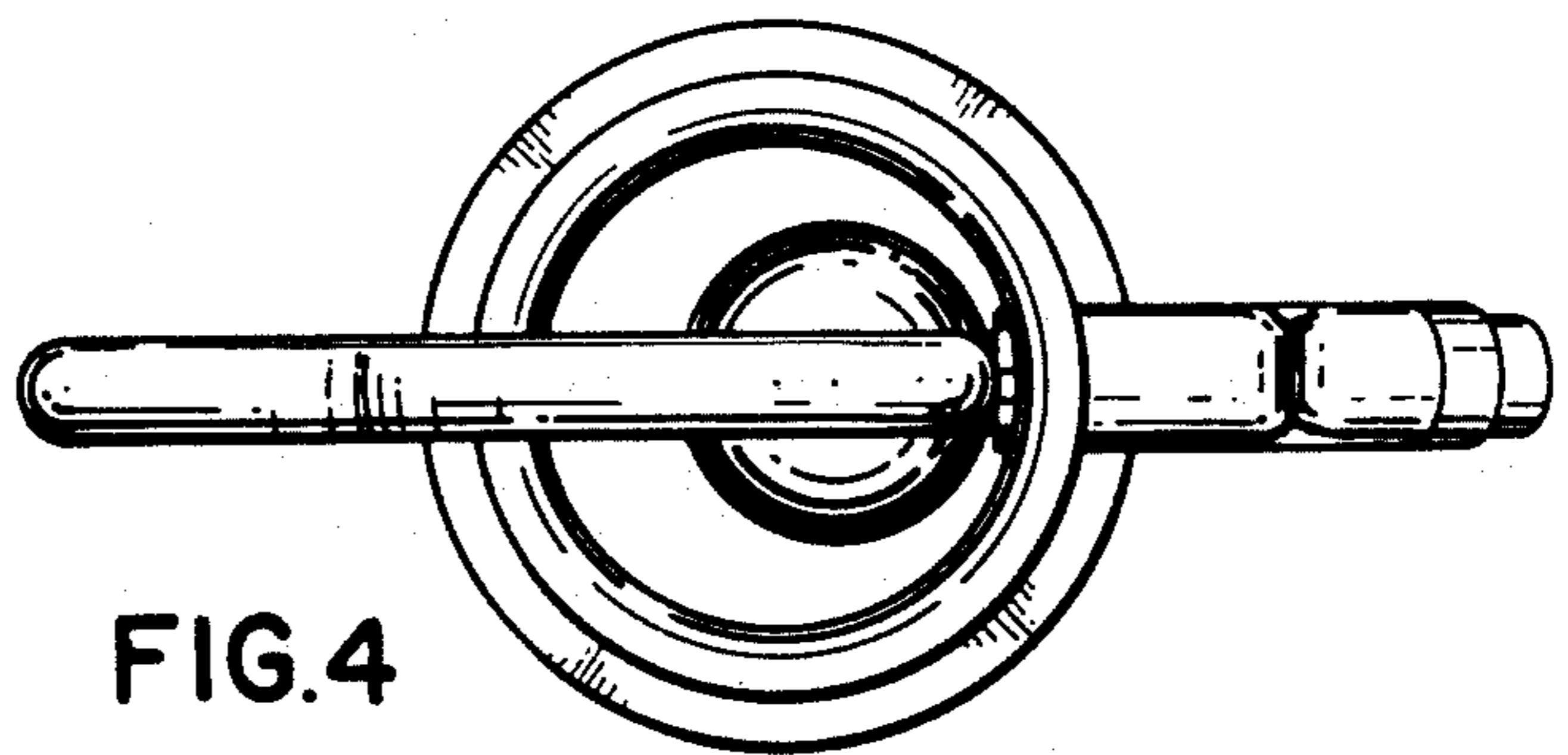

FIG. 4

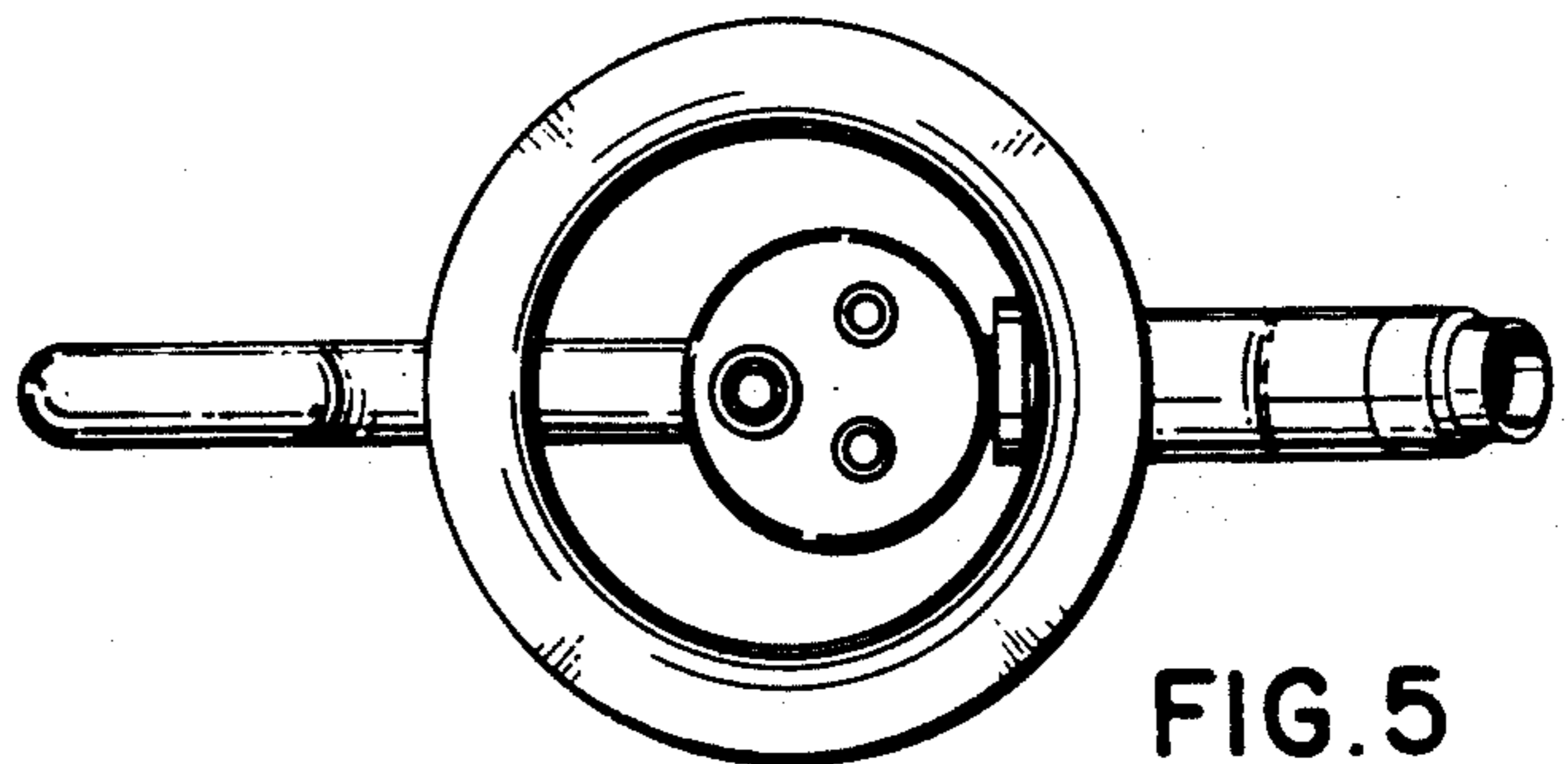

FIG. 5