

[54] CHLORINATOR FOR SWIMMING POOLS

2,976,129 3/1961 Buehler 422/265

[76] Inventor: James M. Hehnen, 3881 W. 160th St., Cleveland, Ohio 44111

OTHER PUBLICATIONS

Field & Stream, Sep. 1959, p. 78, bottom left item.

[**] Term: 14 Years

Primary Examiner—James R. Largen
Attorney, Agent, or Firm—Robert J. Fay

[21] Appl. No.: 819,070

[57] CLAIM

[22] Filed: Jul. 26, 1977

The ornamental design for a chlorinator for swimming pools, as shown.

[51] Int. Cl. D23—01

[52] U.S. Cl. D23/3

[58] Field of Search D23/1-4;
D22/21; 422/263-266

DESCRIPTION

FIG. 1 is a top plan view of a chlorinator for swimming pools showing my new design;

FIG. 2 is a right side view thereof;

FIG. 3 is a rear elevational view thereof;

FIG. 4 is a front elevational view thereof;

FIG. 5 is a left side view thereof;

FIG. 6 is a bottom view thereof; and

FIG. 7 is a cross sectional view taken on line 7—7 of FIG. 1.

[56] References Cited

U.S. PATENT DOCUMENTS

D. 148,507	1/1948	Williams	D22/21
D. 148,508	1/1948	Williams	D22/21
D. 165,754	1/1952	Herter	D22/21
D. 229,306	11/1973	McGraw	D22/21

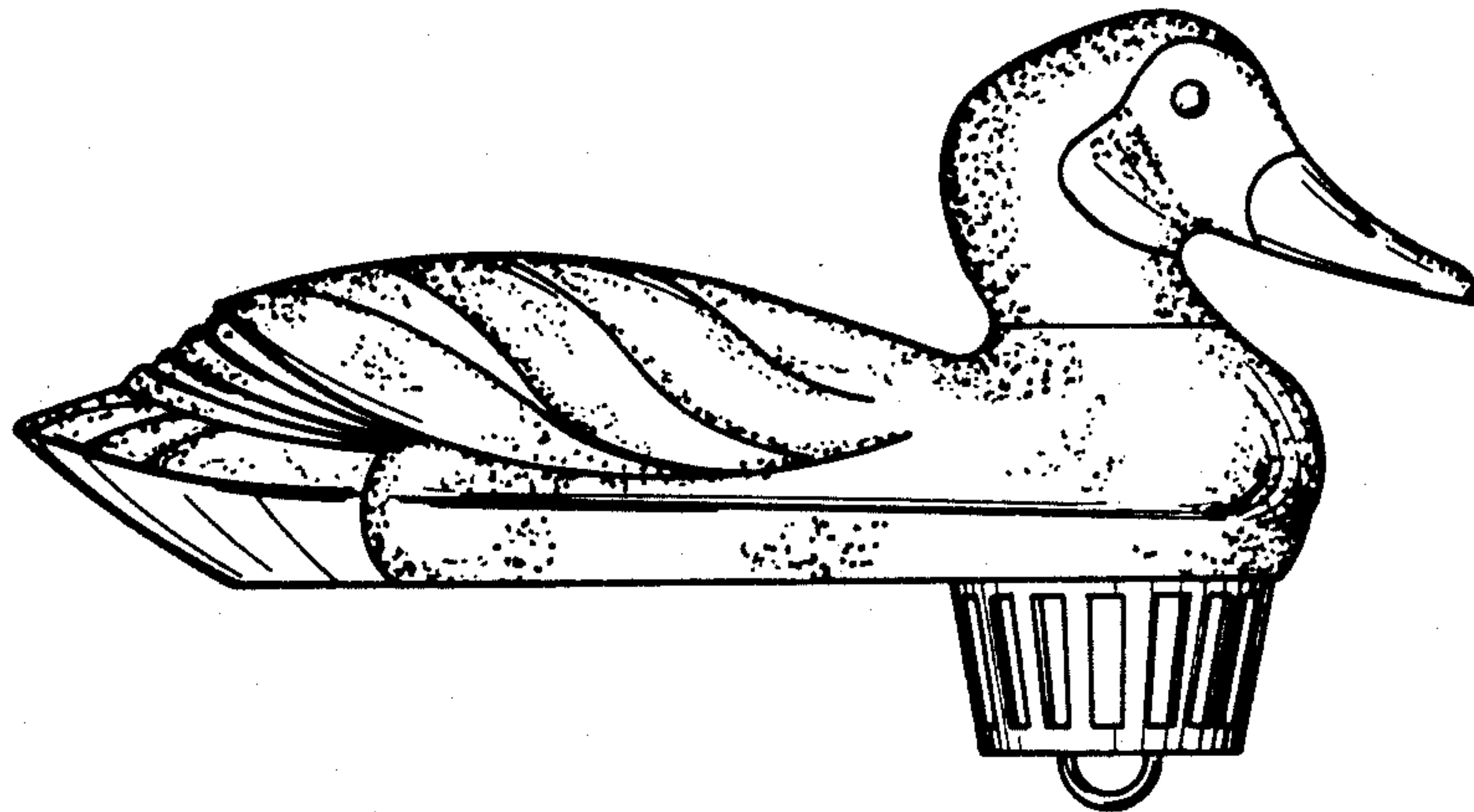
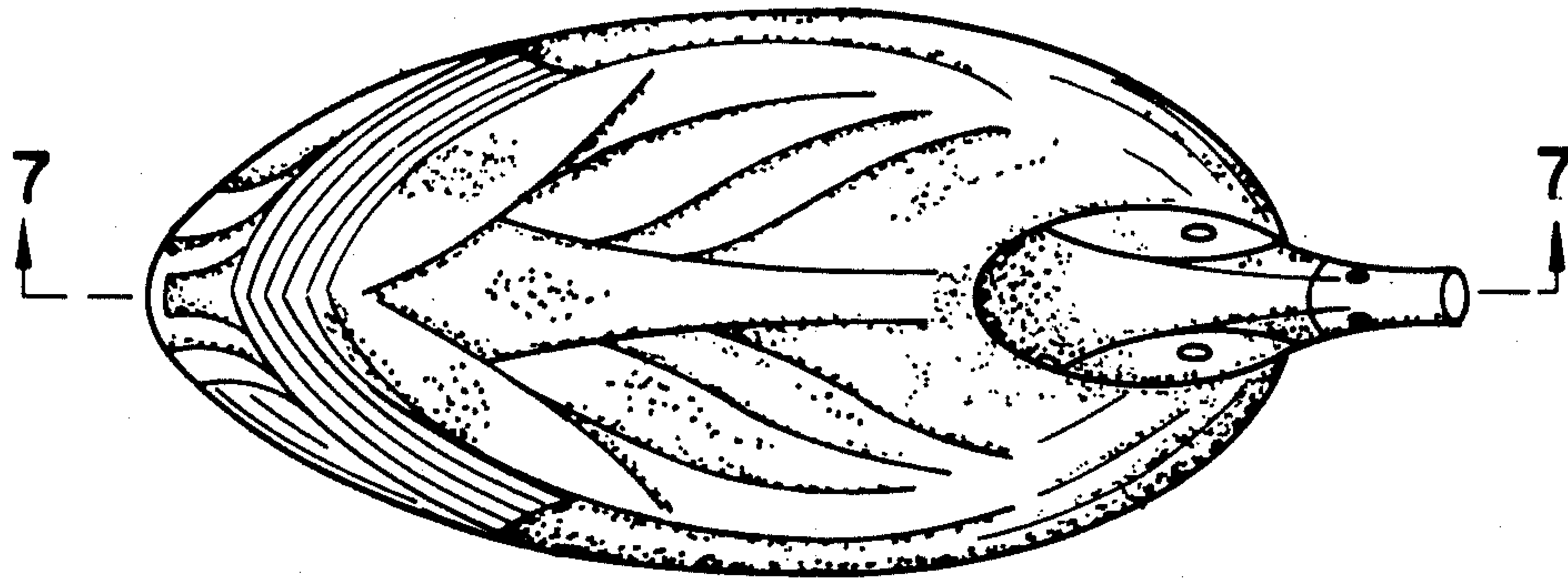

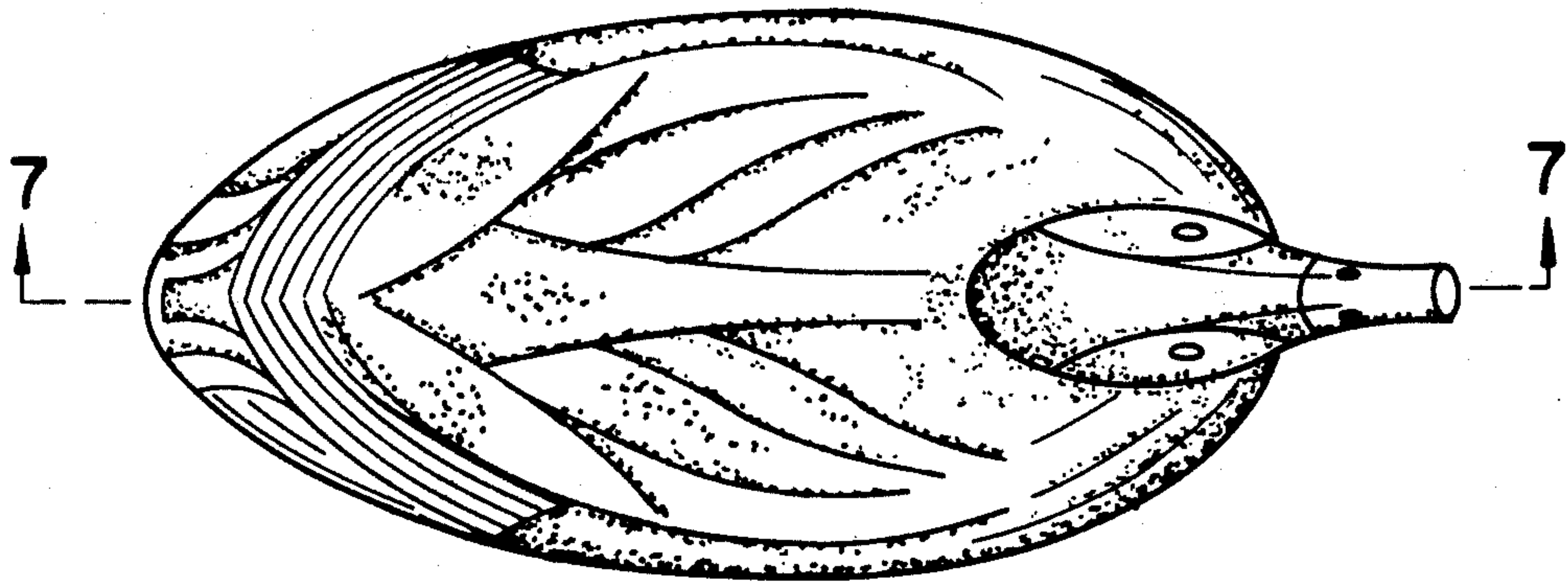

FIG. 1

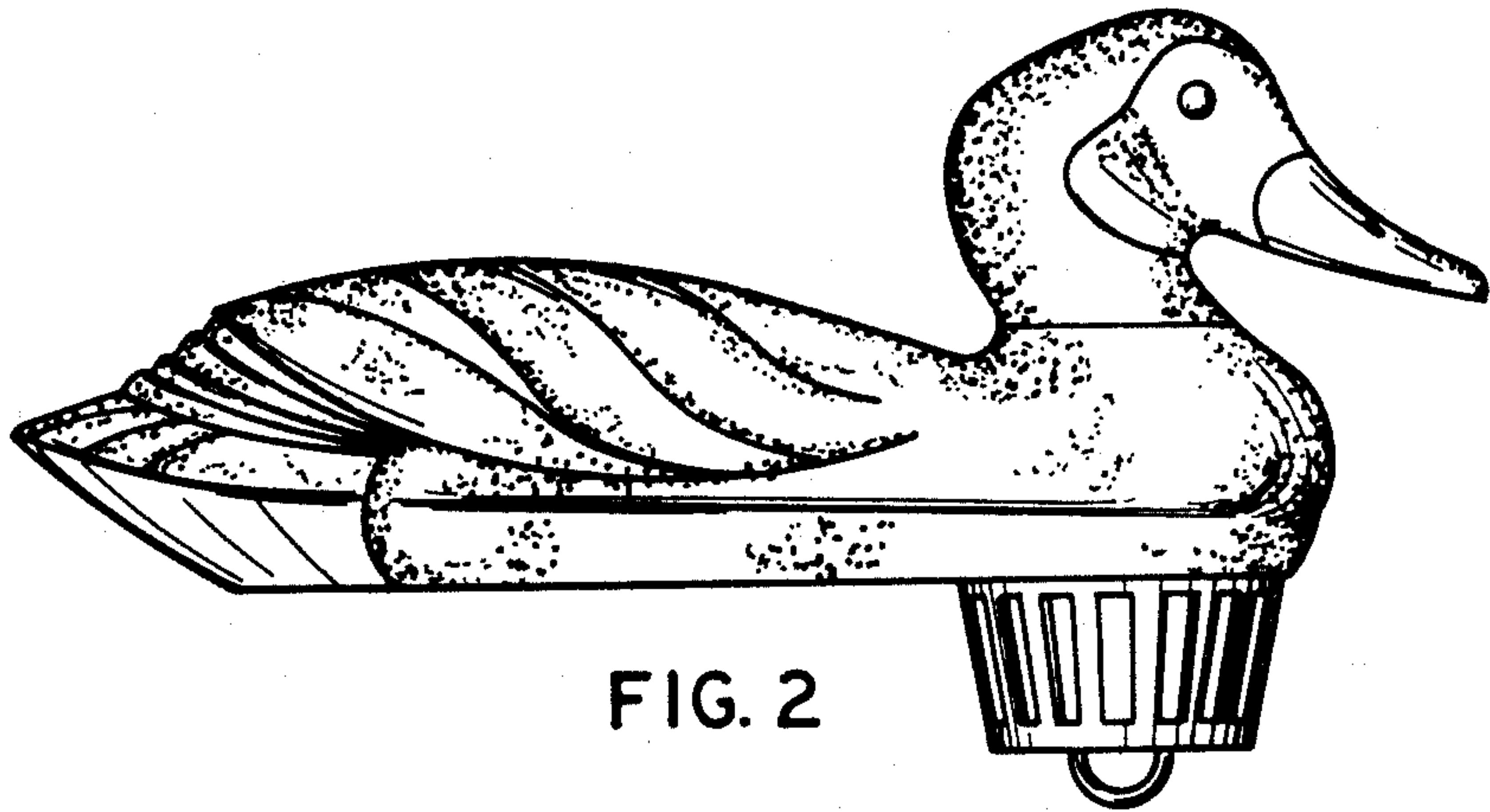

FIG. 2

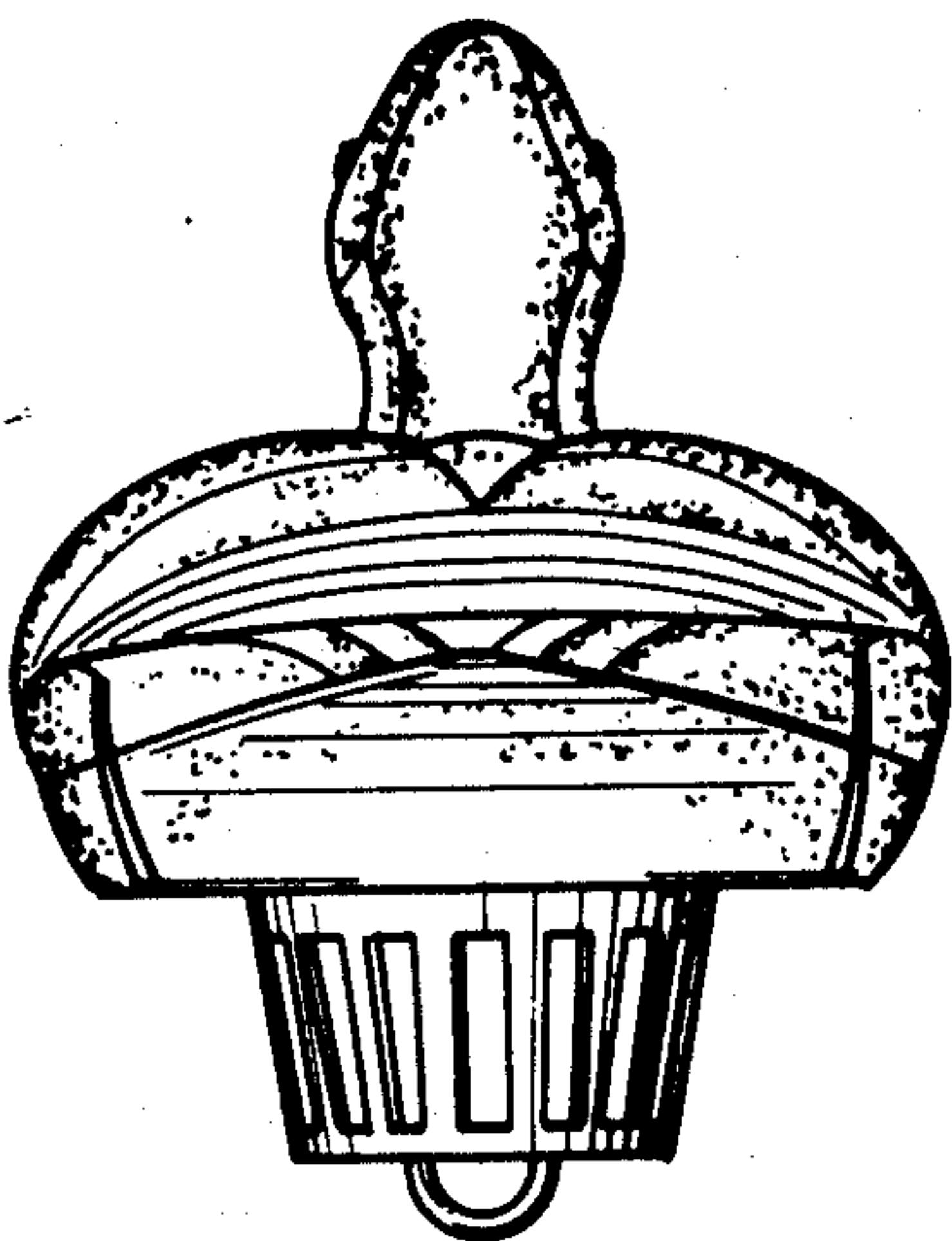

FIG. 3

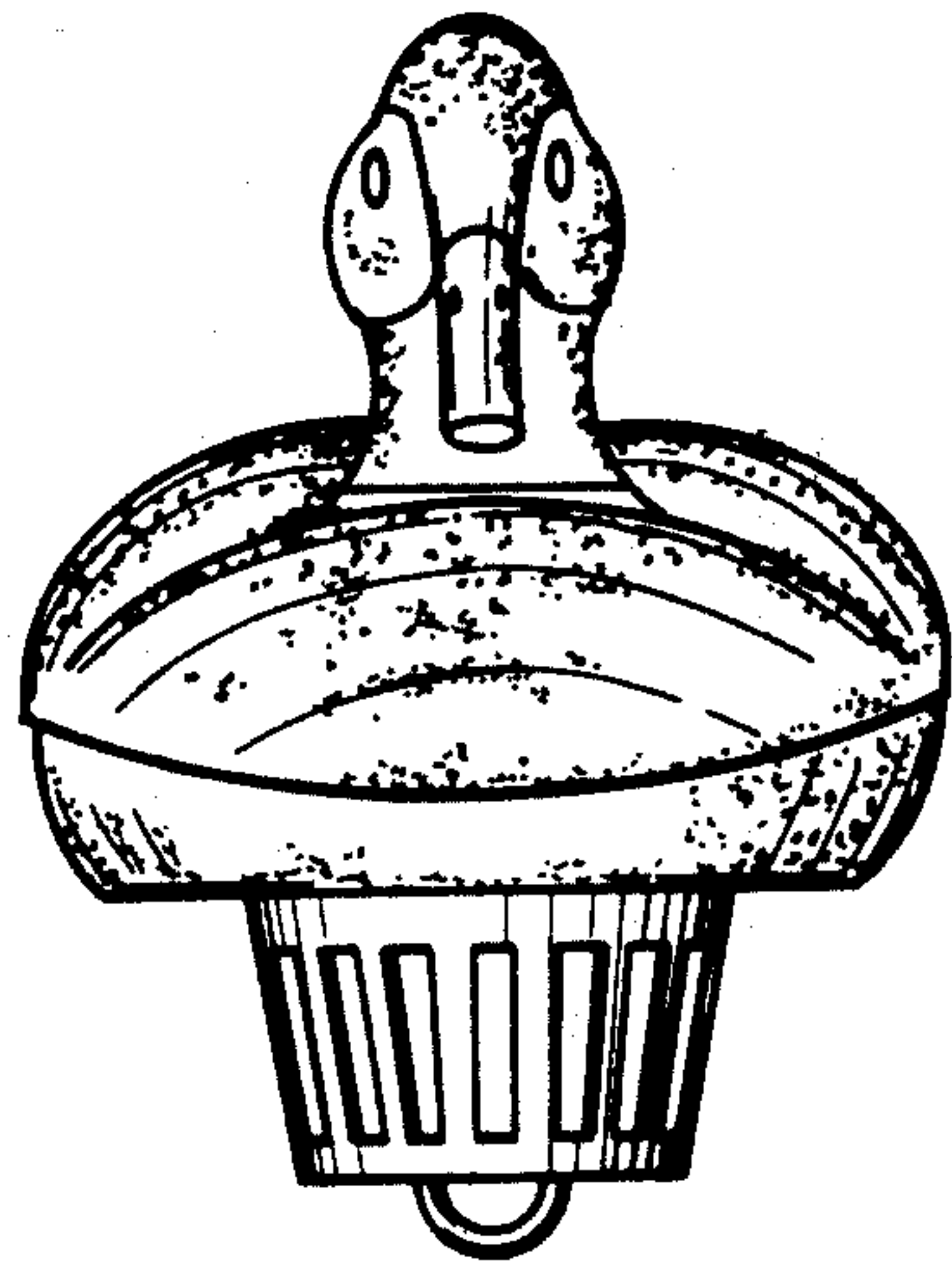

FIG. 4

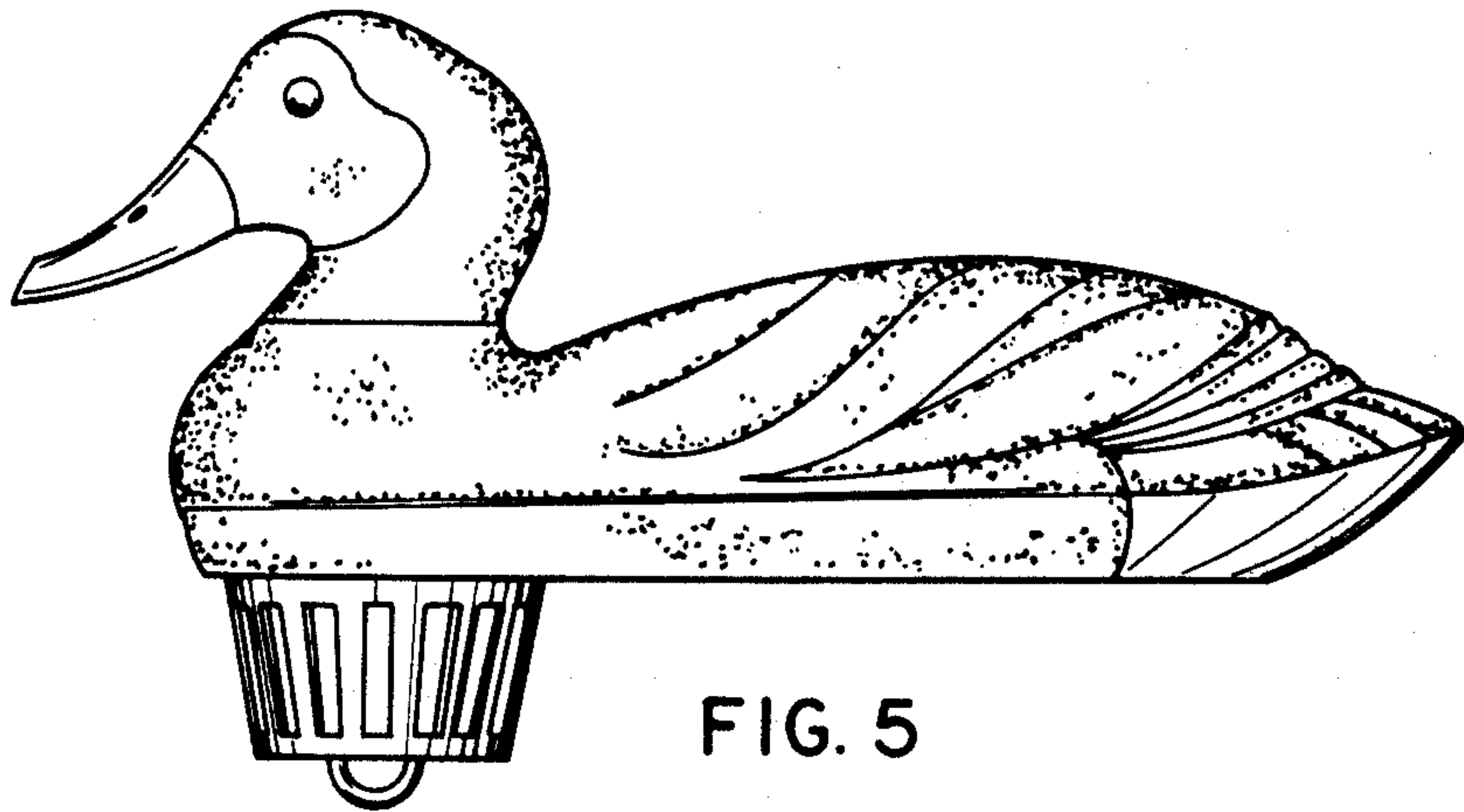

FIG. 5

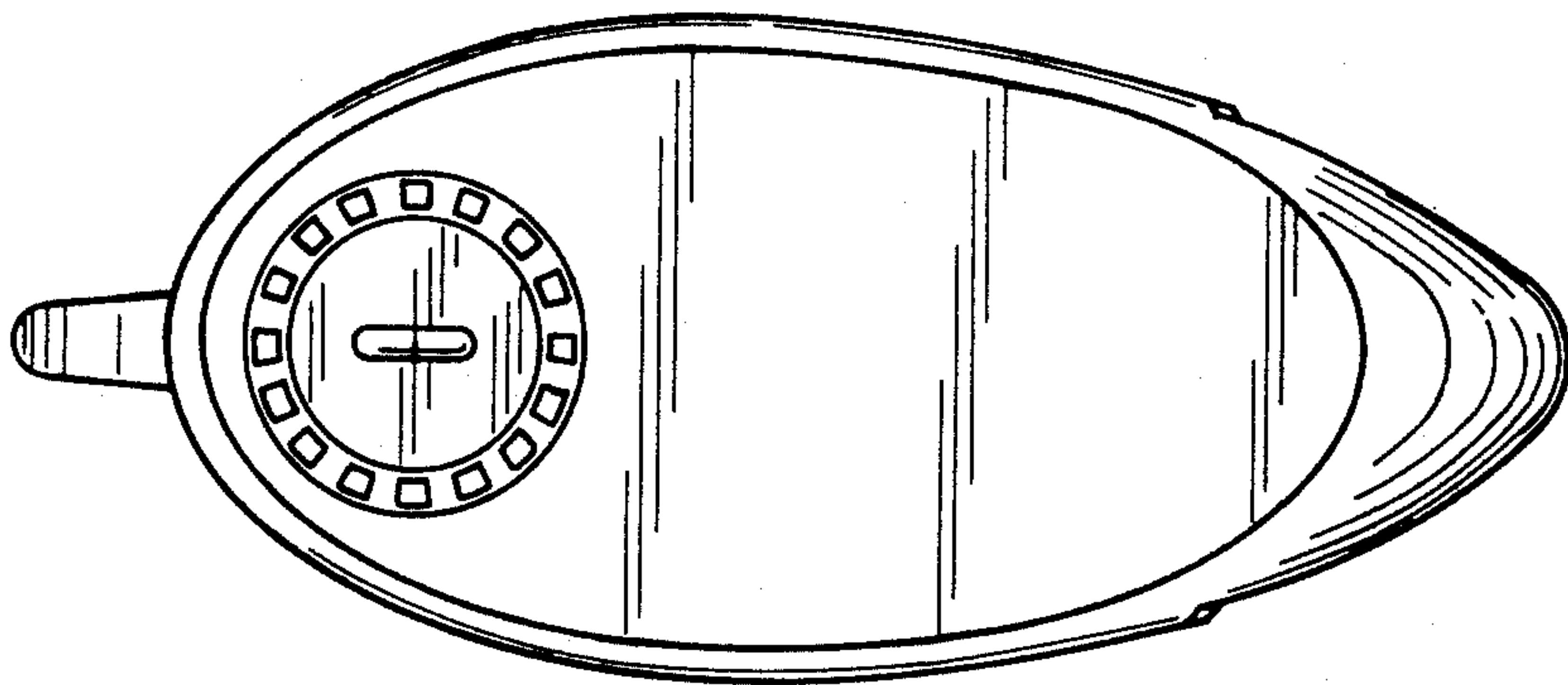

FIG. 6

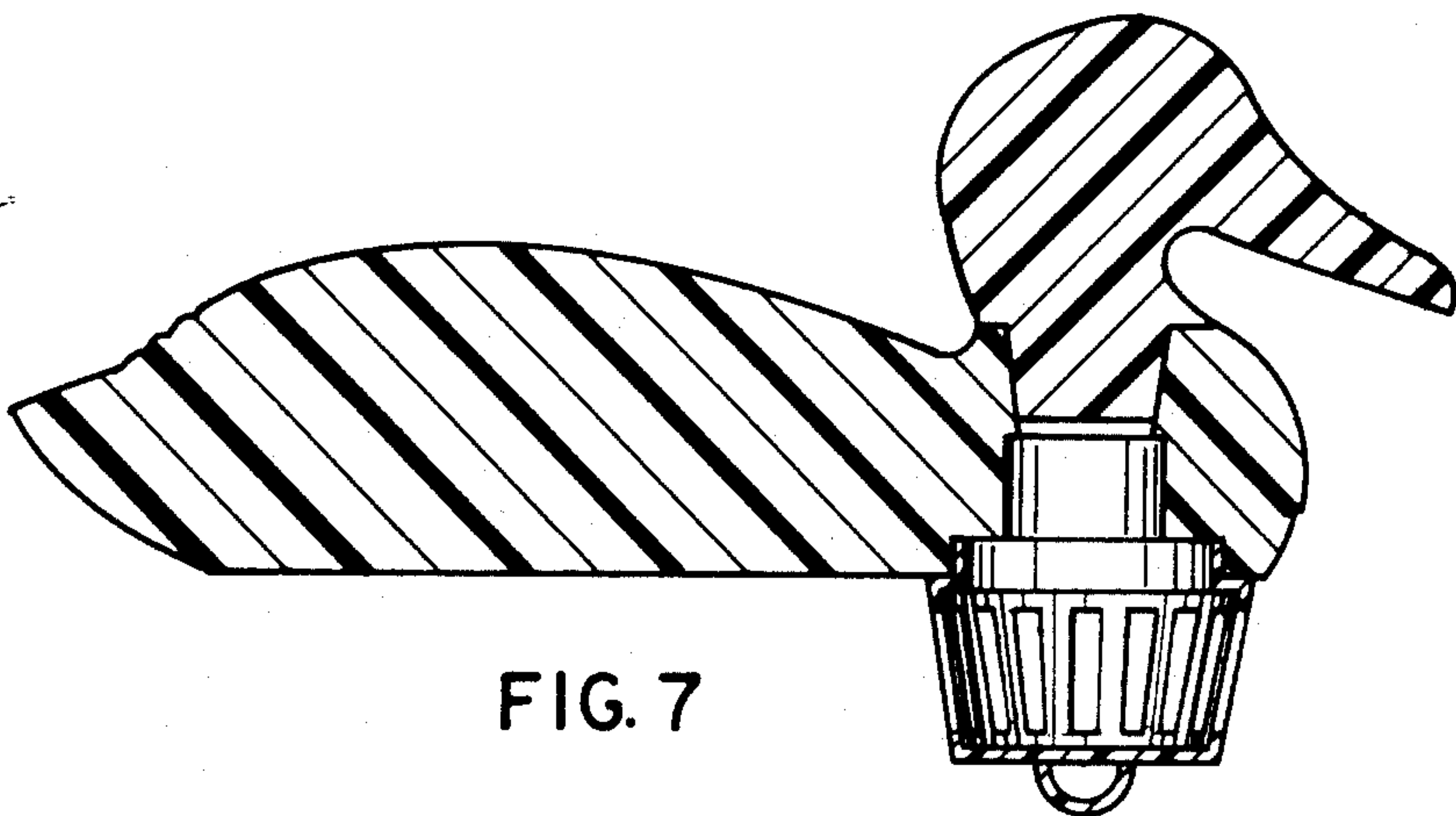

FIG. 7