

[54] TRASH CART OR THE LIKE

3,191,960 6/1965 Turner D12/27
4,017,092 4/1977 Boomer 280/47.26

[76] Inventor: Jerry N. Gardner, 3149 Stratton Rd.,
Jacksonville, Fla. 32221

Primary Examiner—James M. Gandy
Attorney, Agent, or Firm—George H. Baldwin

[**] Term: 14 Years

[57] CLAIM

[21] Appl. No.: 897,525

The ornamental design for a trash cart or the like, sub-
stantially as shown.

[22] Filed: Apr. 17, 1978

DESCRIPTION

[51] Int. Cl. D12—02

[52] U.S. Cl. D12/33

[58] Field of Search D12/33, 27;
280/47.13 R, 47.17, 47.19, 47.24, 47.26, 47.34,
47.35, 79.1 R, 79.1 A, 79.2, 79.3; 248/98, 99, 97,
129, 128

FIG. 1 is a top plan view of the trash cart or the like
showing my new design;
FIG. 2 is a right end elevational view thereof;
FIG. 3 is a left side elevational view thereof;
FIG. 4 is a bottom plan view thereof;
FIG. 5 is a left end elevational view thereof;
FIG. 6 is a right side elevational view thereof;
FIG. 7 is a top plan view thereof with the hinged top in
opened condition; and
FIG. 8 is a right end elevational view of FIG. 7.

[56] References Cited

U.S. PATENT DOCUMENTS

D. 240,614 7/1976 Paterno D12/33

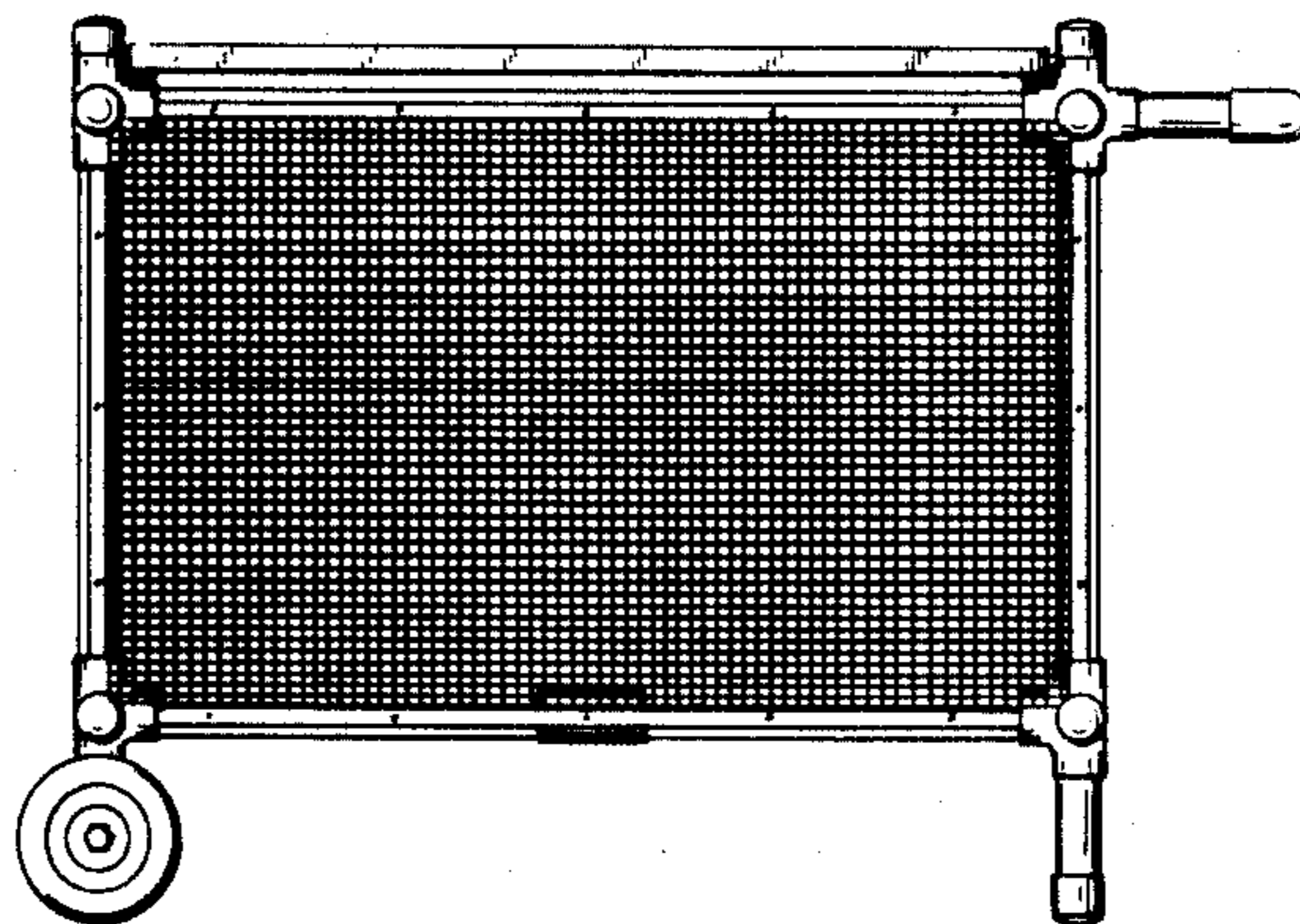
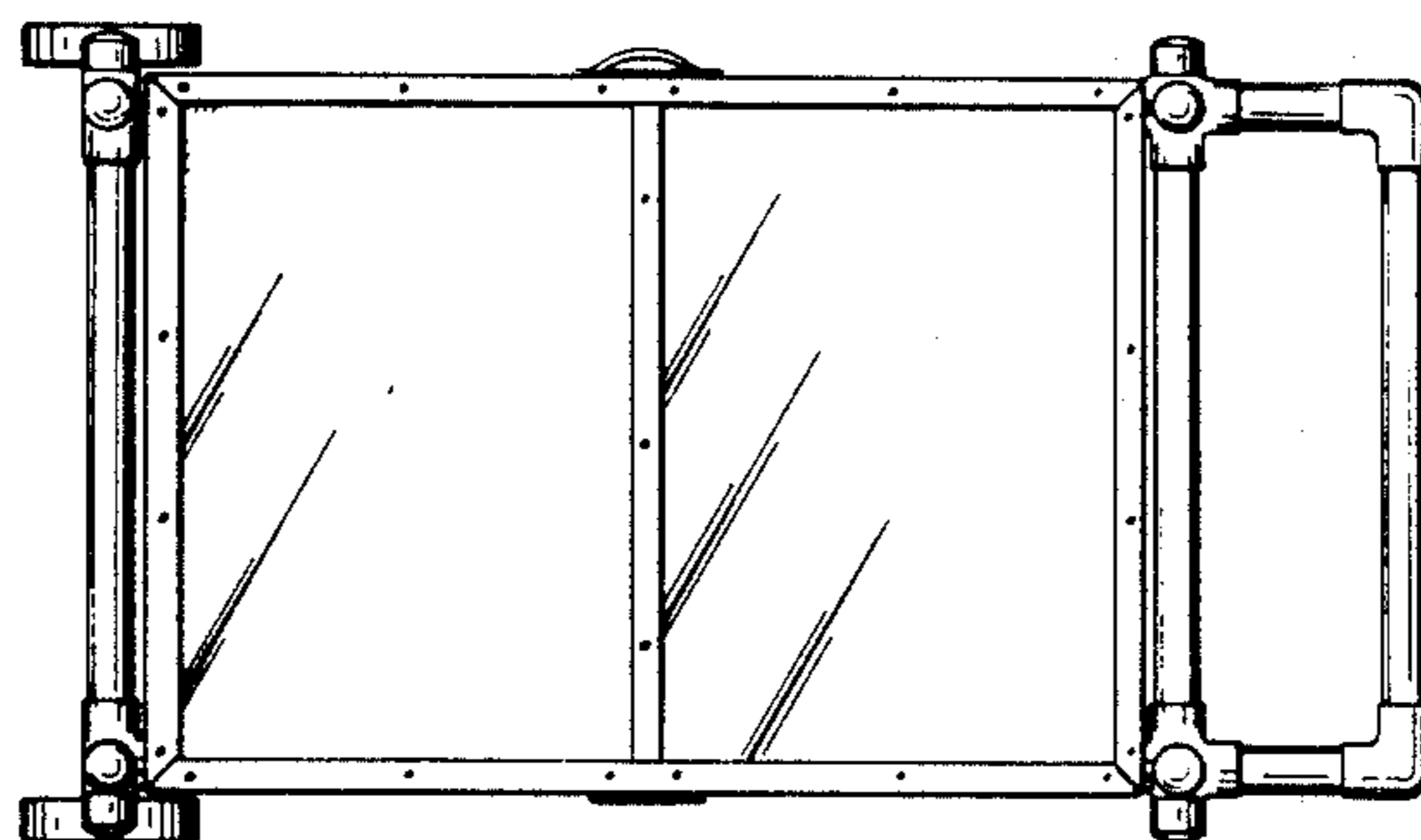

FIG. 1

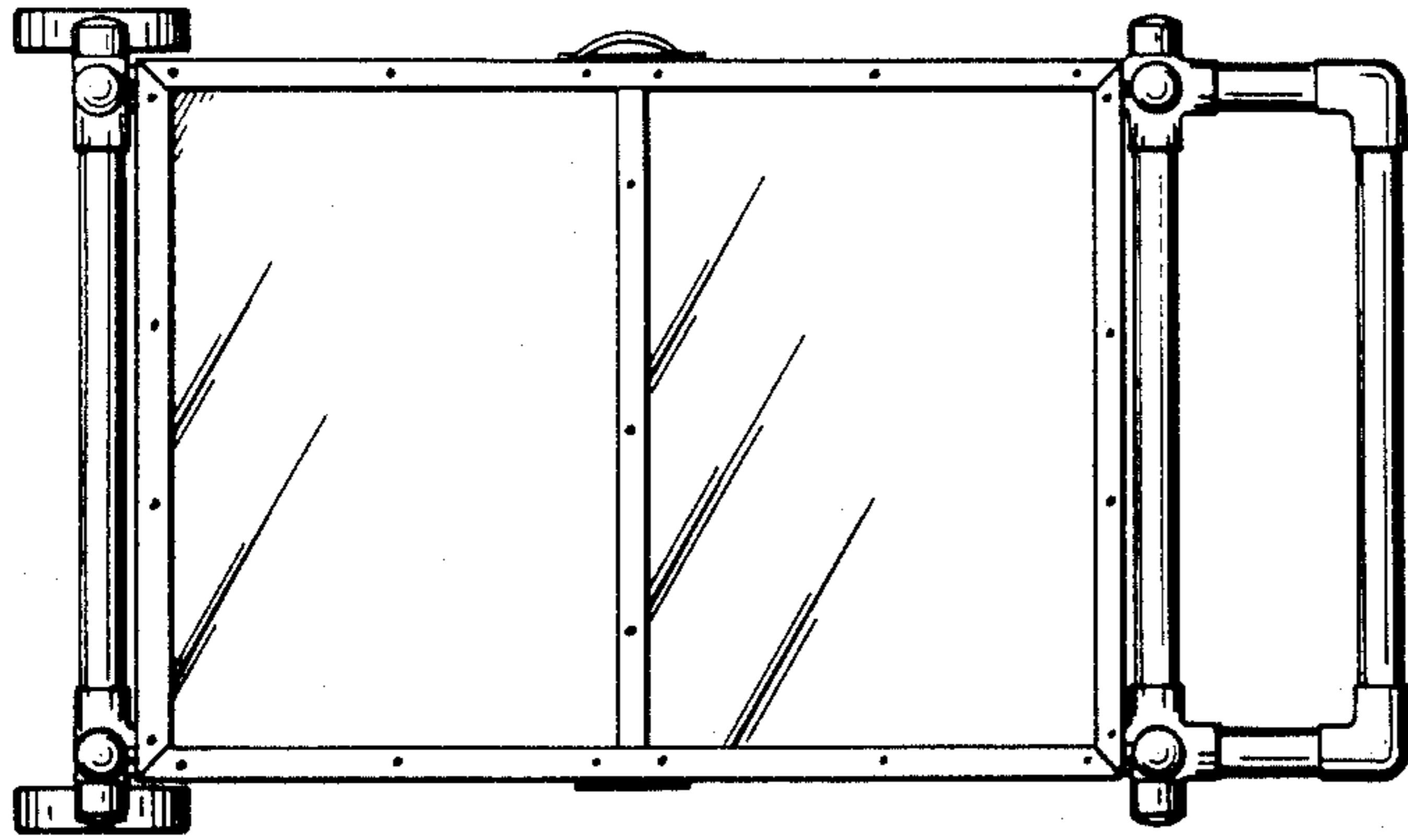

FIG. 2

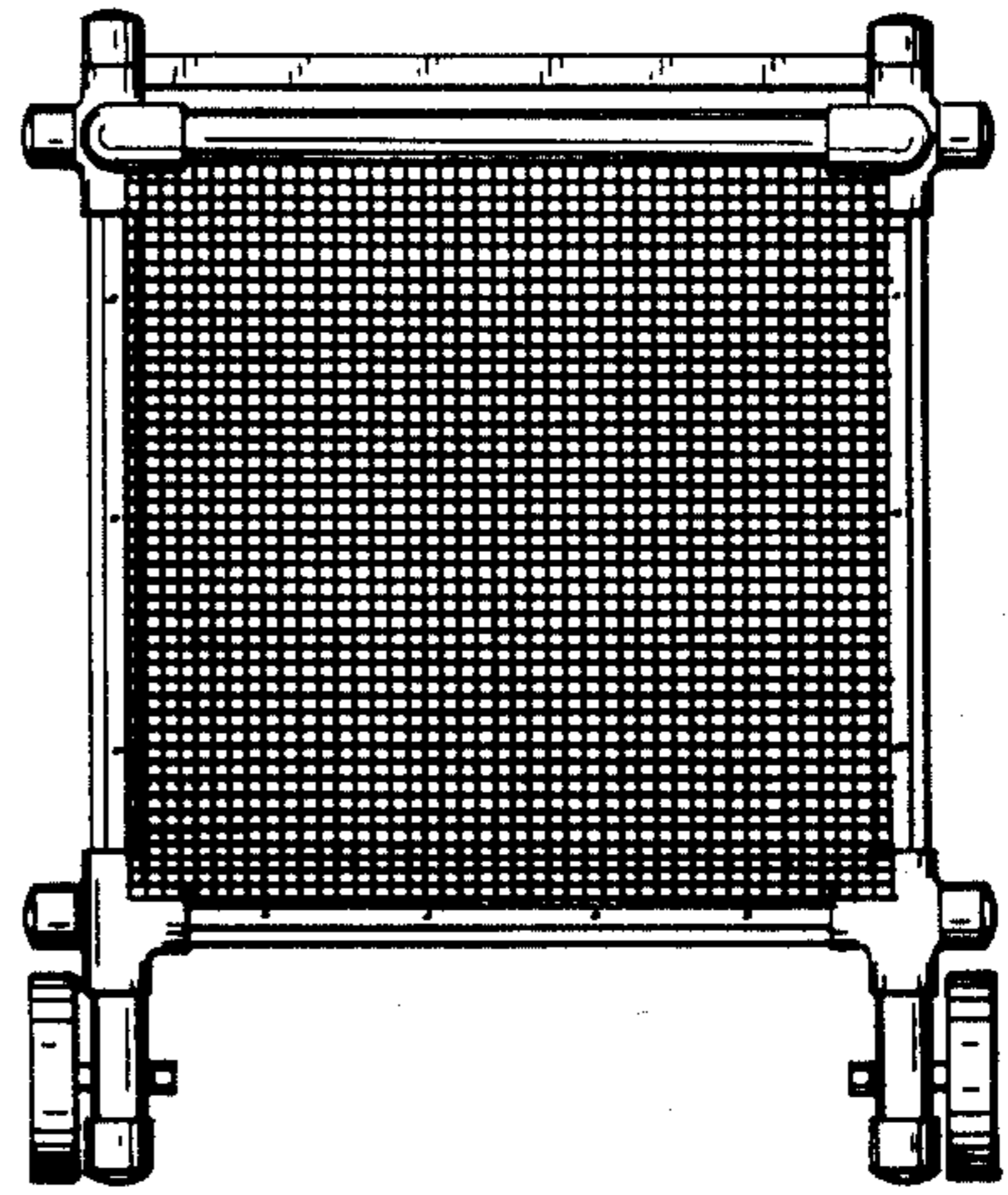

FIG. 3

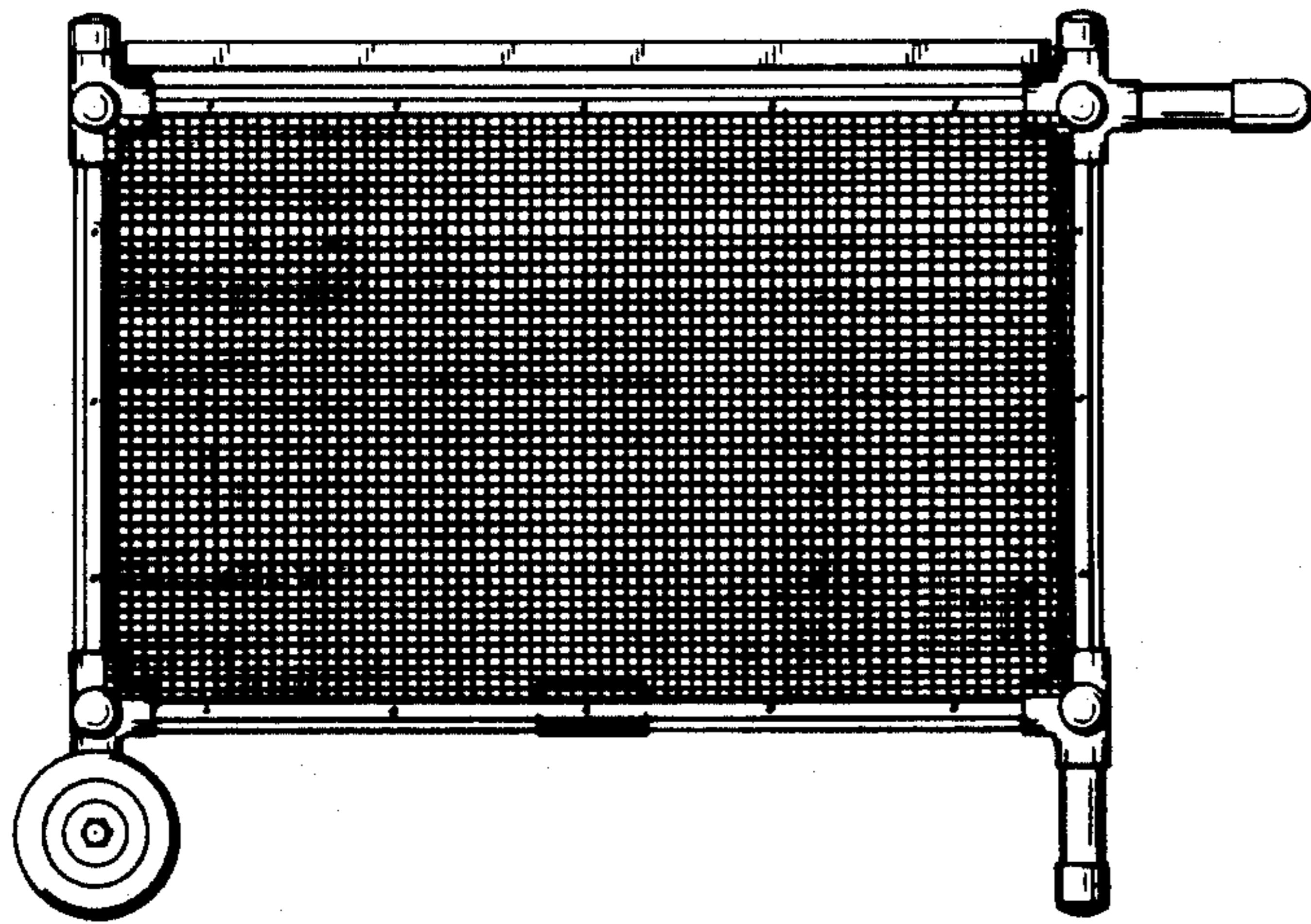

FIG. 5

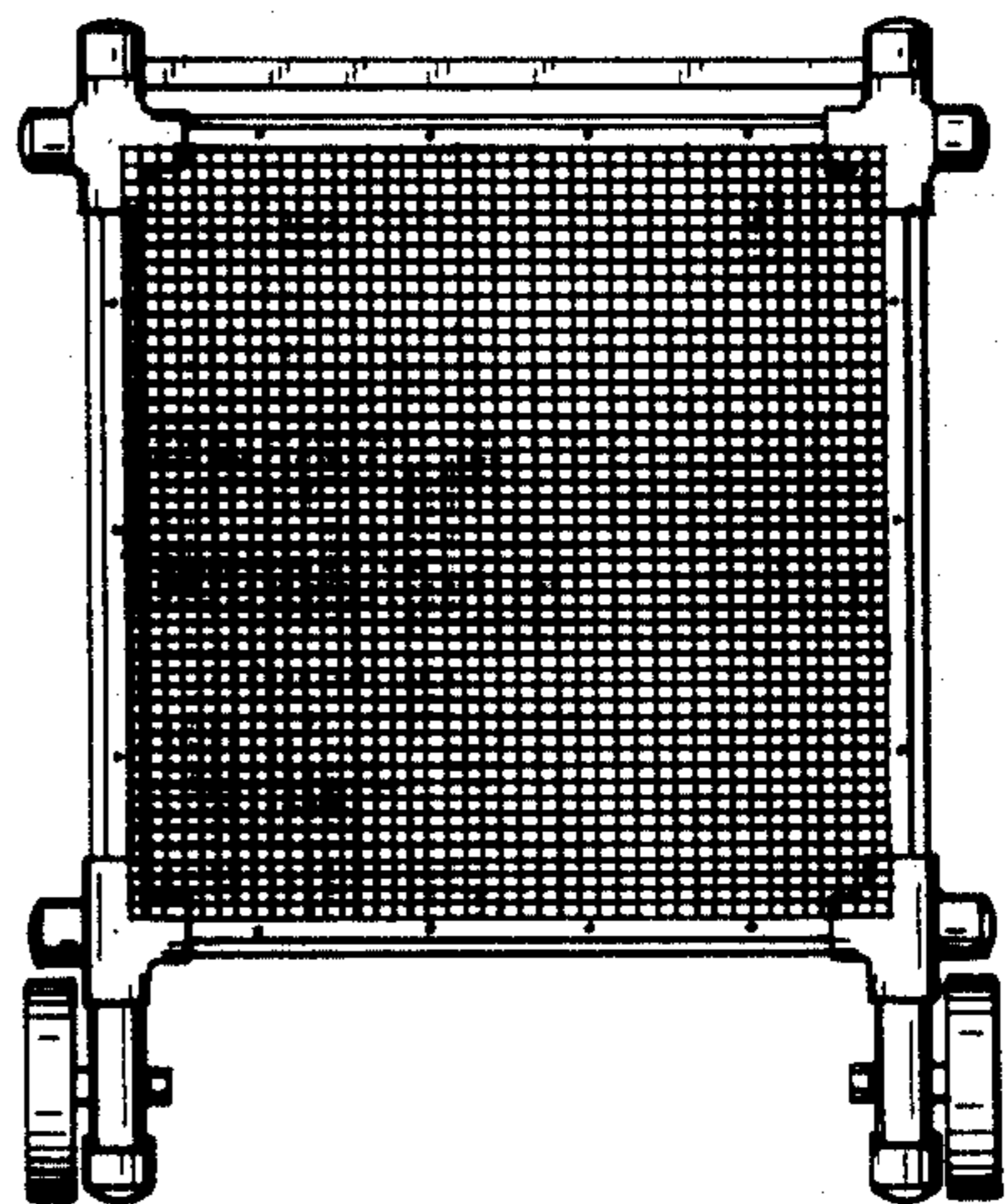

FIG. 4

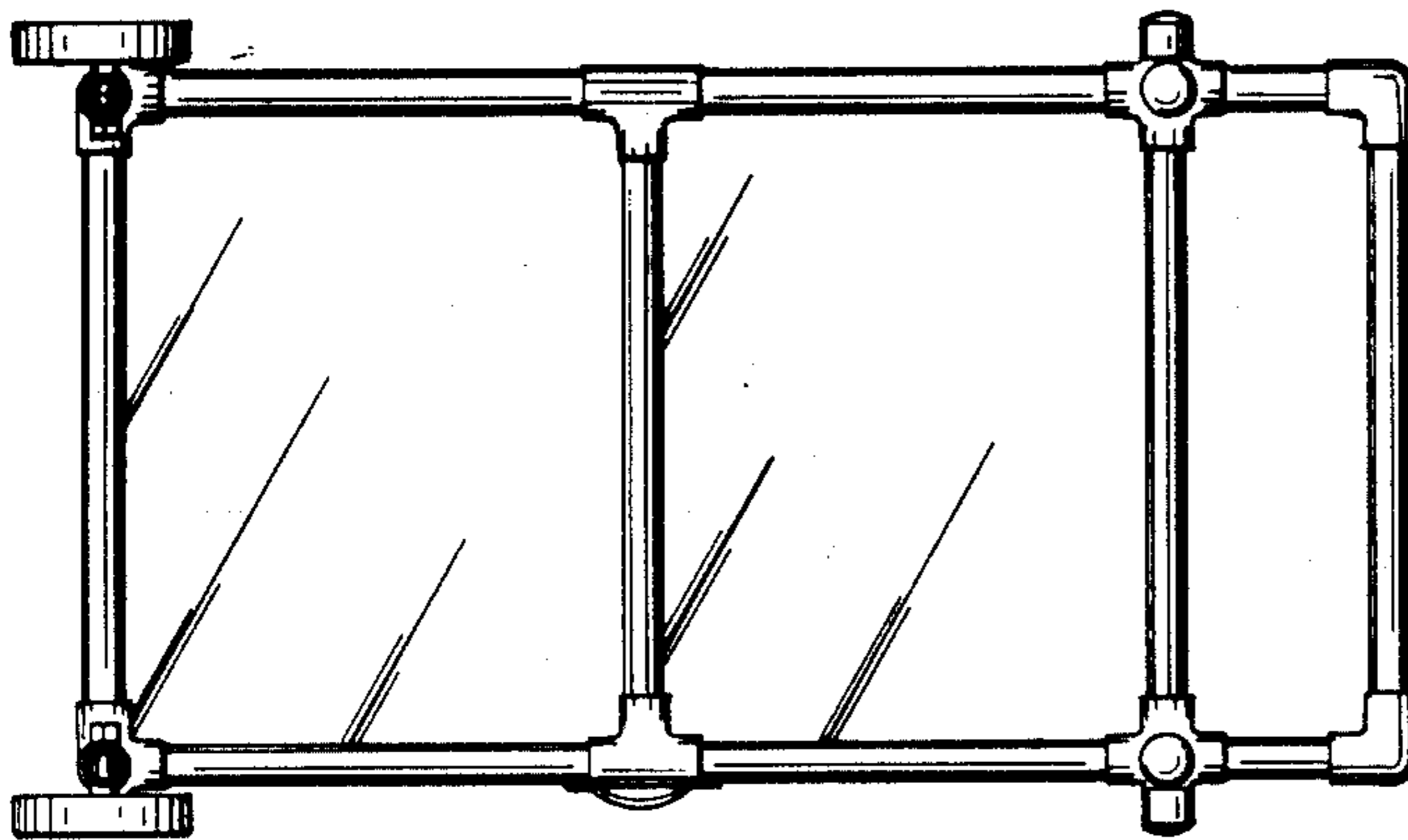

FIG. 7

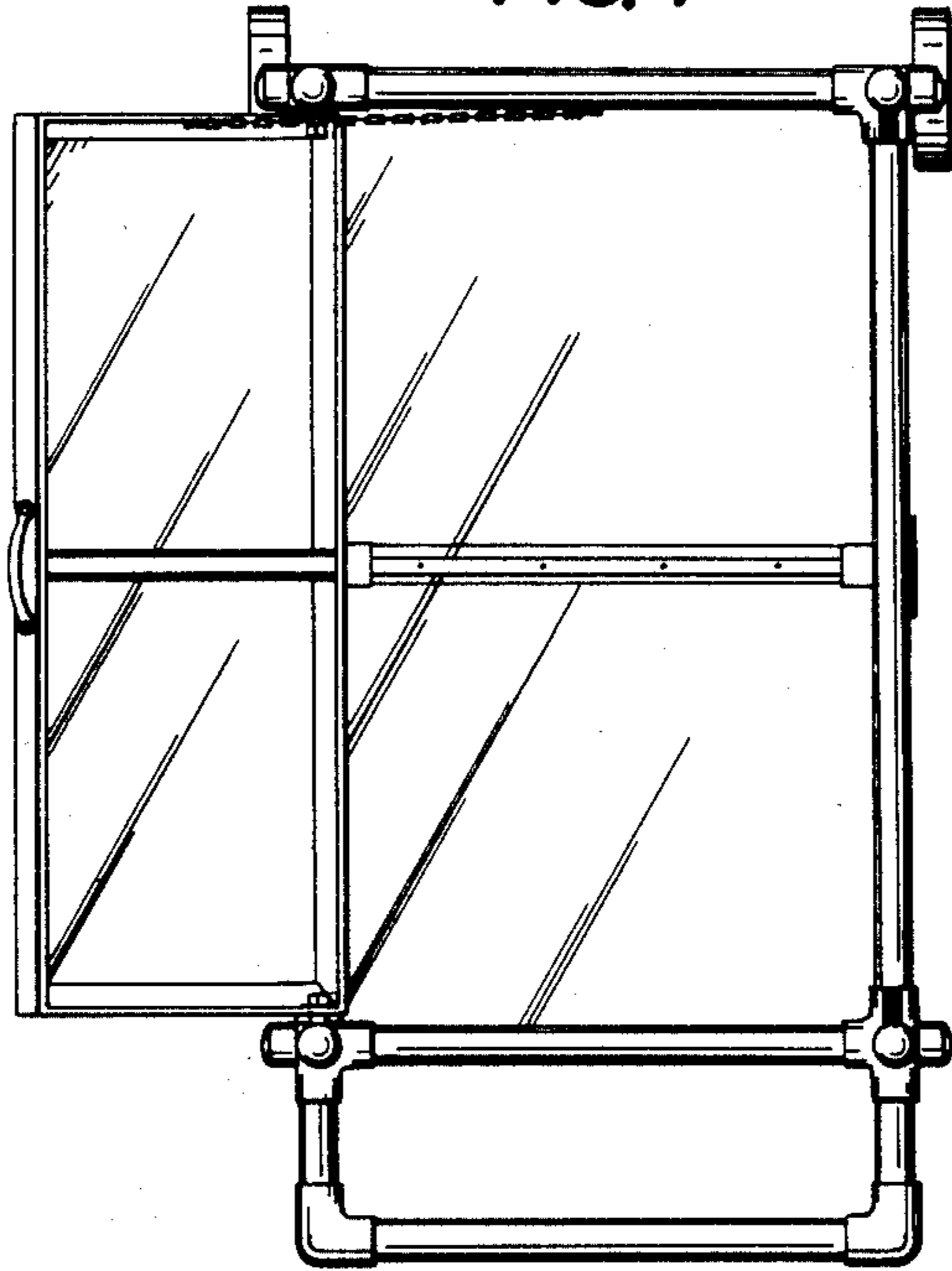

FIG. 6

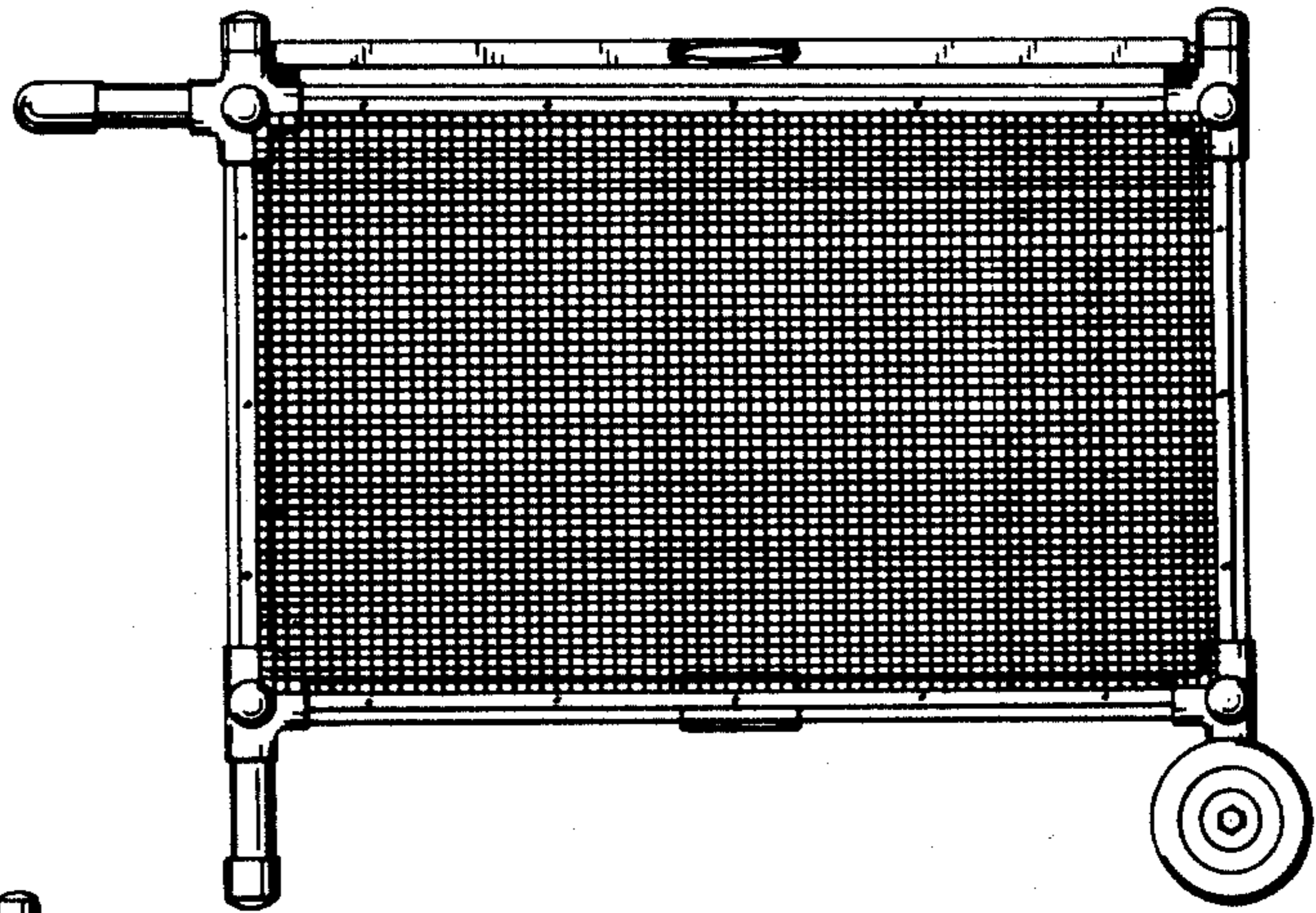

FIG. 8

