

[54] COMBINED GUN AND ACCESSORY CABINET OR SIMILAR ARTICLE

[75] Inventors: Ervin C. Oakley; George R. Bell; William E. Poole, all of Winston Salem, N.C.

[73] Assignee: ECO Industries, Inc.

[\*\*] Term: 14 Years

[21] Appl. No.: 798,911

[22] Filed: May 20, 1977

[51] Int. Cl. .... D6-04

[52] U.S. Cl. .... D6/167; D6/157; D6/188

[58] Field of Search ..... D6/20, 23, 24, 25, 85, D6/127, 130, 145, 146, 148, 154, 157, 158, 164, 167, 168, 169

[56] References Cited

U.S. PATENT DOCUMENTS

D. 185,600	6/1959	Gaither .....	D6/188
D. 229,141	11/1973	Peckenpaugh .....	D6/167
D. 234,658	4/1975	Tillinger .....	D6/157
D. 240,986	8/1976	Young .....	D6/28 X
3,479,990	11/1969	Crow .....	D6/24 X
3,748,009	7/1973	Stone .....	D6/167 X

OTHER PUBLICATIONS

Lyon Kitchen Cabinets Catalog, p. 21, Cabinet No. 8110.

Sears Catalog, F & W 1975, p. 1185, Gun Cabinet at center.

Primary Examiner—Bruce W. Dunkins

Attorney, Agent, or Firm—Donald M. Seltzer

[57] CLAIM

The ornamental design for a combined gun and acces-

sory cabinet or similar article, substantially as shown and described.

DESCRIPTION

FIG. 1 is a perspective view of our combined gun and accessory cabinet or similar article in a closed condition showing our new design;

FIG. 2 is another perspective view of our combined gun and accessory cabinet or similar article in an opened condition;

FIG. 3 is a front perspective view thereof but on a larger scale;

FIG. 4 is a front perspective view of a second embodiment of our combined gun and accessory cabinet or similar article, as shown in FIG. 1;

FIG. 5 is a sectional view taken along line 5—5 of FIG. 4, but on a reduced scale;

FIG. 6 is another sectional view taken along line 6—6 of FIG. 4, but also on a reduced scale;

FIG. 7 is a perspective view of a third embodiment of our combined gun and accessory cabinet or similar article as shown in FIG. 1;

FIG. 8 is a front perspective view of the third embodiment shown in FIG. 7 but on a larger scale;

FIG. 9 is another front perspective view of the third embodiment shown in FIG. 7, but in a different rotative position;

FIG. 10 is a sectional view taken along the line 10—10 of FIG. 9, but on a reduced scale;

FIG. 11 is another sectional view taken along line 11—11 of FIG. 9 but also on a reduced scale;

FIG. 12 is a fifth embodiment of our combined gun and accessory cabinet or similar article, as shown in FIG. 1;

FIG. 13 is a front perspective view of the fourth embodiment of our design shown in FIG. 12 but on a larger scale; and

FIG. 14 is a front perspective view of a sixth embodiment of our combined gun and accessory cabinet or similar article shown in FIG. 1.

The rear and the one side of a combined gun and accessory cabinet or similar article not shown in the drawings are substantially plain and unornamented.

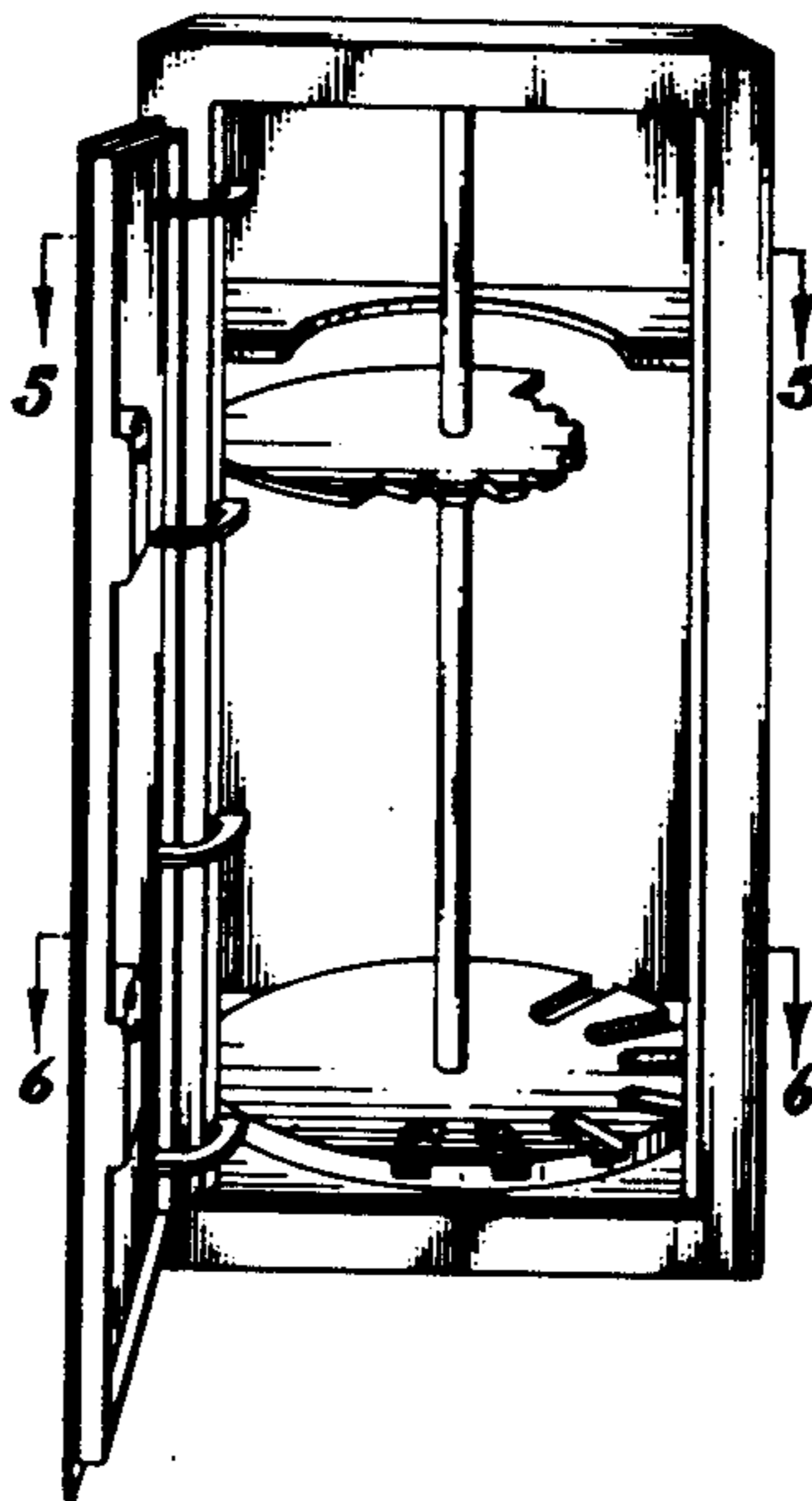

Fig-1

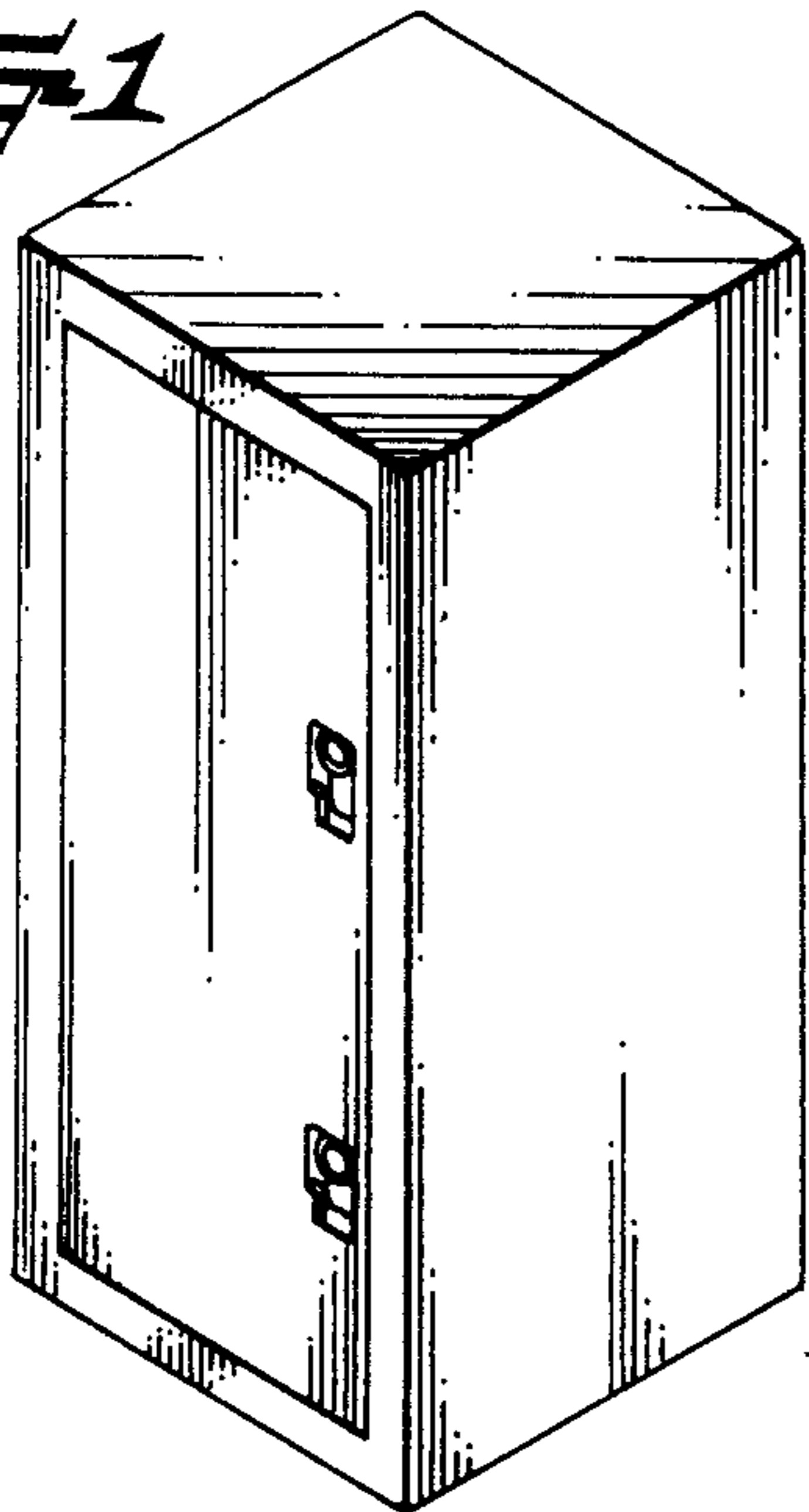

Fig-2

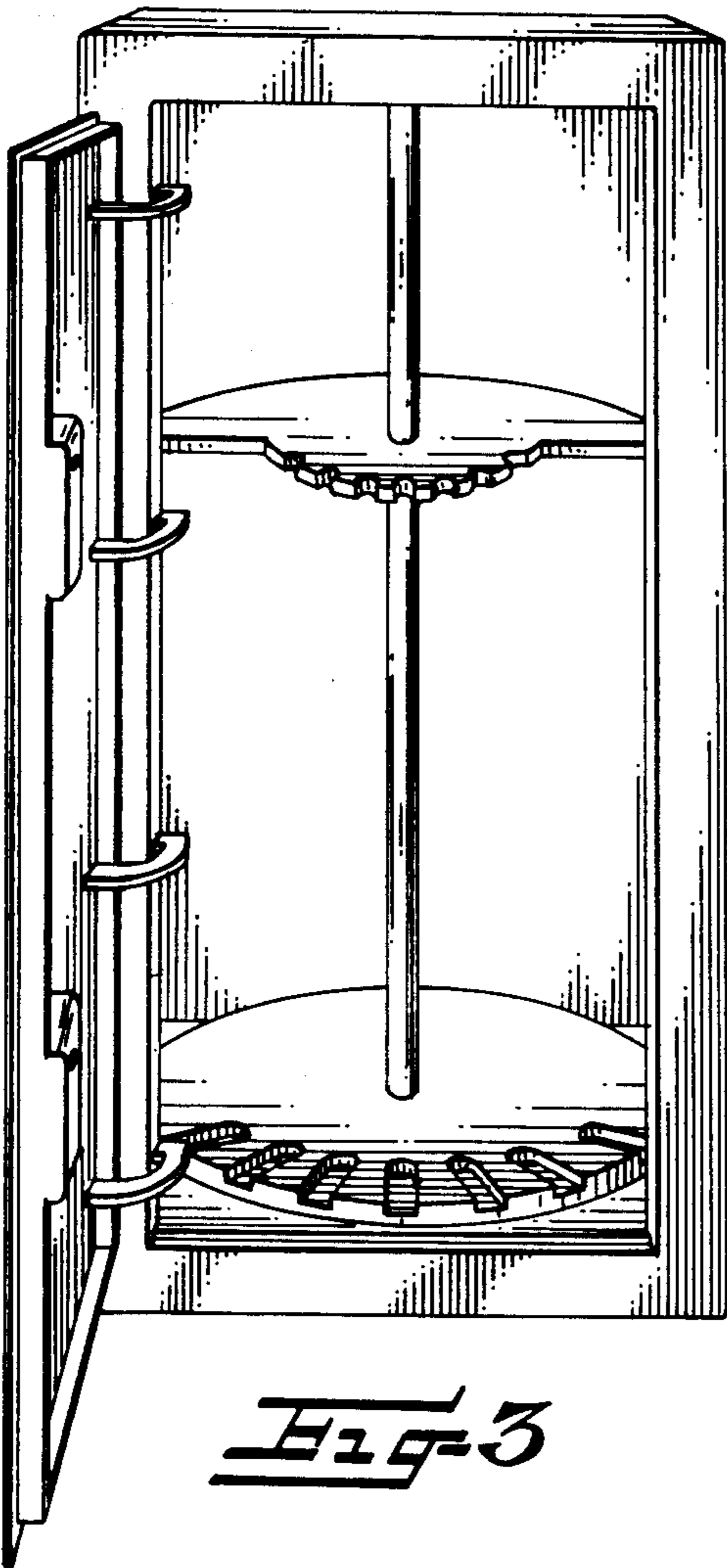
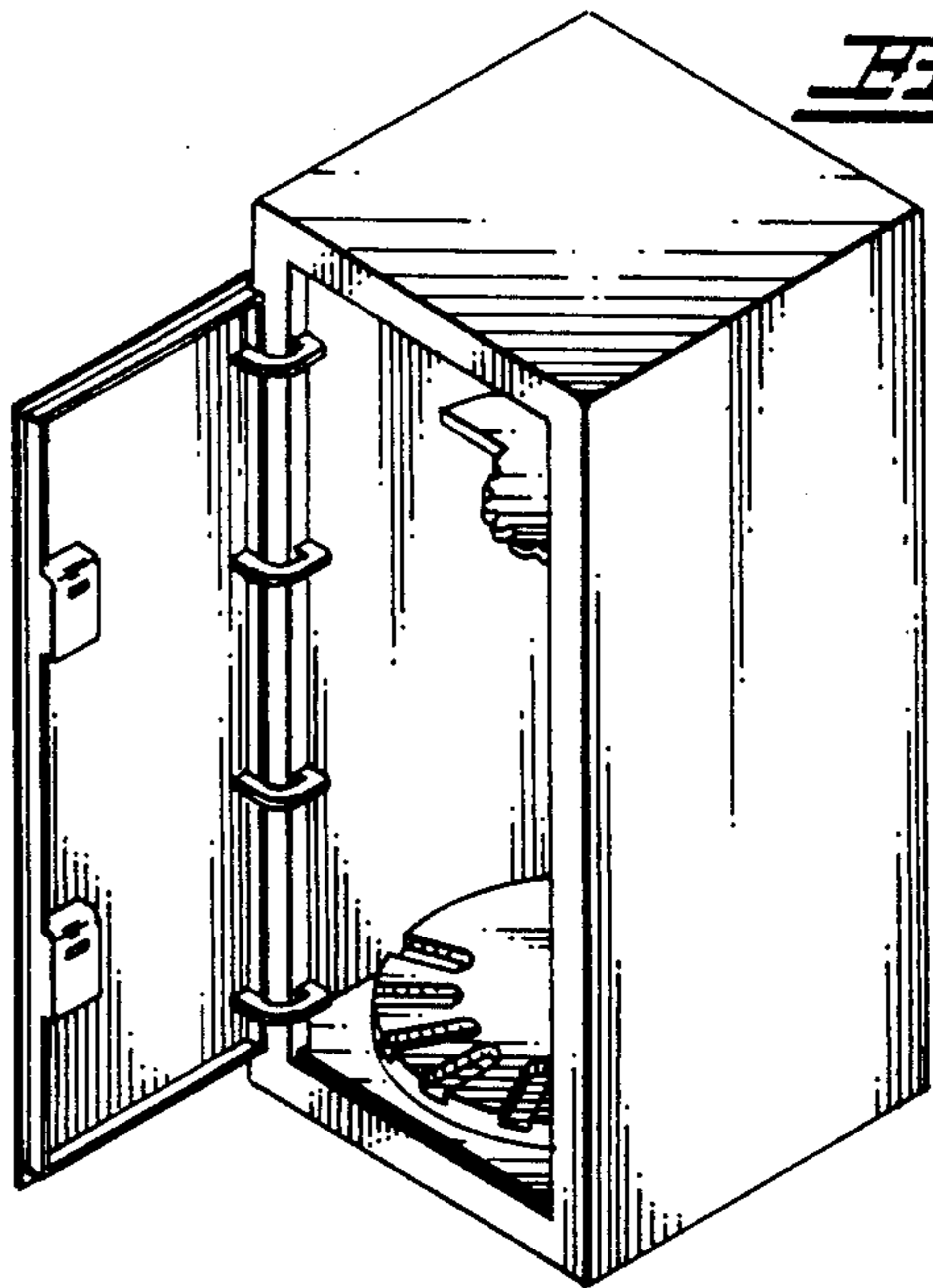

Fig-3

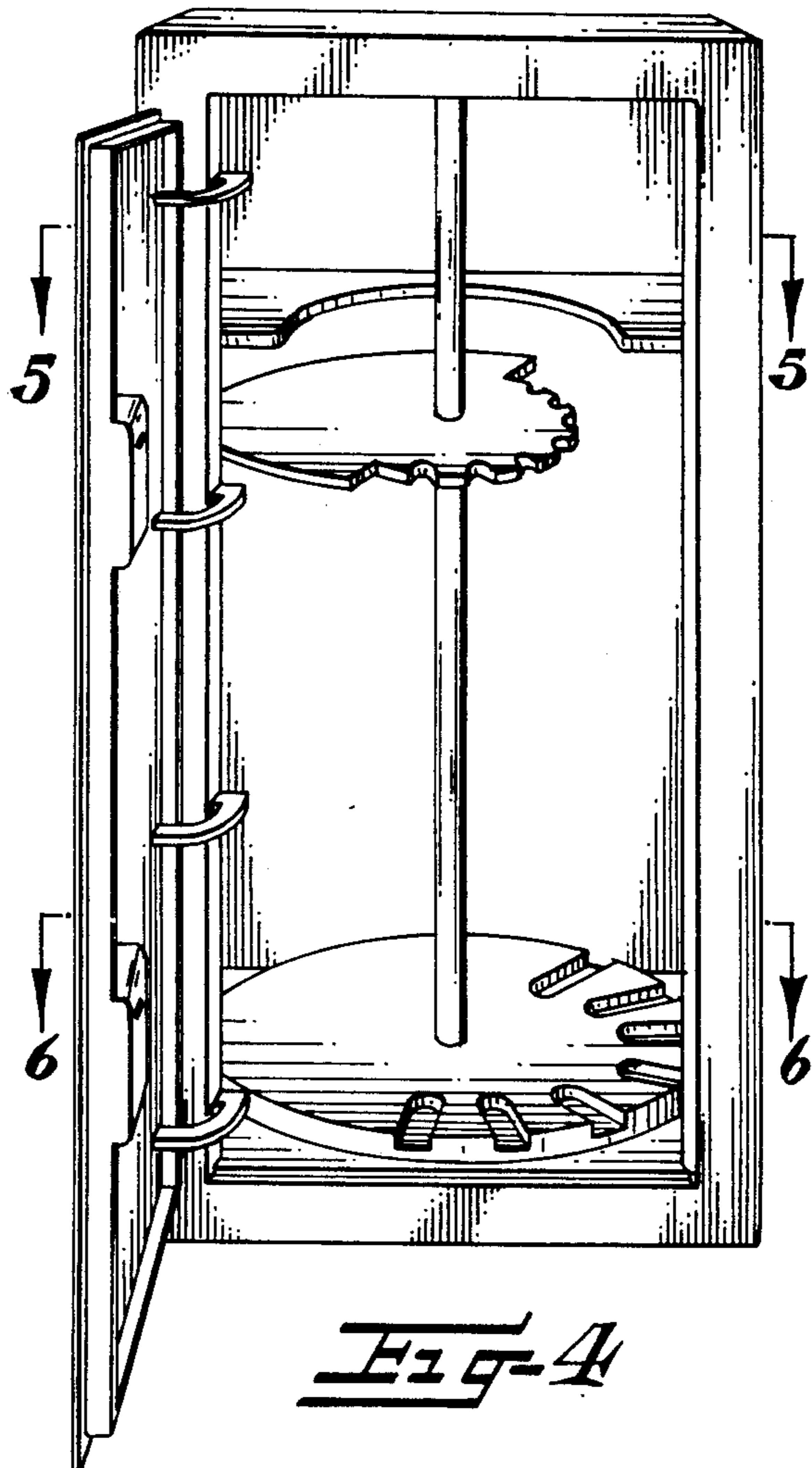

Fig-4

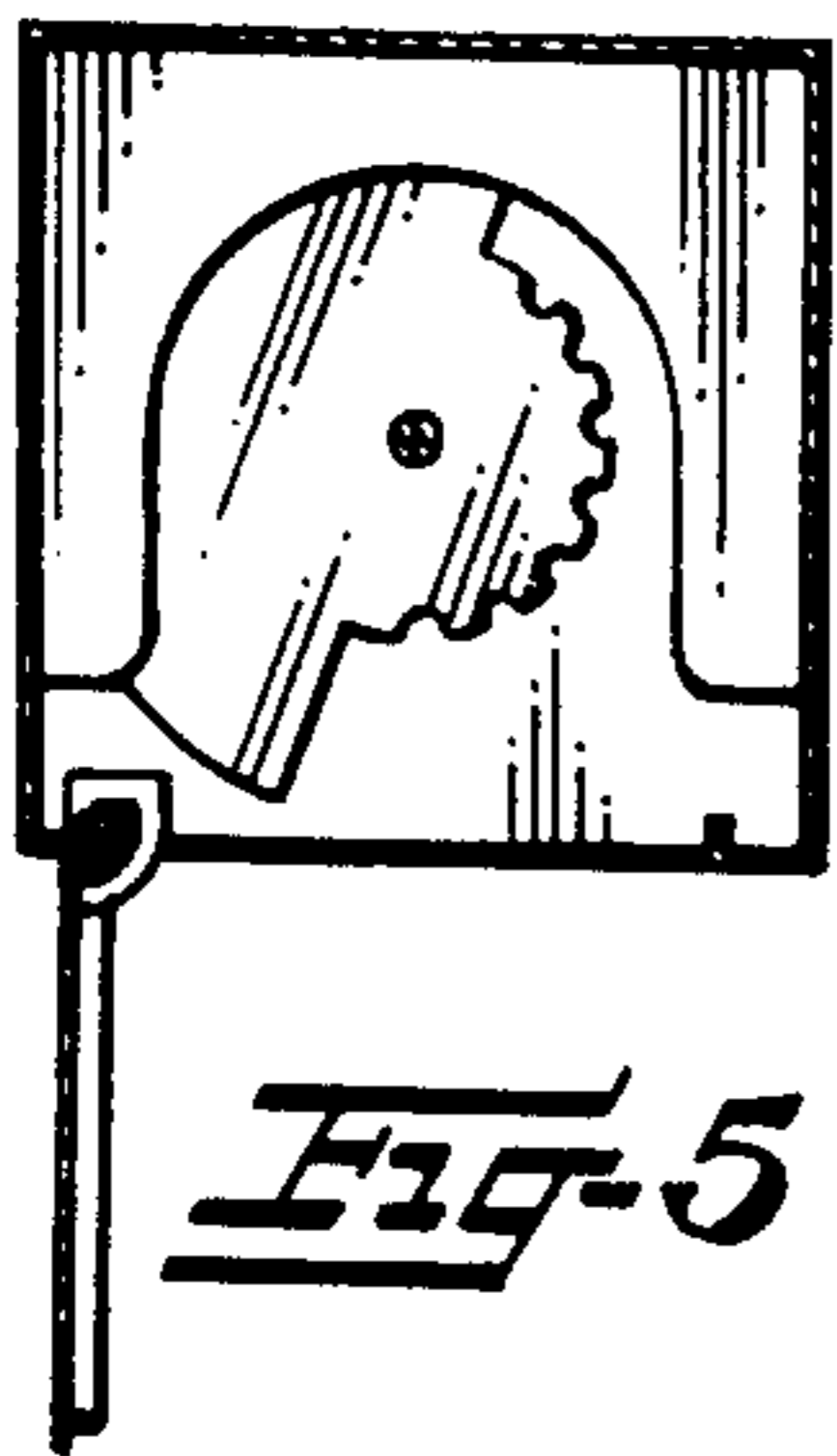

FIG-5

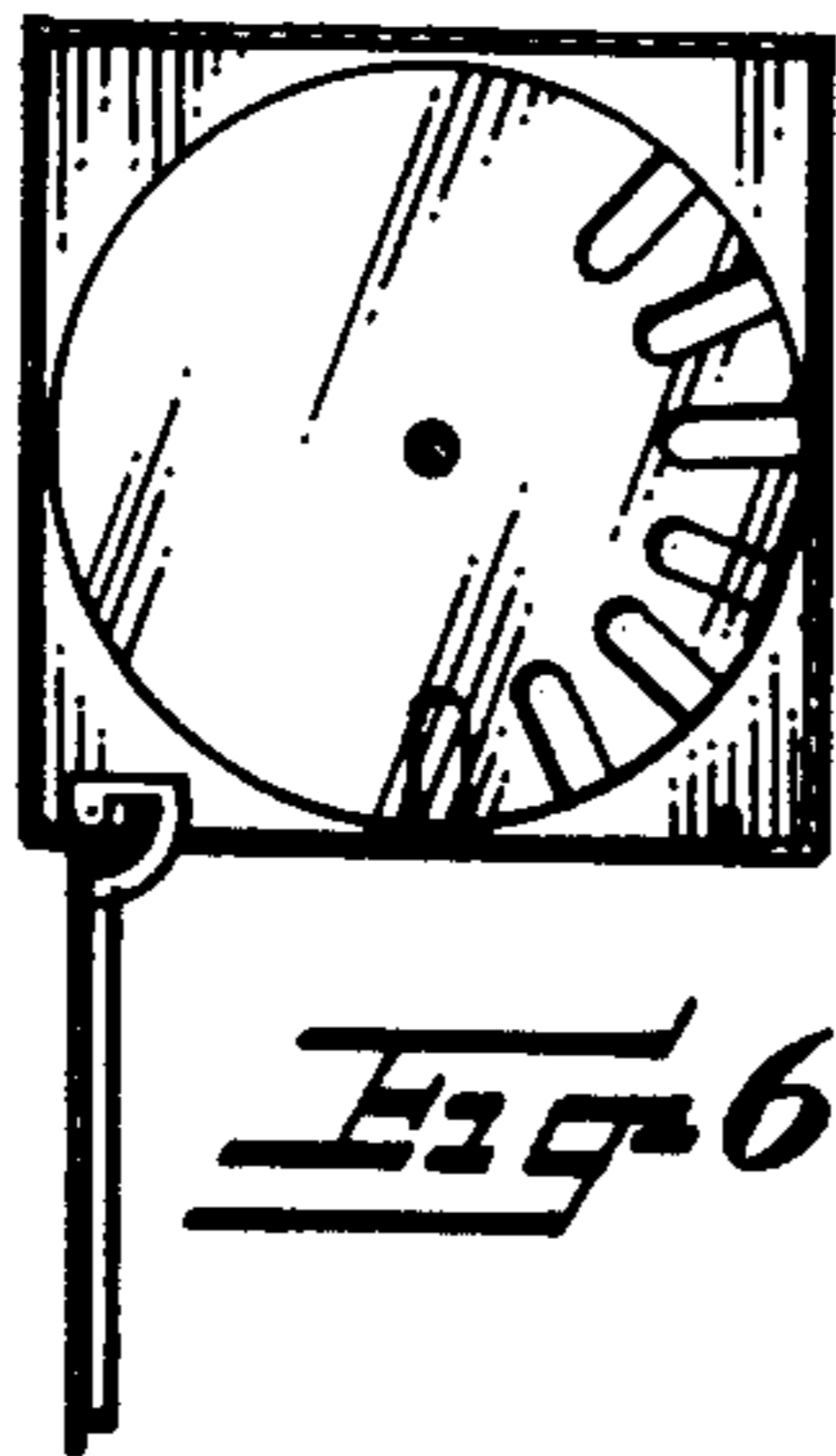

FIG-6

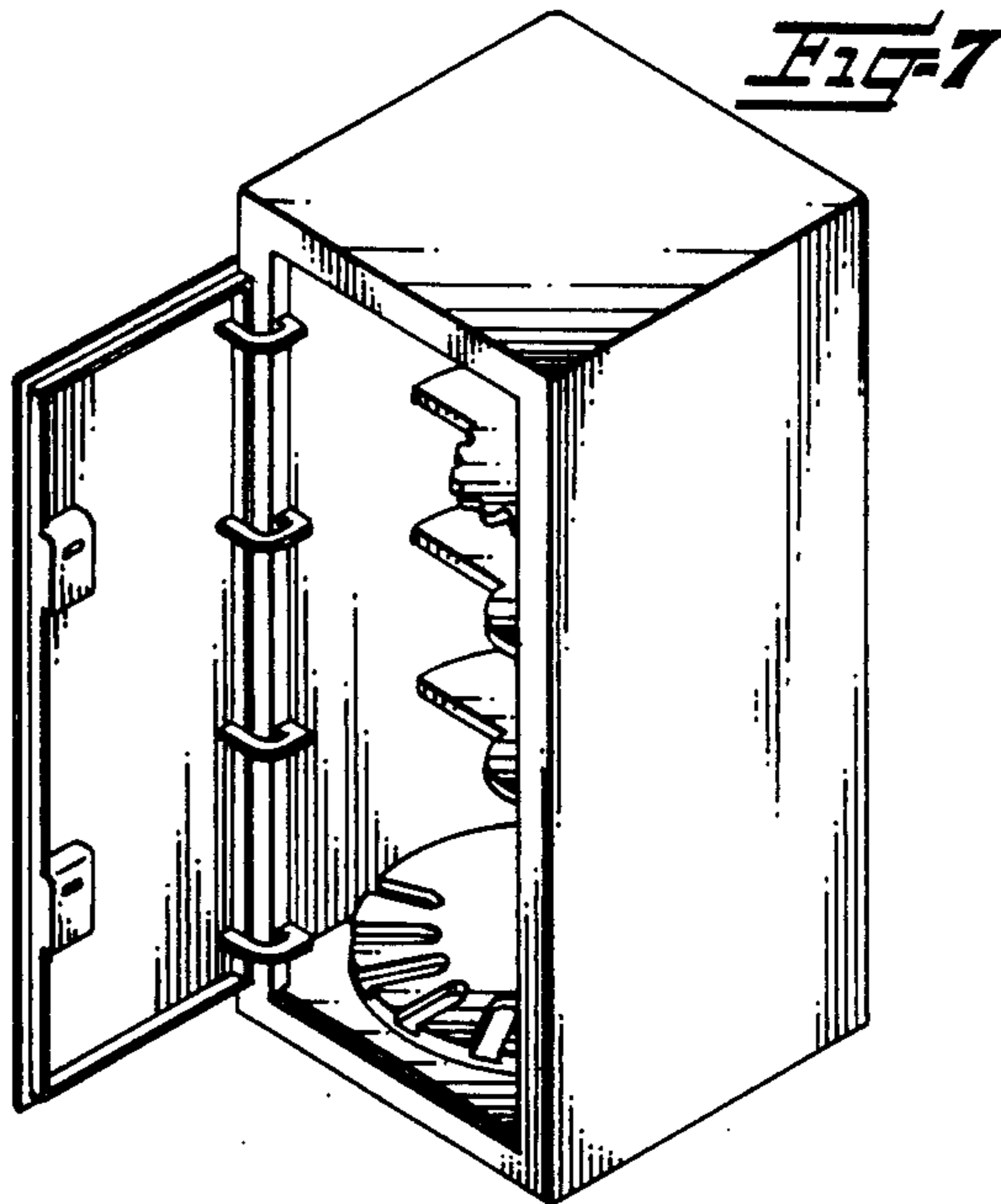

FIG-7

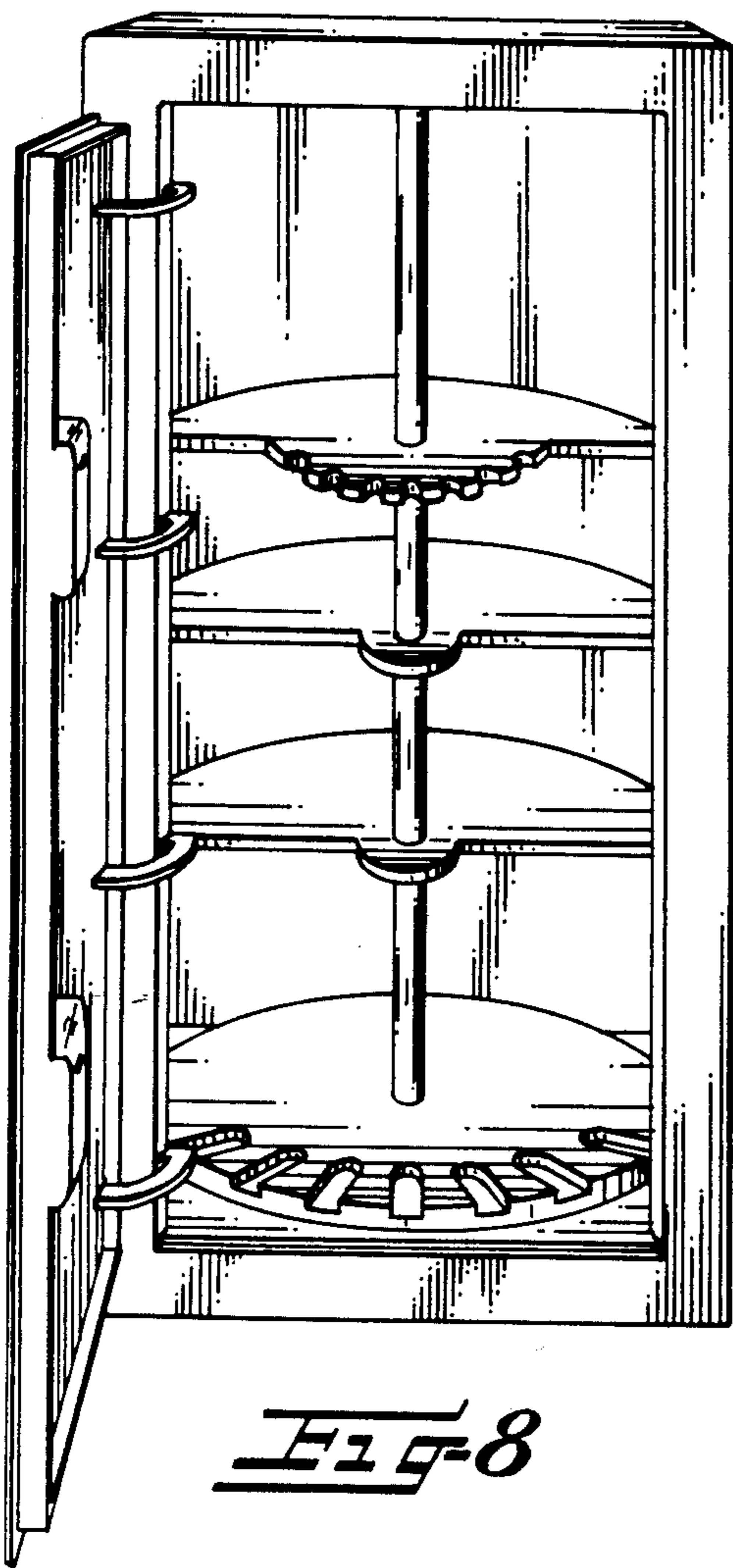

FIG-8

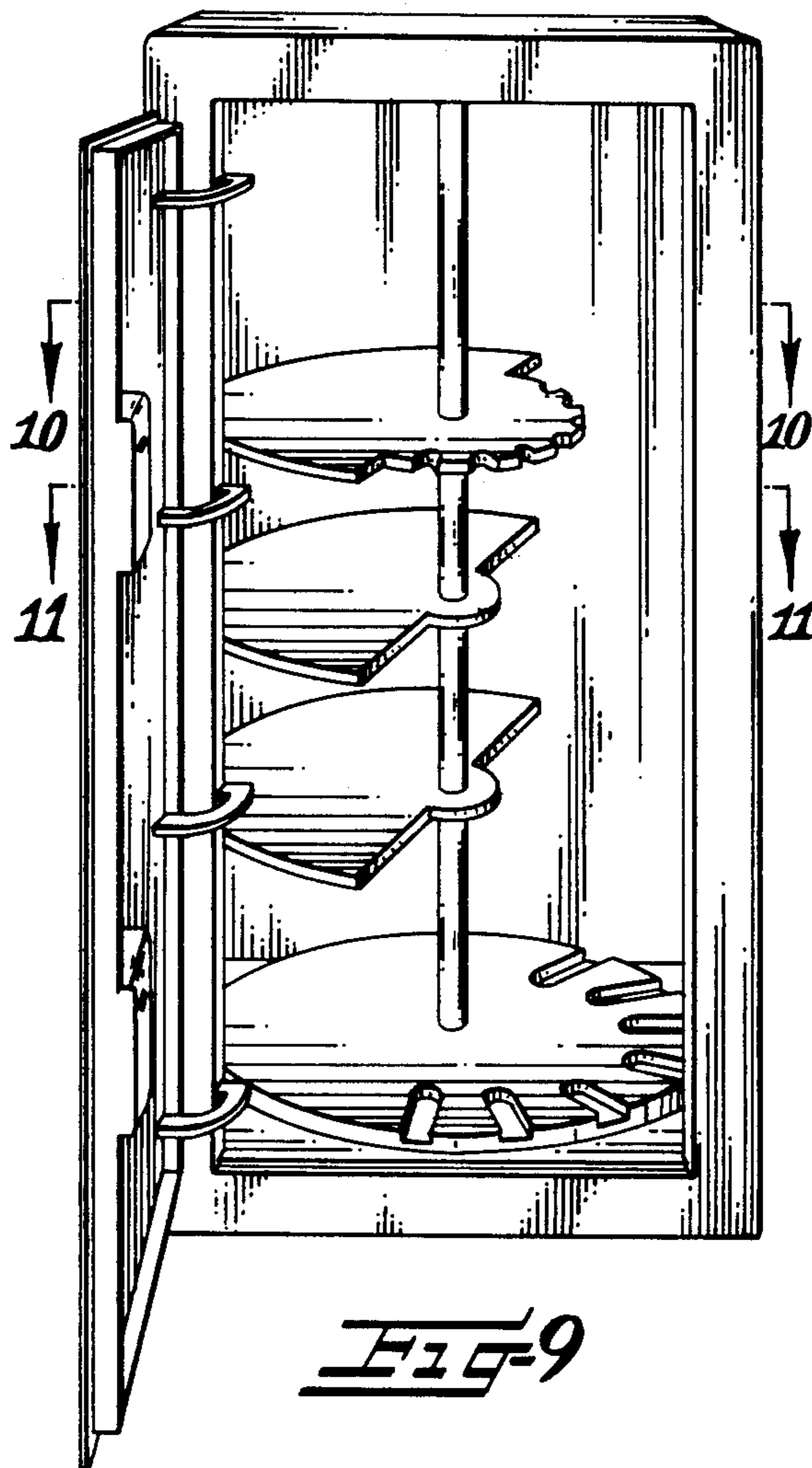
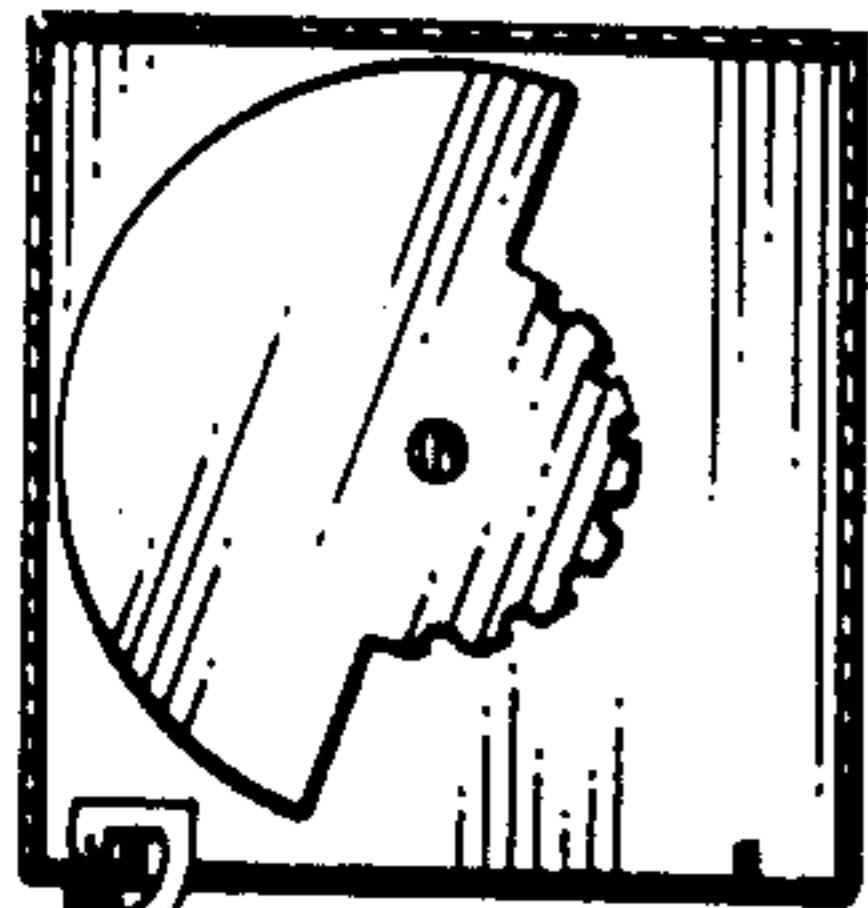
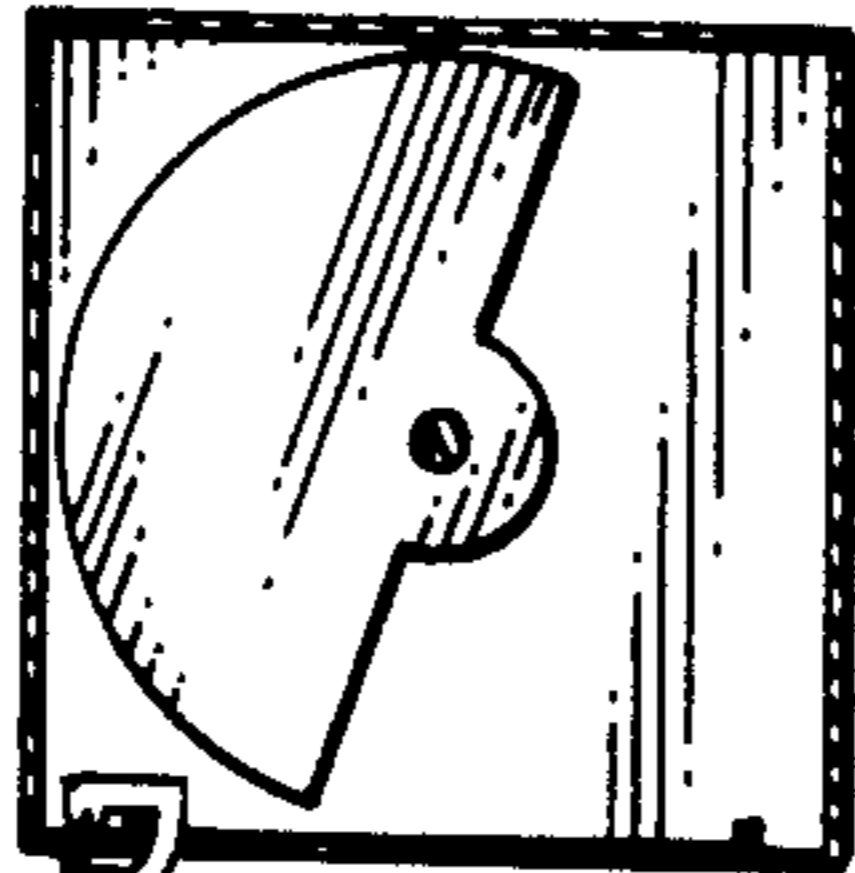

FIG-9



**FIG-10**



**FIG-11**

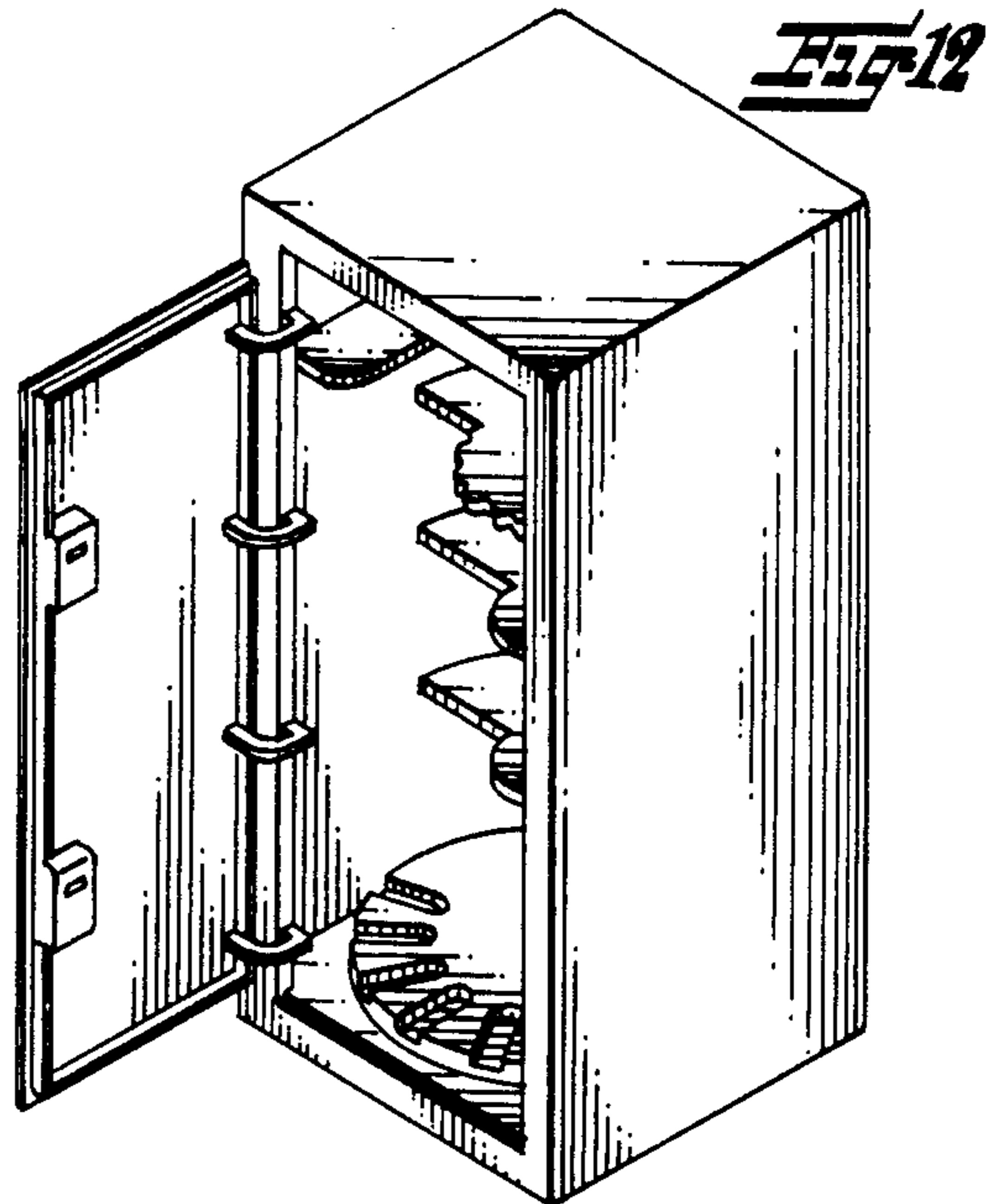

**FIG-12**

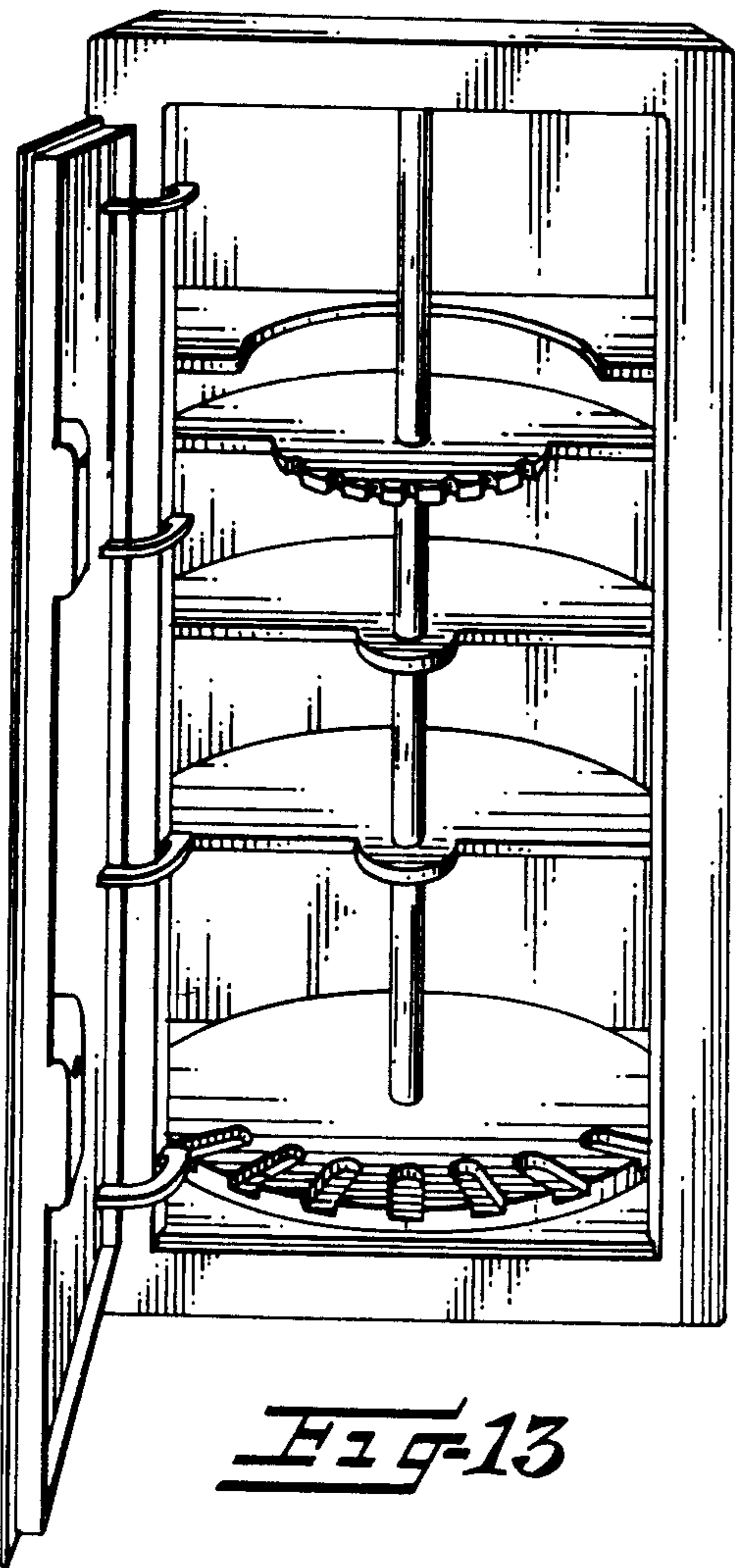

**FIG-13**

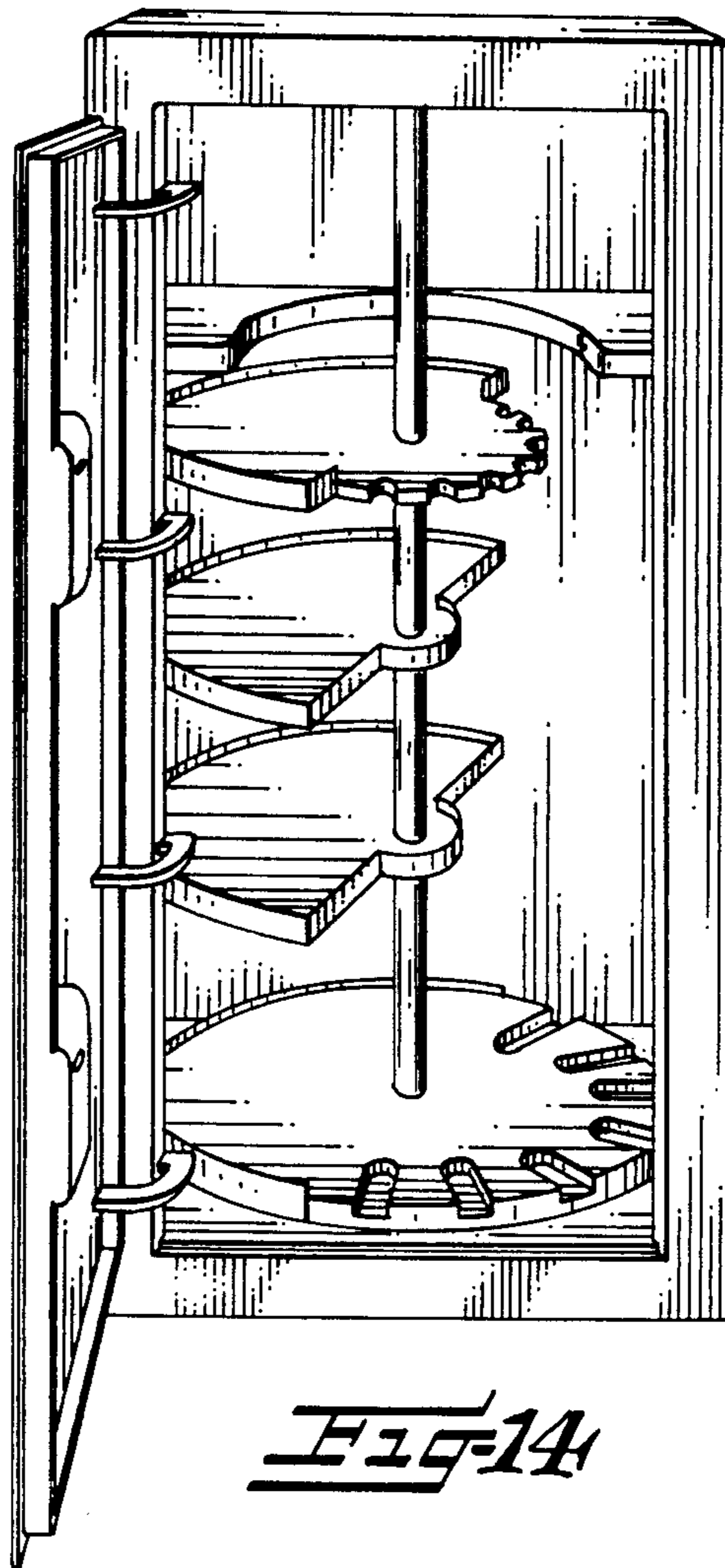

**FIG-14**

UNITED STATES PATENT AND TRADEMARK OFFICE  
**CERTIFICATE OF CORRECTION**

PATENT NO. : Des. 252,125  
DATED : June 19, 1979  
INVENTOR(S) : Ervin C. Oakley; George R. Bell; William E. Poole

It is certified that error appears in the above-identified patent and that said Letters Patent are hereby corrected as shown below:

In the Fig. 12 description, change "fifth embodiment" to --fourth embodiment--. In the Fig. 14 description, change "sixth embodiment" to --fifth embodiment--

**Signed and Sealed this**

*Second Day of October 1979*

[SEAL]

*Attest:*

**RUTH C. MASON**  
*Attesting Officer*

**LUTRELLE F. PARKER**  
*Acting Commissioner of Patents and Trademarks*