

[54] **COMBINED MODULAR DESK AND
MULTIPLE SEAT UNIT**

[76] Inventor: **Jimmy R. Patterson**, 5337 Reef Way,
Oxnard, Calif. 93030

[**] Term: **14 Years**

[21] Appl. No.: **804,183**

[22] Filed: **Jun. 6, 1977**

[51] Int. Cl. **D6-05**

[52] U.S. Cl. **D6/45; D6/157**

[58] Field of Search **D6/1, 4, 42, 43, 44,
D6/45, 47, 65, 66, 26, 157, 156, 158, 161, 162;
108/50; 297/135, 136, 137, 144, 156, 174**

[56] **References Cited**

U.S. PATENT DOCUMENTS

- D. 206,840 1/1967 Ziegelman et al. D6/157
- D. 210,133 2/1968 Miller et al. D6/162

- D. 211,886 8/1968 Benjamin D6/45
- D. 216,714 3/1970 Cooper D6/45
- D. 225,942 1/1973 Anderson D6/157
- D. 234,238 2/1975 Miller D6/45

Primary Examiner—Bruce W. Dunkins
Attorney, Agent, or Firm—Ralph B. Pastoriza

[57] **CLAIM**

The ornamental design for a combined modular desk and multiple seat unit, substantially as shown.

DESCRIPTION

FIG. 1 is a perspective view of a combined modular desk and multiple seat unit showing my new design; FIG. 2 is a side elevational view thereof; FIG. 3 is a rear elevational view thereof; FIG. 4 is a front elevational view thereof; FIG. 5 is a top plan view thereof; FIG. 6 is a bottom plan view thereof; and FIG. 7 is a greatly enlarged fragmentary perspective of one of the pedestals of the modular desk.

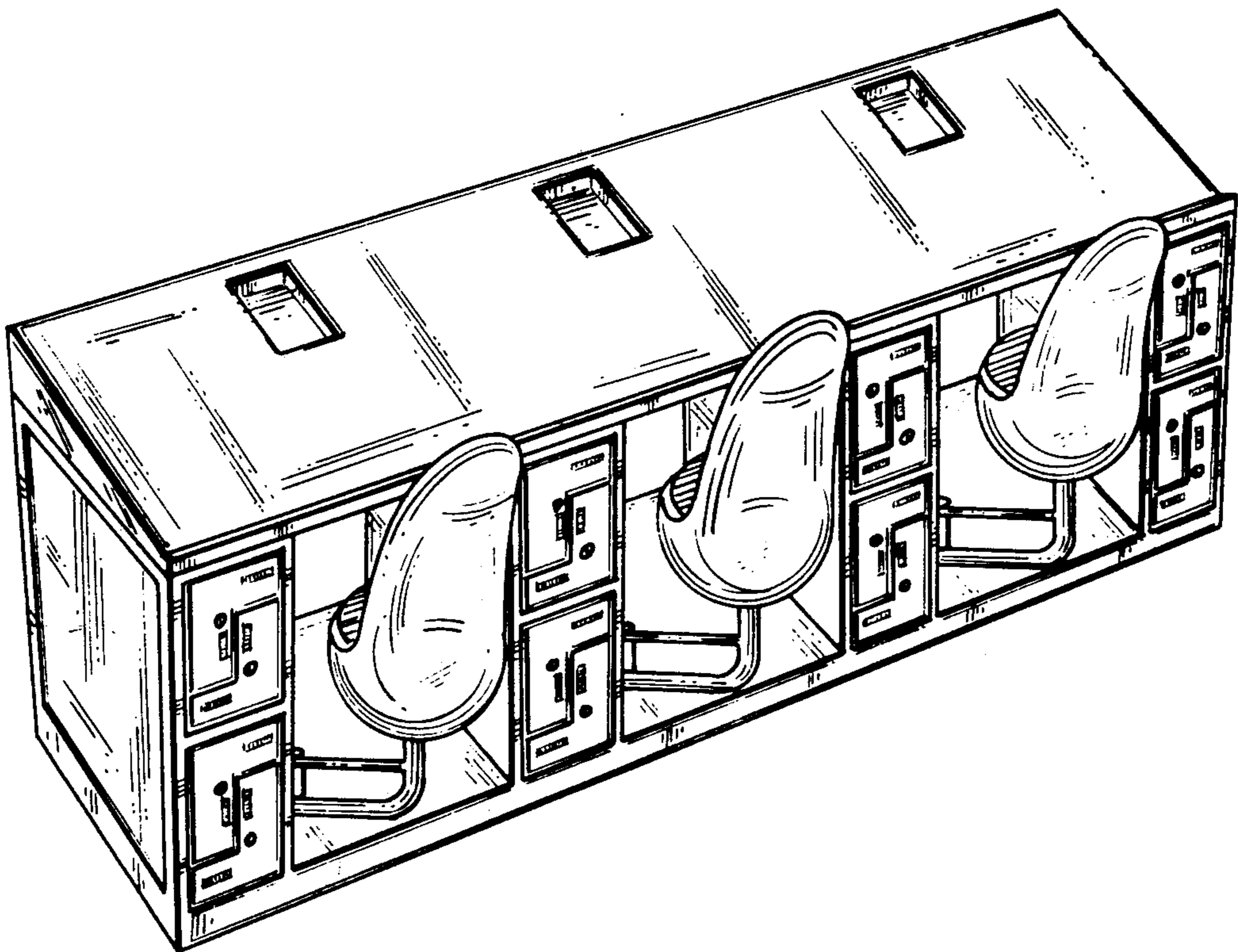

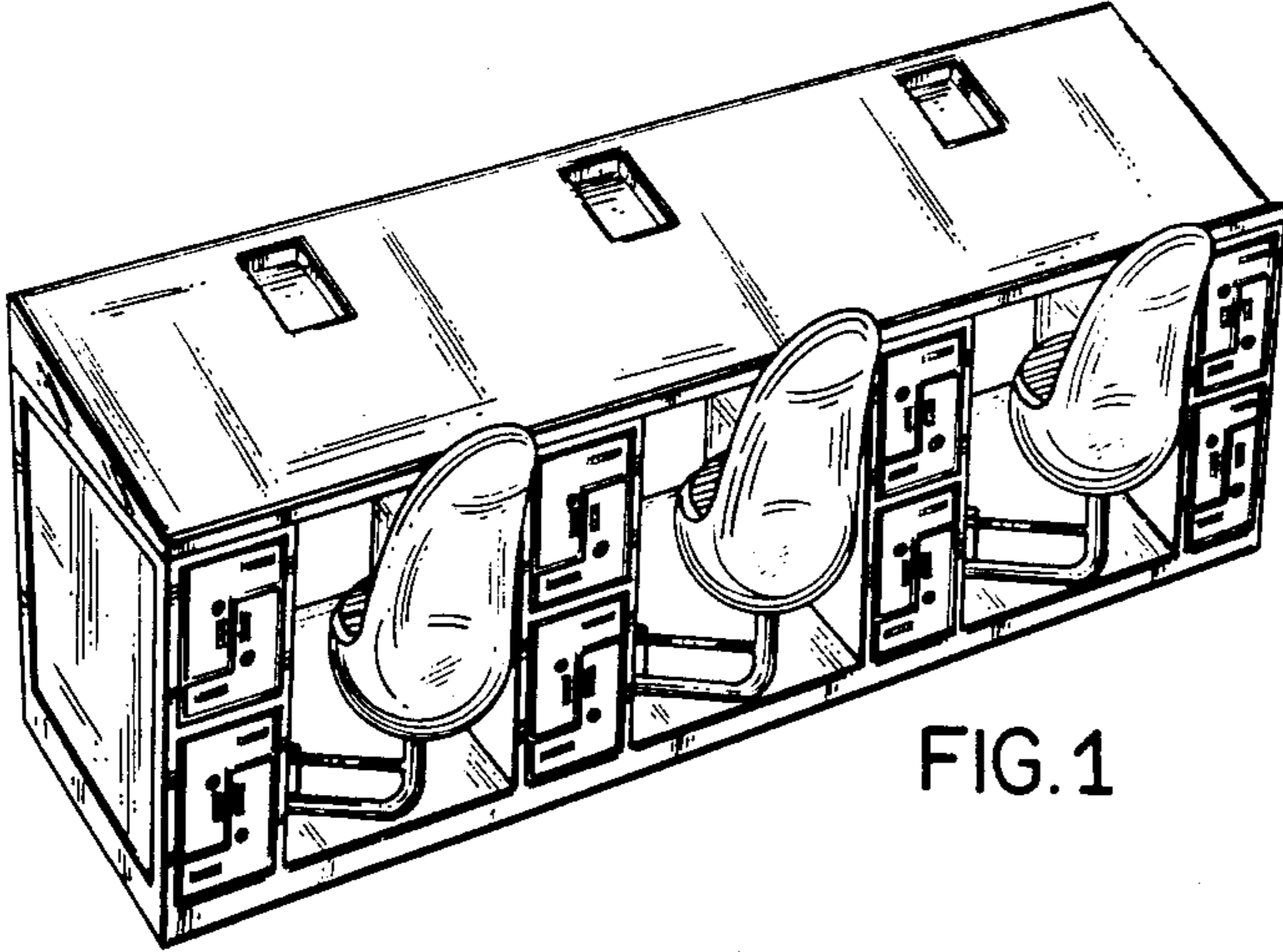

FIG. 1

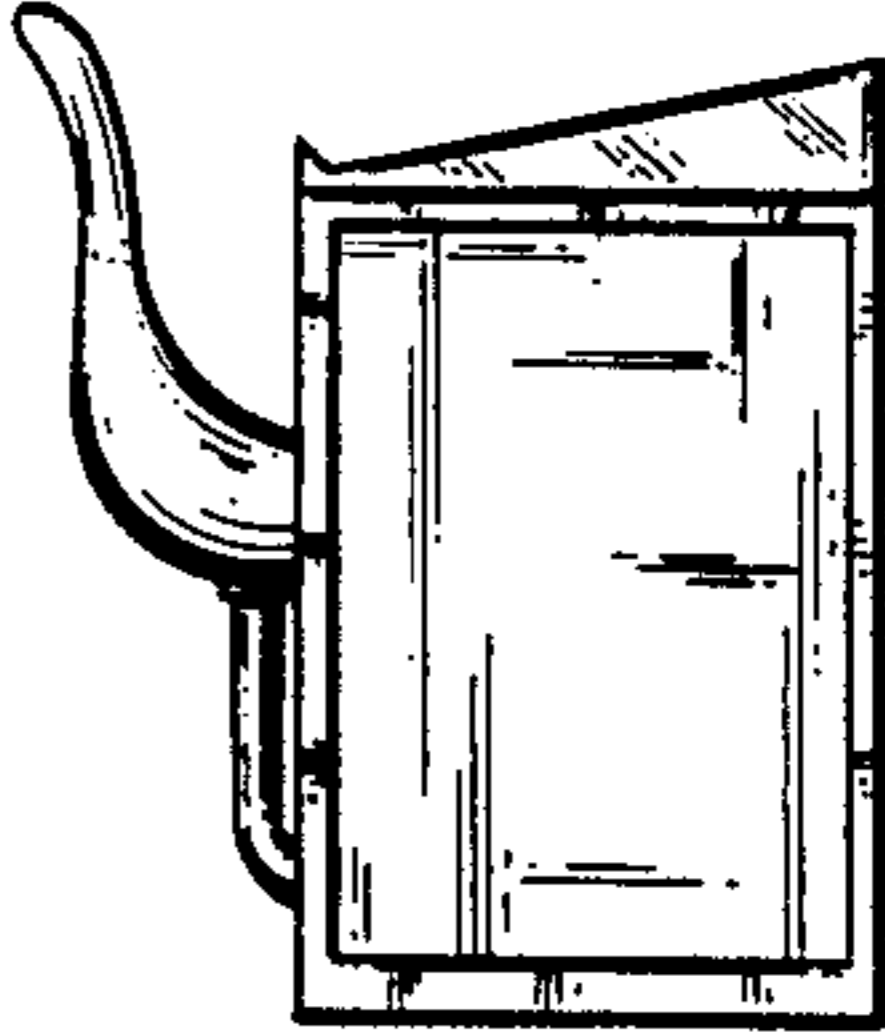

FIG. 2

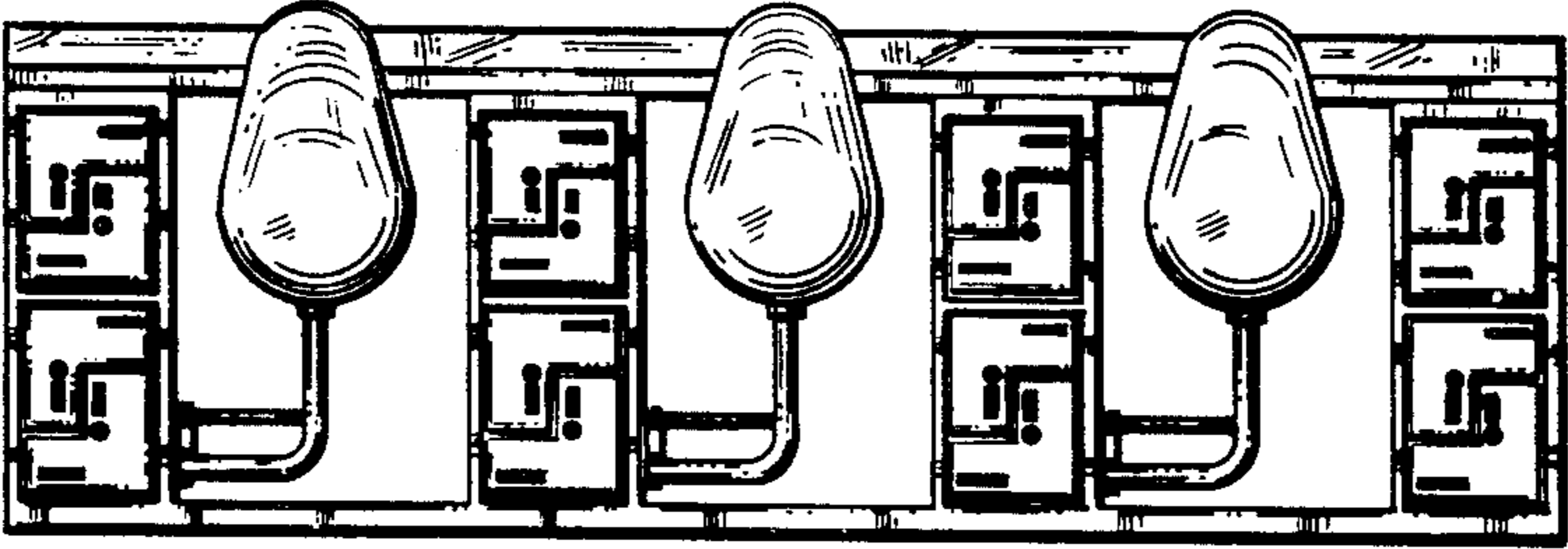

FIG. 3

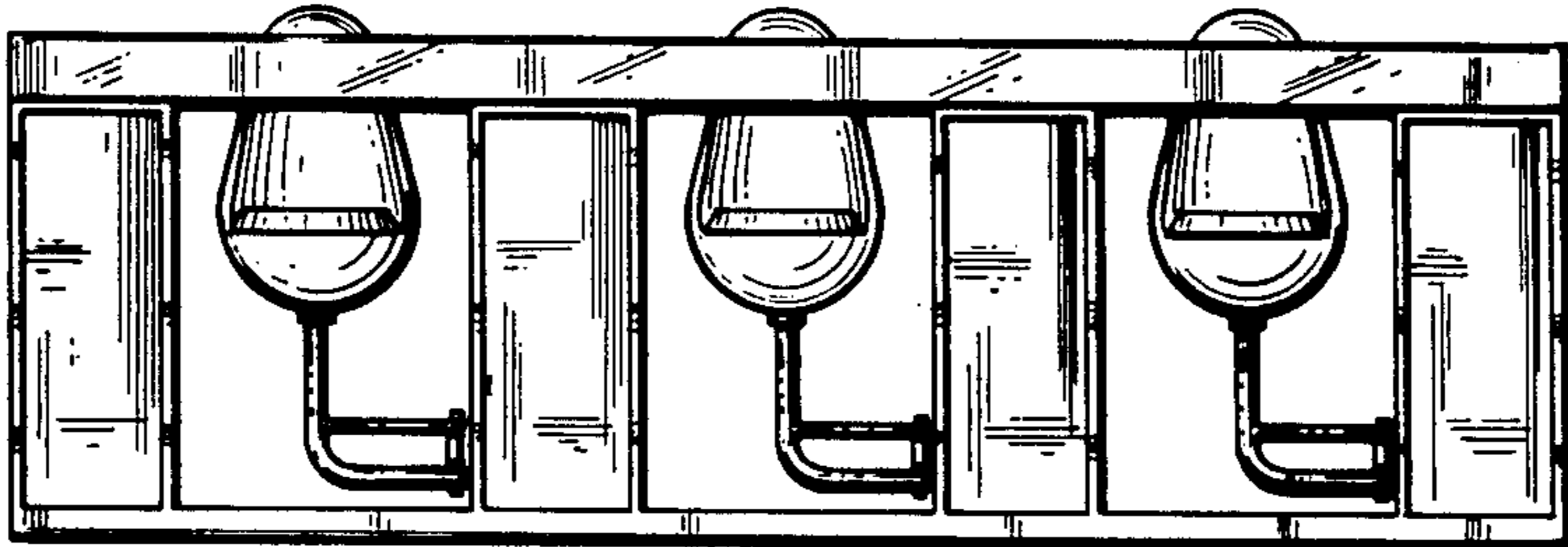

FIG. 4

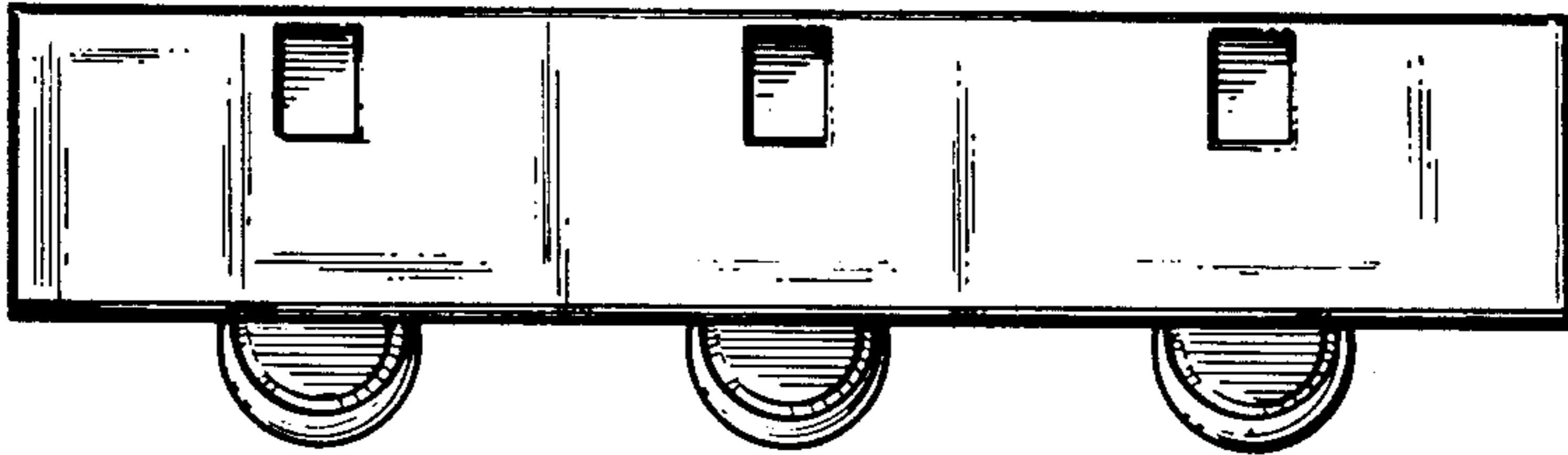

FIG. 5

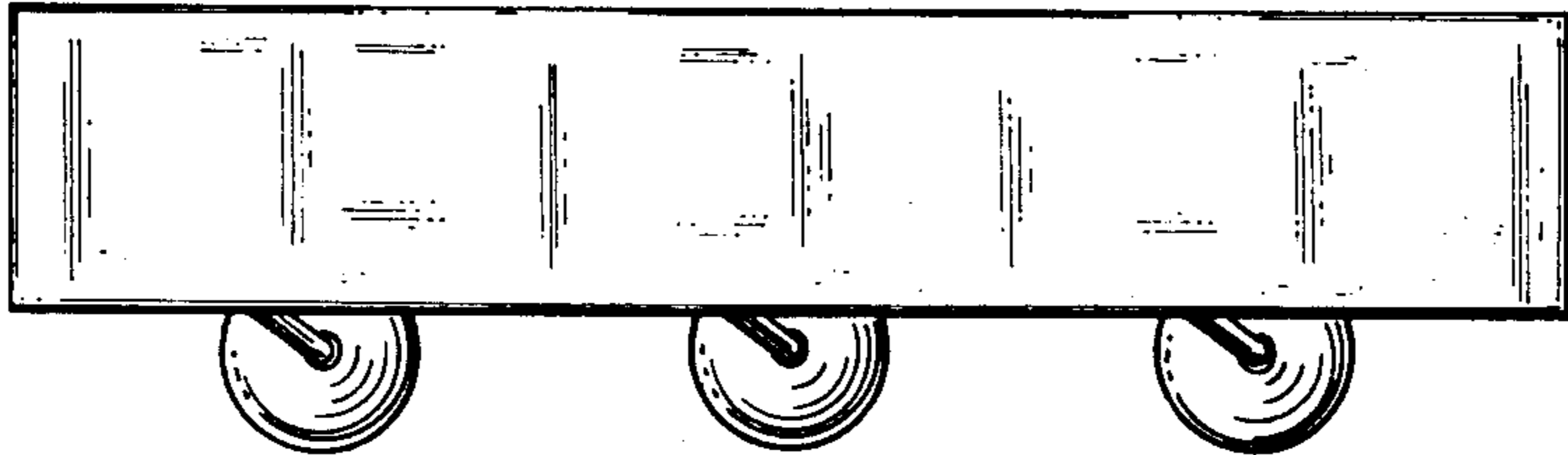

FIG. 6

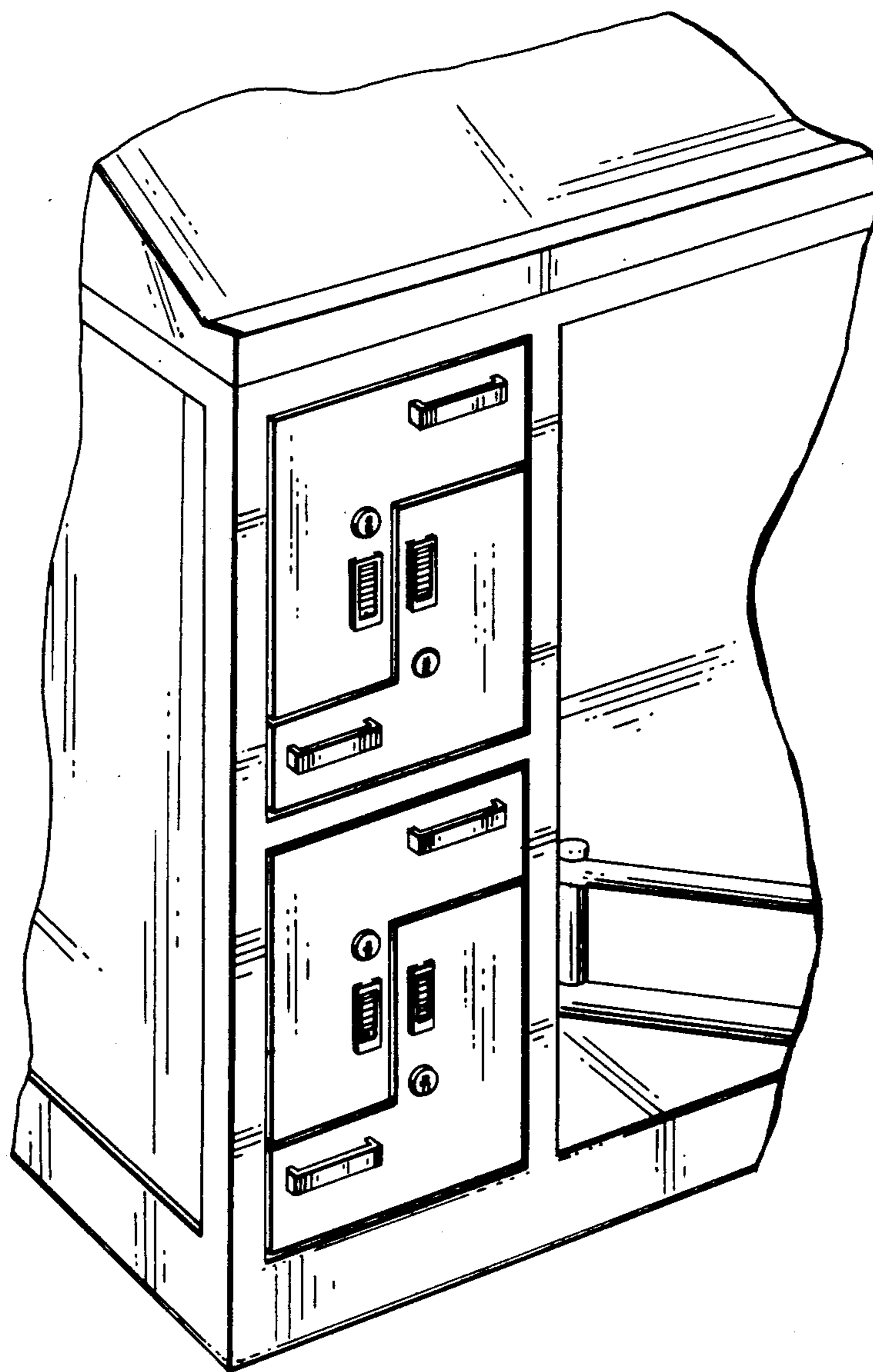

FIG. 7