

[54] FISHING ROD GRIP

[75] Inventor: Hideo Nakamura, Tokyo, Japan

[73] Assignee: Daiwa Selko, Inc., Higashikurume, Japan

[**] Term: 14 Years

[21] Appl. No.: 818,032

[22] Filed: Jul. 22, 1977

[30] Foreign Application Priority Data

Apr. 4, 1977 [JP] Japan 52/12332

[51] Int. Cl. D22-05

[52] U.S. Cl. D22/23

[58] Field of Search D22/23, 26; 43/23, 18 R, 43/21.2, 22, 25.2

[56] References Cited

U.S. PATENT DOCUMENTS

D. 223,826 6/1972 Harrell D22/23
D. 225,528 12/1972 Tate et al. D22/23

Primary Examiner—A Hugo Word
Attorney, Agent, or Firm—Richard C. Sughrue

[57] CLAIM

The ornamental design for a fishing rod grip, as shown and described.

DESCRIPTION

FIG. 1 is a top plan view of a fishing rod grip showing my new design;
FIG. 2 is a right side view;
FIG. 3 is a bottom plan view;
FIG. 4 is a left side view;
FIG. 5 is a front view;
FIG. 6 is a rear view; and
FIG. 7 is a right side view as positioned to receive a fishing reel shown in phantom line.

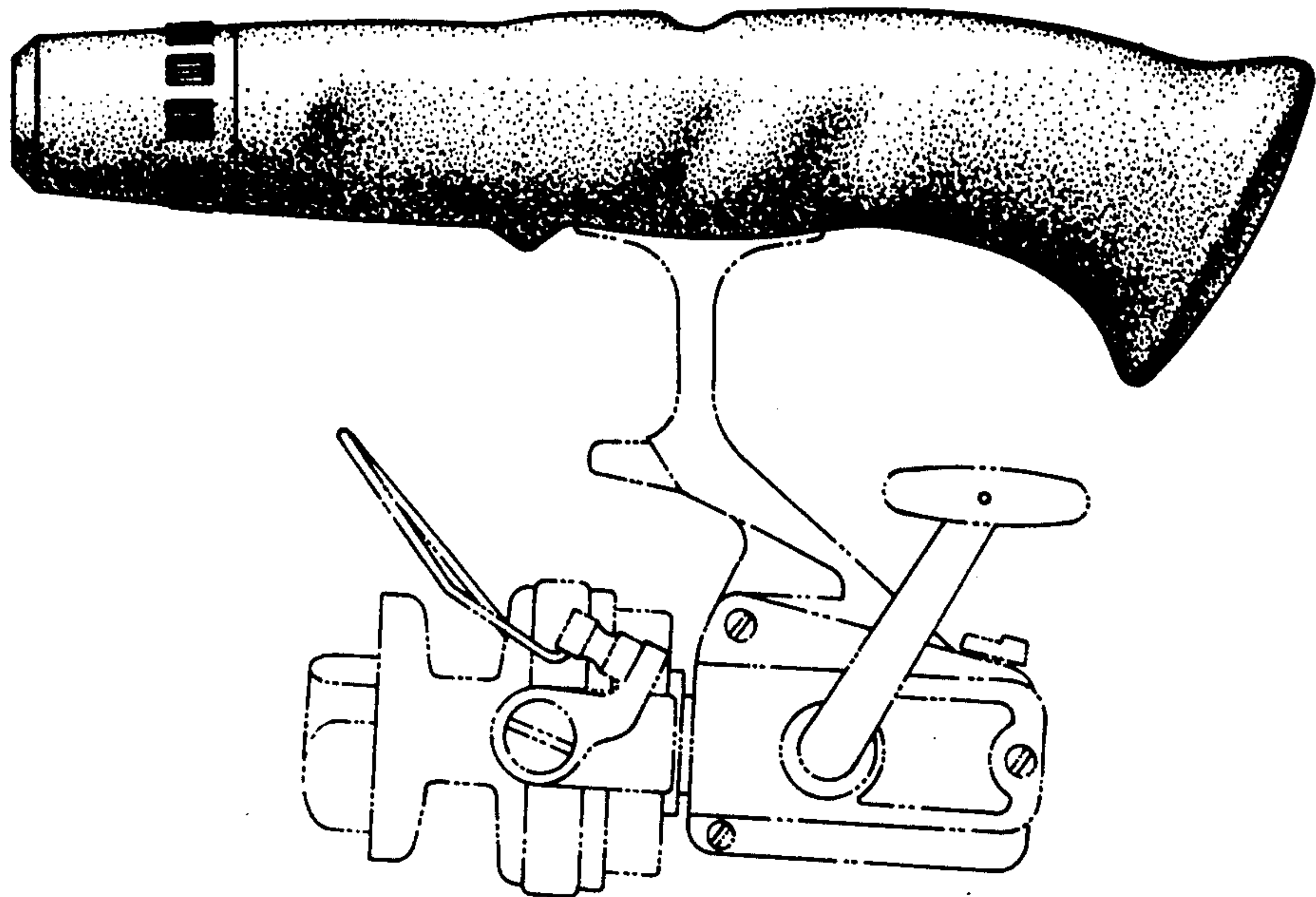

FIG. 1

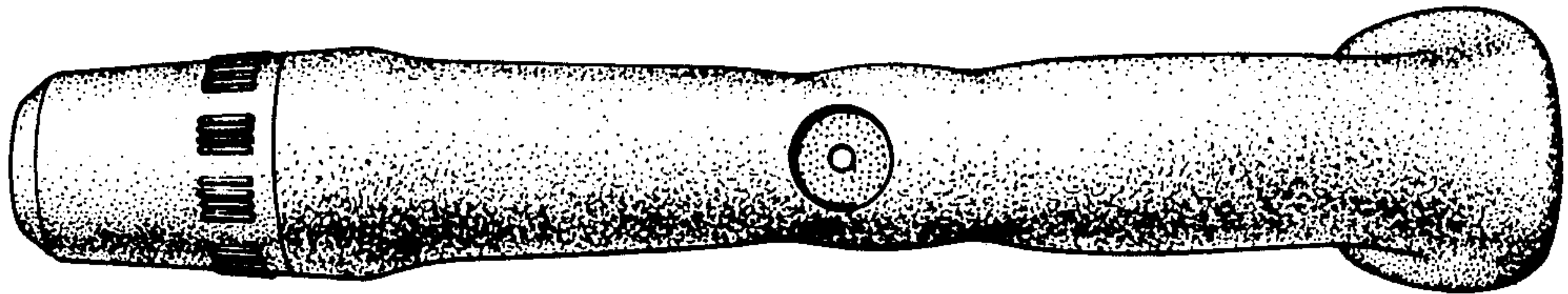

FIG. 2

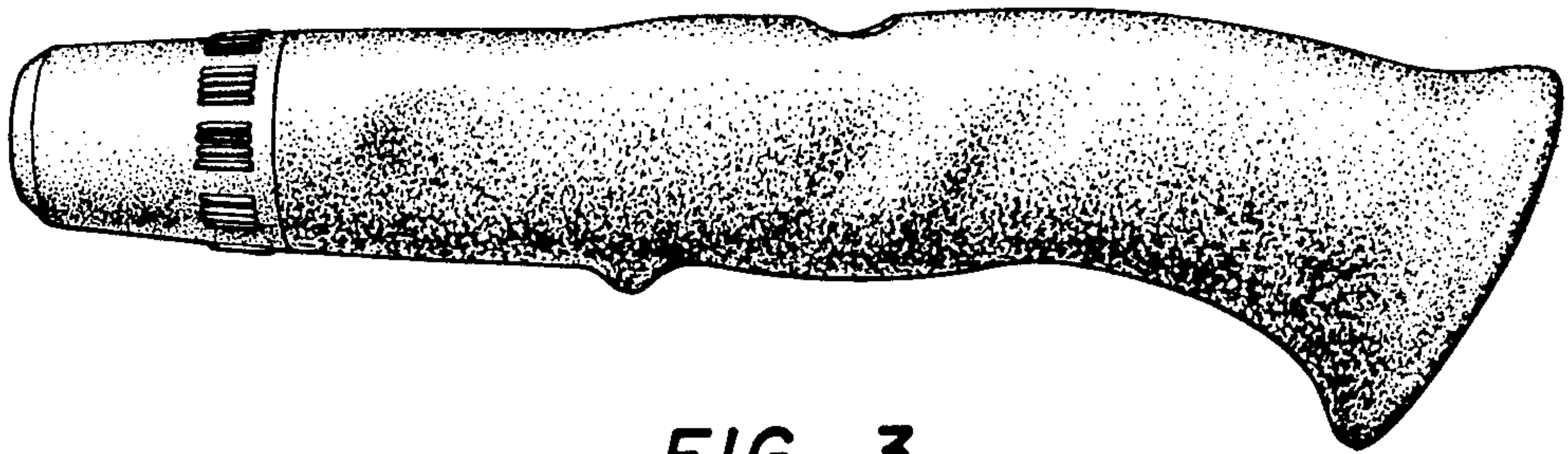

FIG. 3

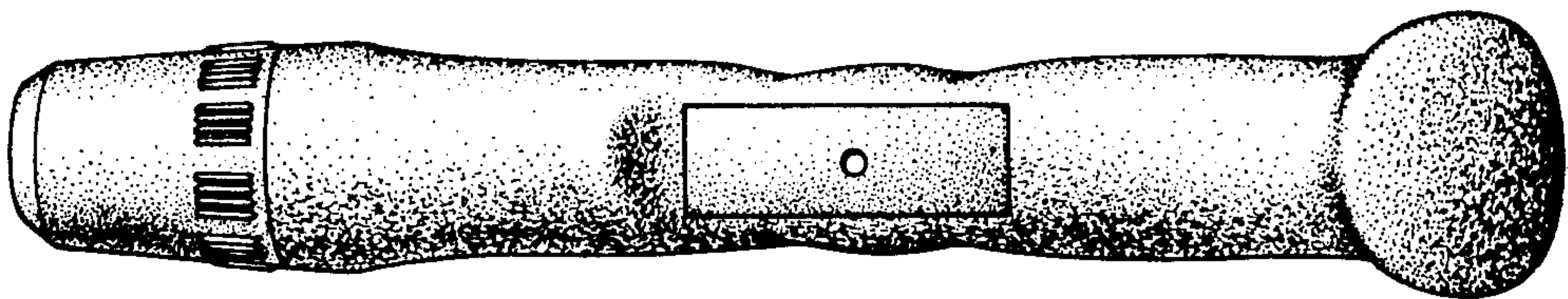

FIG. 4

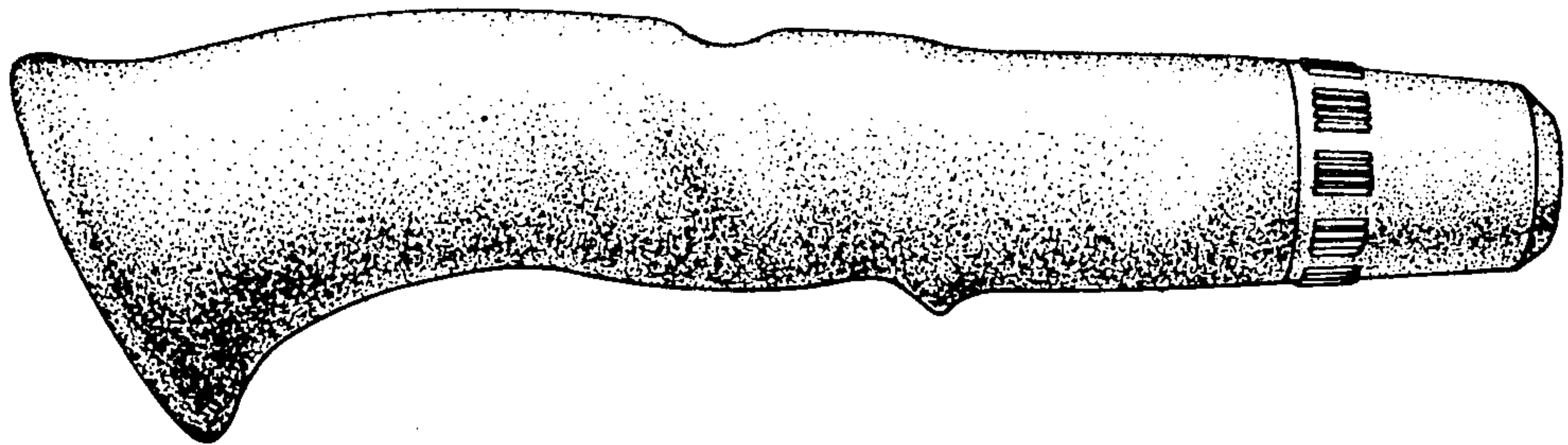

FIG. 5

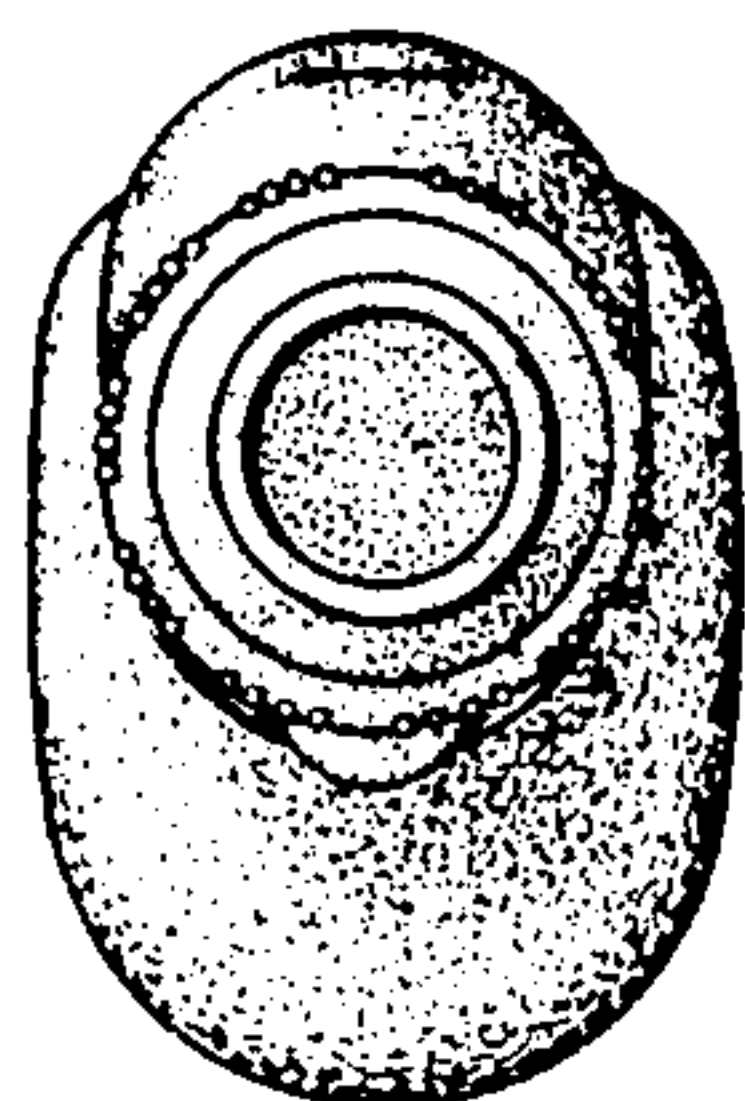

FIG. 6

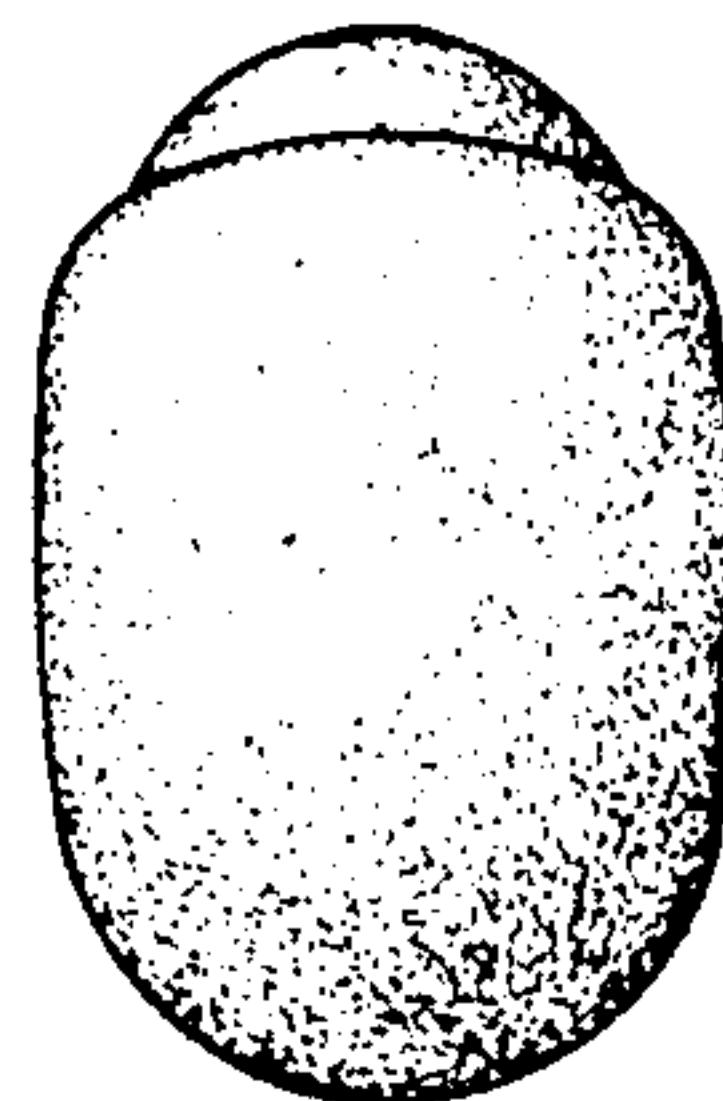

FIG. 7

