

[54] STAPLER

[75] Inventor: John J. Power, Westbury, N.Y.

[73] Assignee: Swingline, Inc., Long Island City, N.Y.

[**] Term: 14 Years

[21] Appl. No.: 753,523

[22] Filed: Dec. 22, 1976

[51] Int. Cl. D19-02

[52] U.S. Cl. D8/50

[58] Field of Search D8/49, 50; D19/72; 227/61

[56] References Cited

U.S. PATENT DOCUMENTS

D. 118,379 1/1940 Maynard D8/50
D. 241,502 9/1976 Goertz D8/50

D. 243,148 1/1977 Levin D8/50
D. 244,253 5/1977 Power D8/50

Primary Examiner—Joel Stearman
Assistant Examiner—George P. Word
Attorney, Agent, or Firm—Willis H. Taylor, Jr.

[57] CLAIM

The ornamental design for a stapler, substantially as shown and described.

DESCRIPTION

FIG. 1 is a perspective view of a stapler showing my new design;
FIG. 2 is a right side elevational view;
FIG. 3 is a left side elevational view;
FIG. 4 is a top plan view;
FIG. 5 is a front elevational view;
FIG. 6 is a rear elevational view; and
FIG. 7 is a perspective view of the stapler in a closed condition.

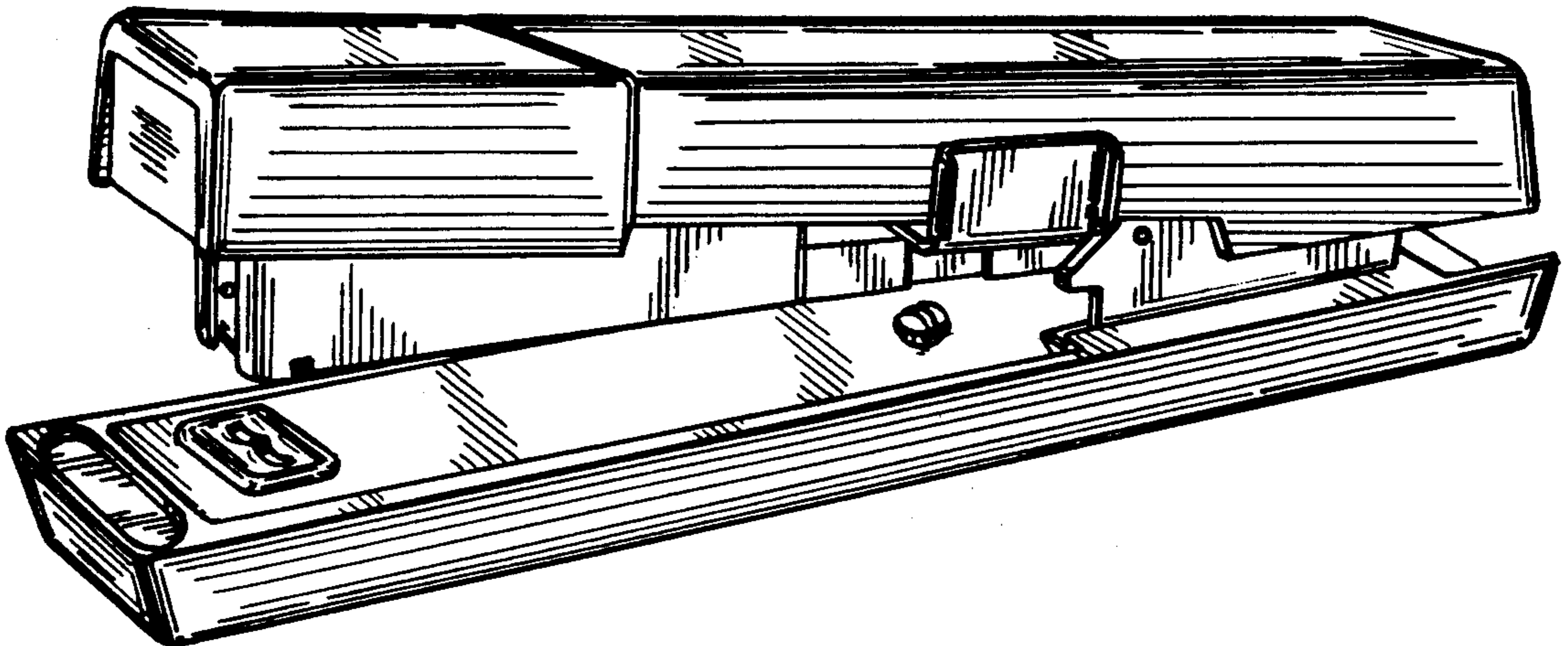

FIG. 1

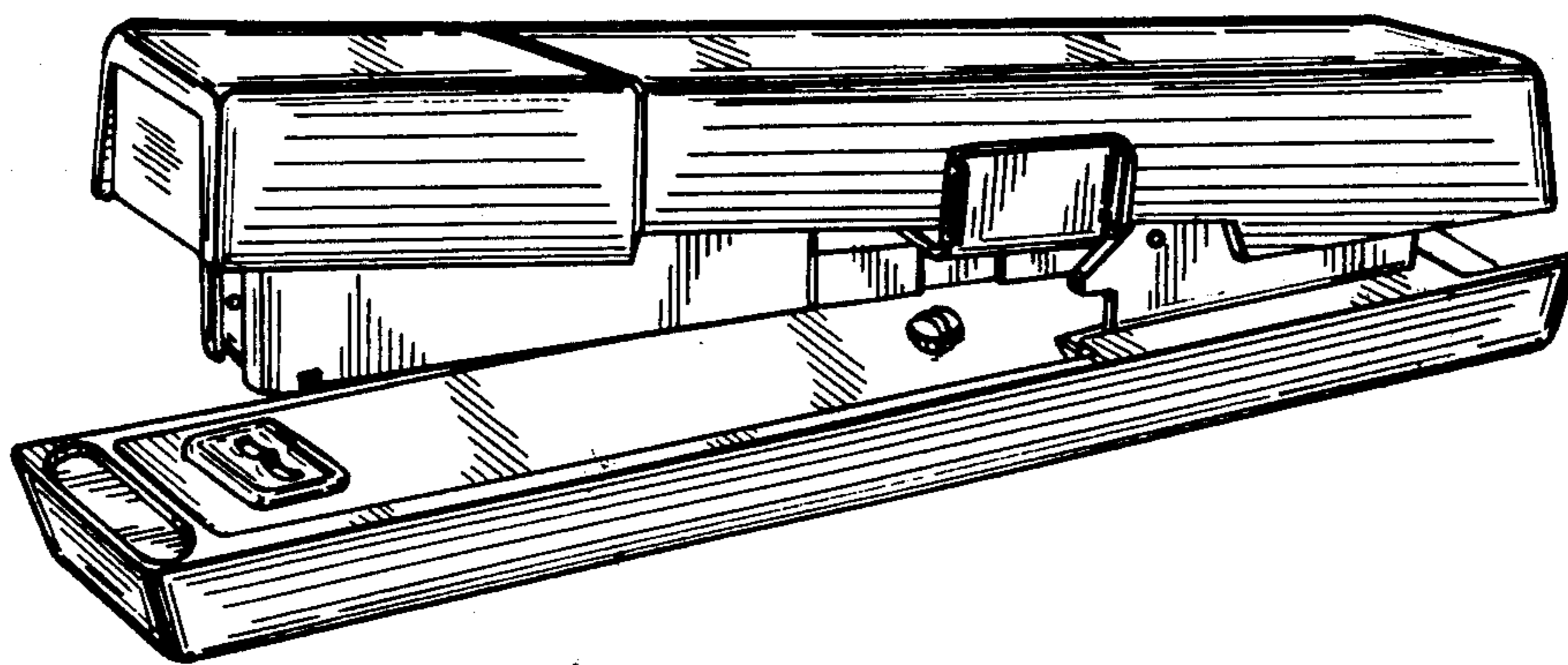

FIG. 2

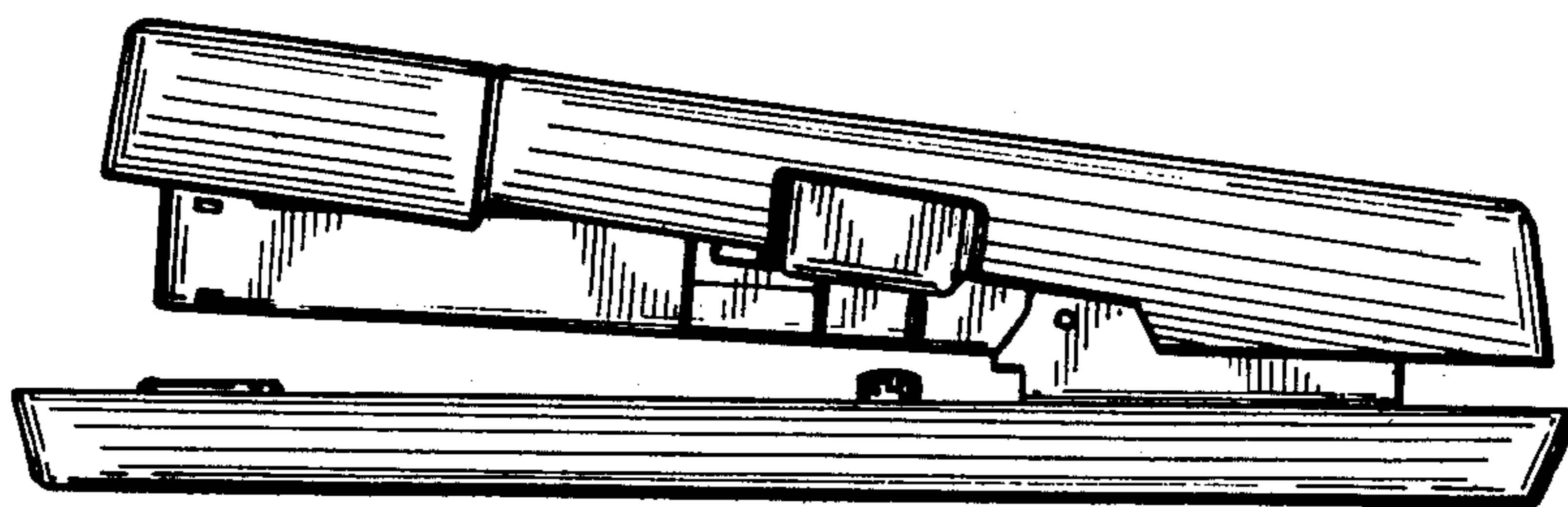

FIG. 3

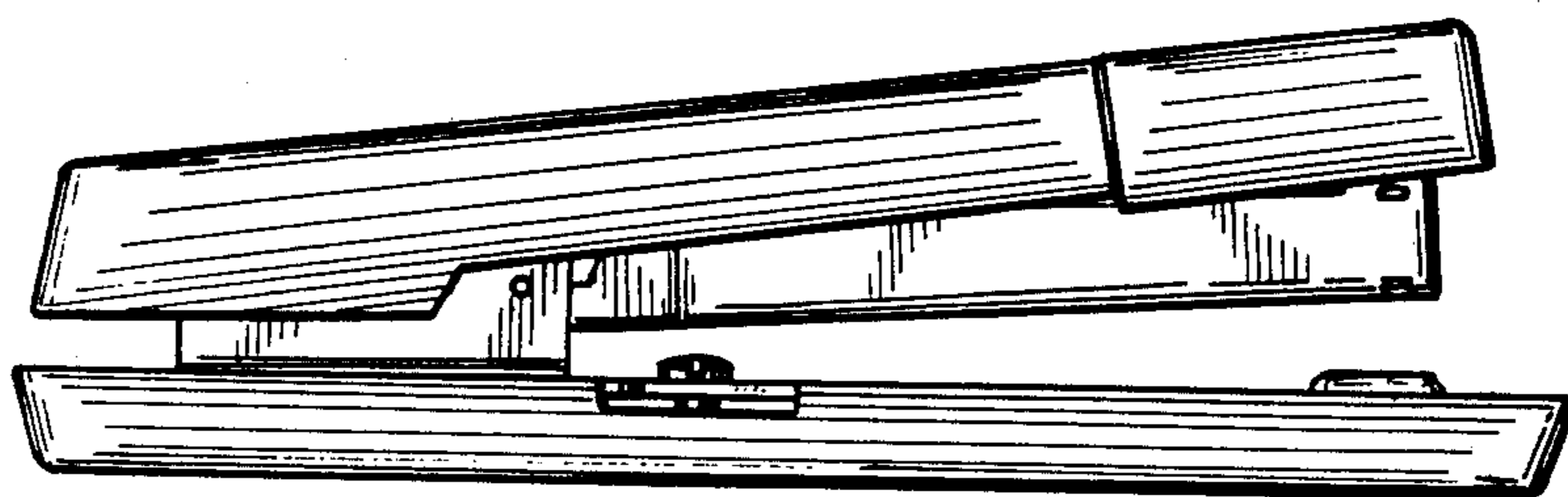

FIG. 4

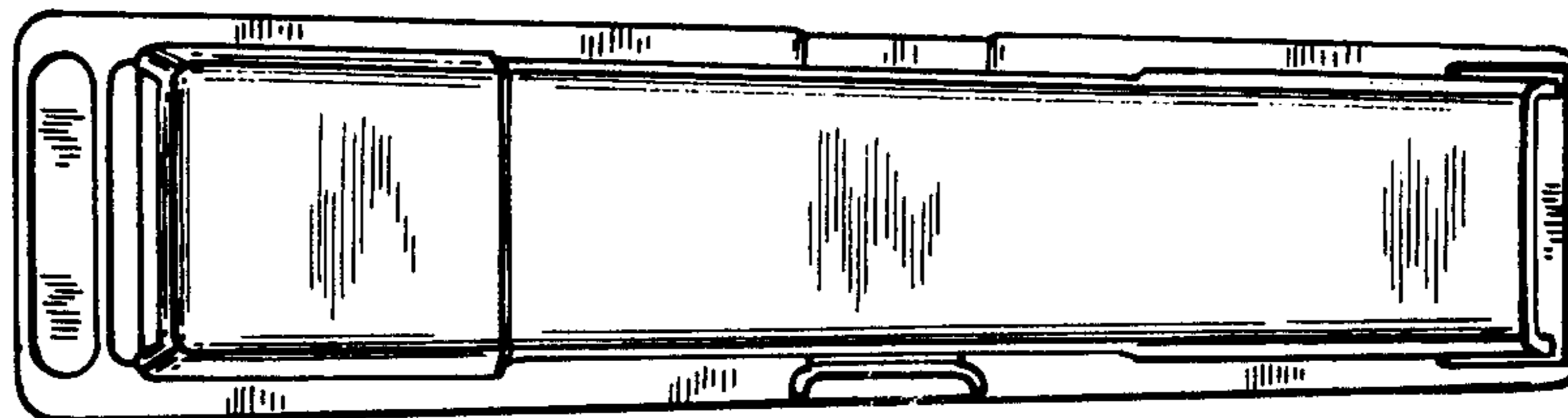

FIG. 5

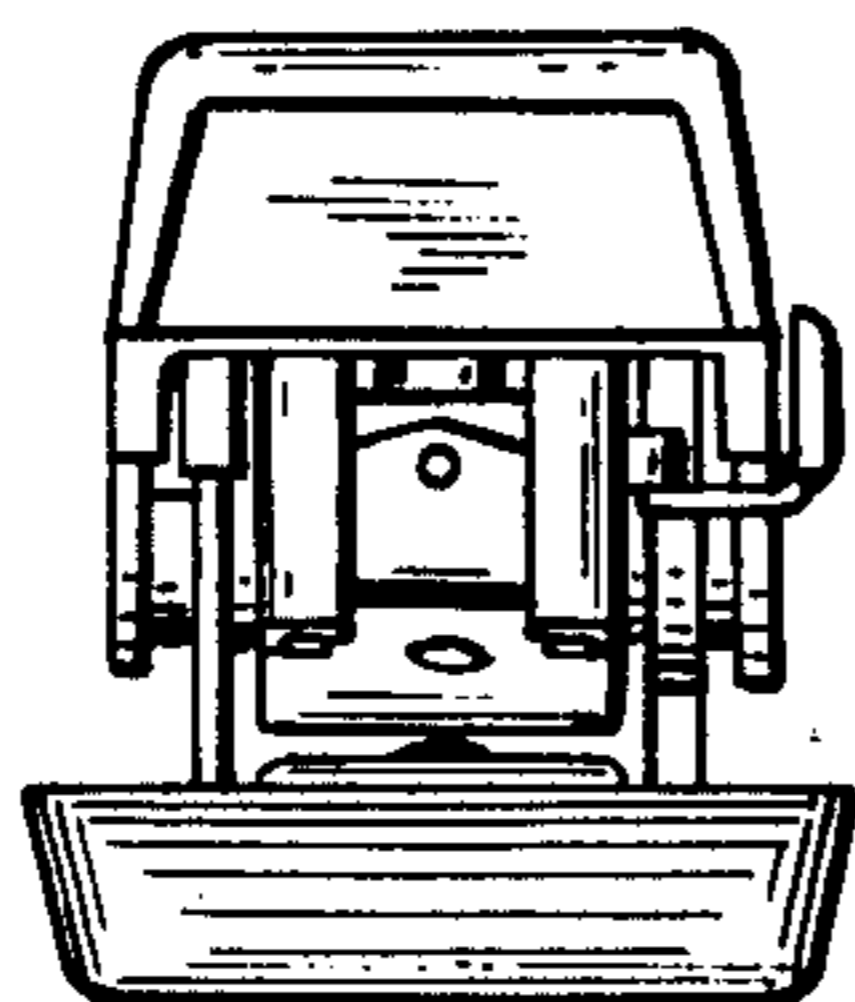

FIG. 6

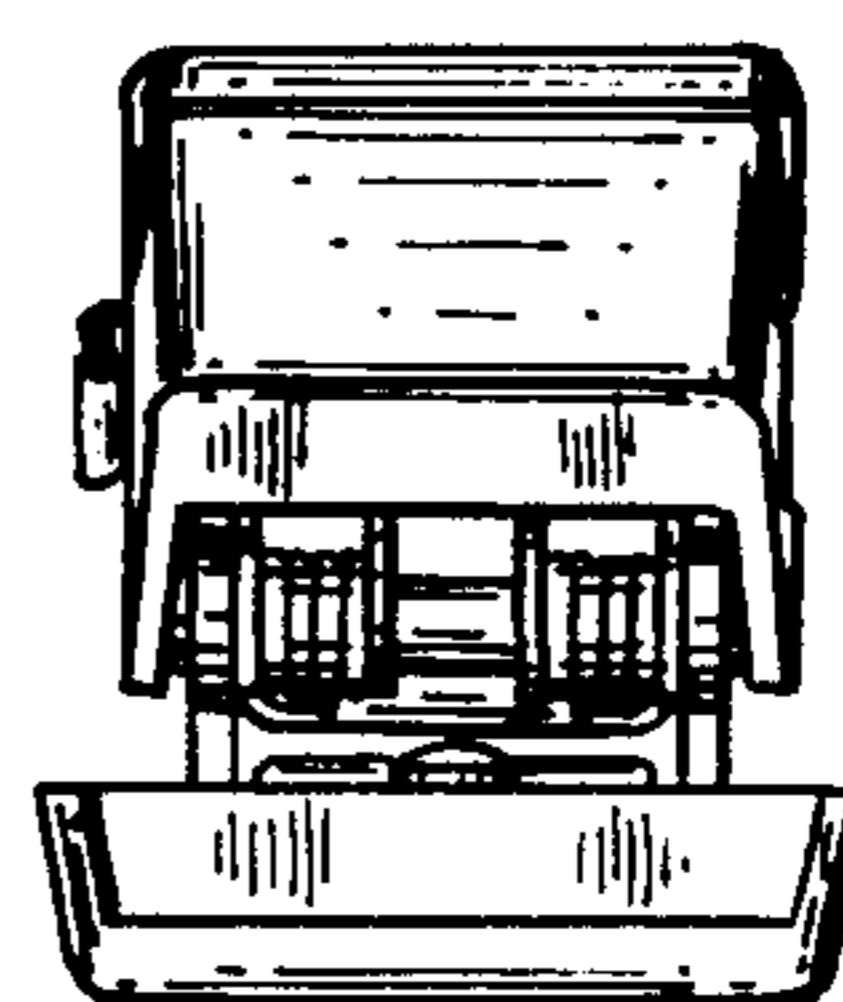

FIG. 7

