

[54] TABLE

[76] Inventor: William J. Schneider, 28128 Pacific Coast Hwy., Malibu, Calif. 90265

[**] Term: 14 Years

[21] Appl. No.: 817,835

[22] Filed: Jul. 21, 1977

[51] Int. Cl. D6-03

[52] U.S. Cl. D6/177

[58] Field of Search D6/20, 27, 85, 146-149, D6/151-154, 177, 178, 179, 192

[56] References Cited

U.S. PATENT DOCUMENTS

- D. 134,727 1/1943 Weber D6/177
- D. 175,110 7/1955 Howard D6/177 X
- D. 193,192 7/1962 Blevins D6/192

- D. 193,193 7/1962 Reineman et al. D6/177
- D. 240,184 6/1976 Nevschaefer D6/177 X
- D. 247,080 1/1978 Robinson D6/177

Primary Examiner—Bruce W. Dunkins
Attorney, Agent, or Firm—Ralph B. Pastoriza

[57] CLAIM

The ornamental design for a table, substantially as shown.

DESCRIPTION

FIG. 1 is a perspective view of a table showing my new design;
FIG. 2 is a top plan view thereof;
FIG. 3 is a bottom plan view thereof;
FIG. 4 is a front elevational view thereof;
FIG. 5 is a rear elevational view thereof;
FIG. 6 is a right end view thereof; and,
FIG. 7 is a left end view thereof.

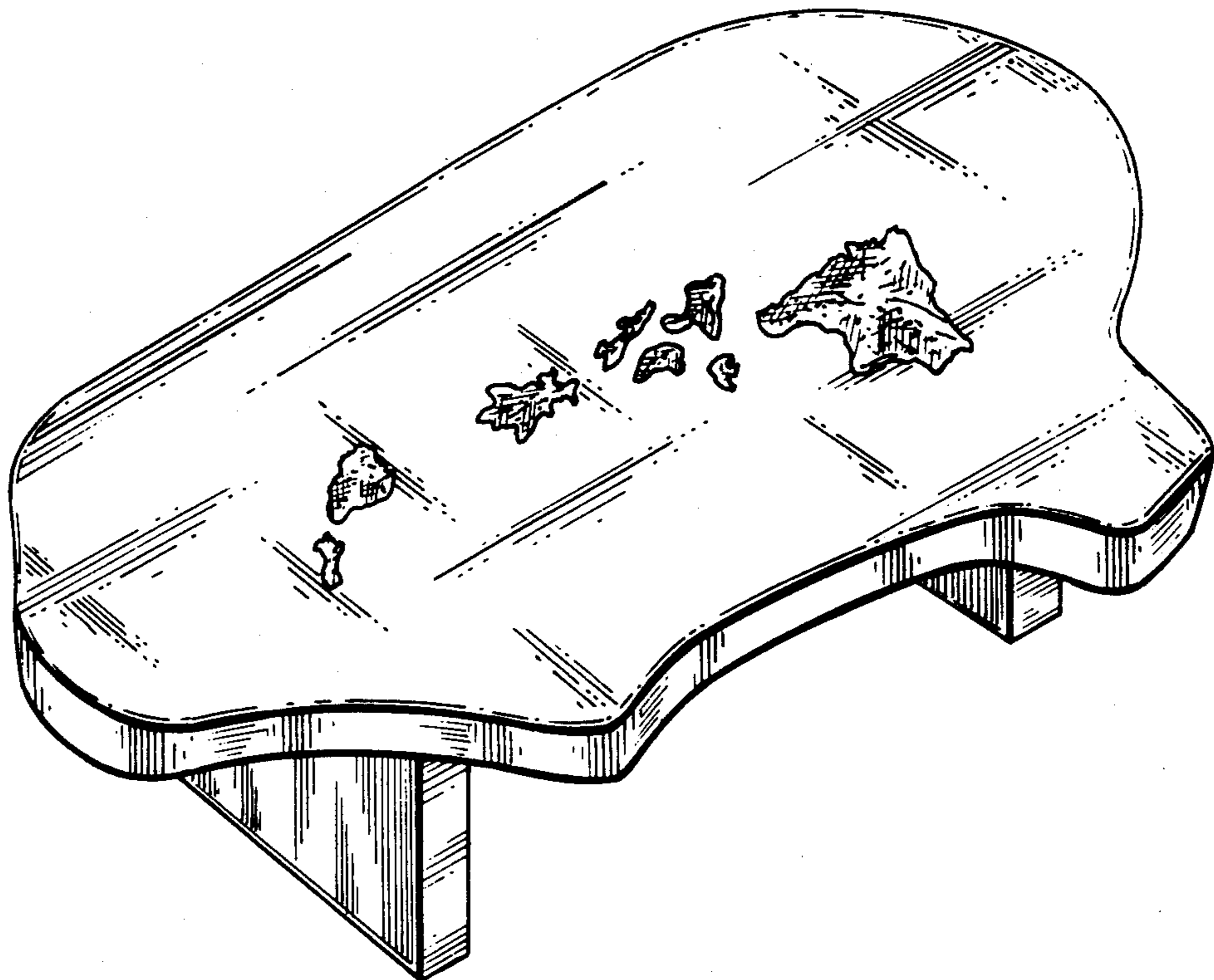

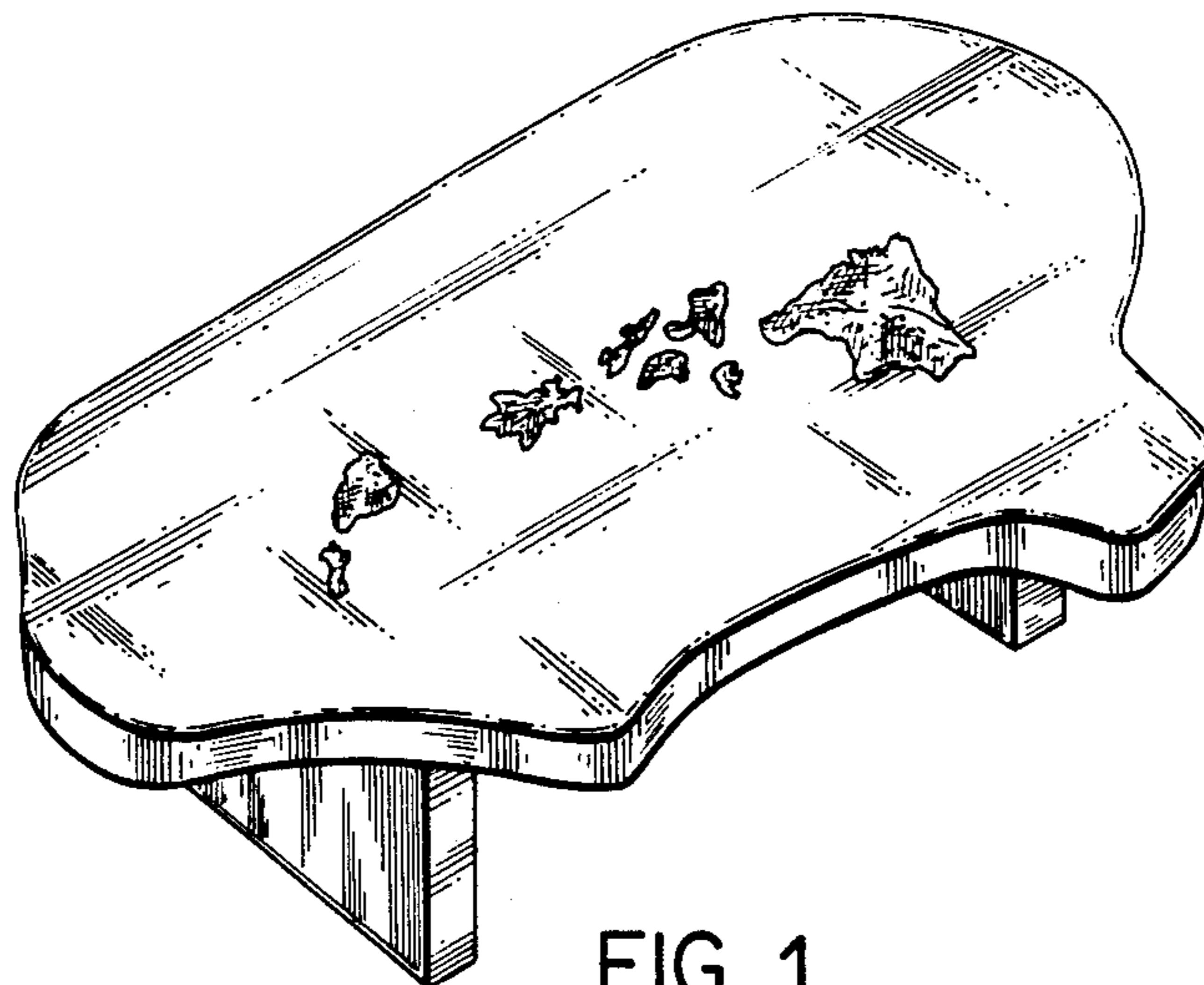

FIG. 1

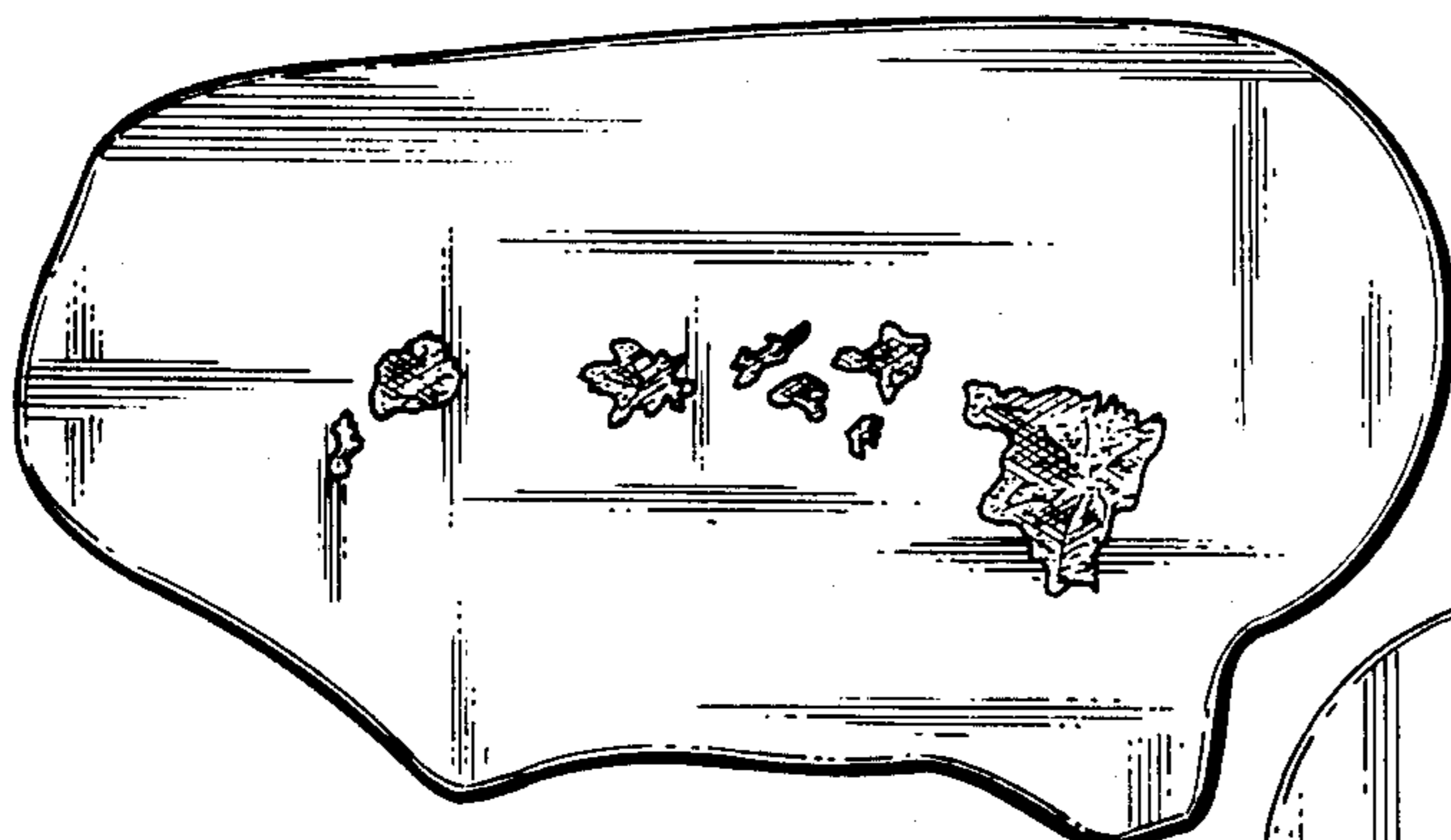

FIG. 2

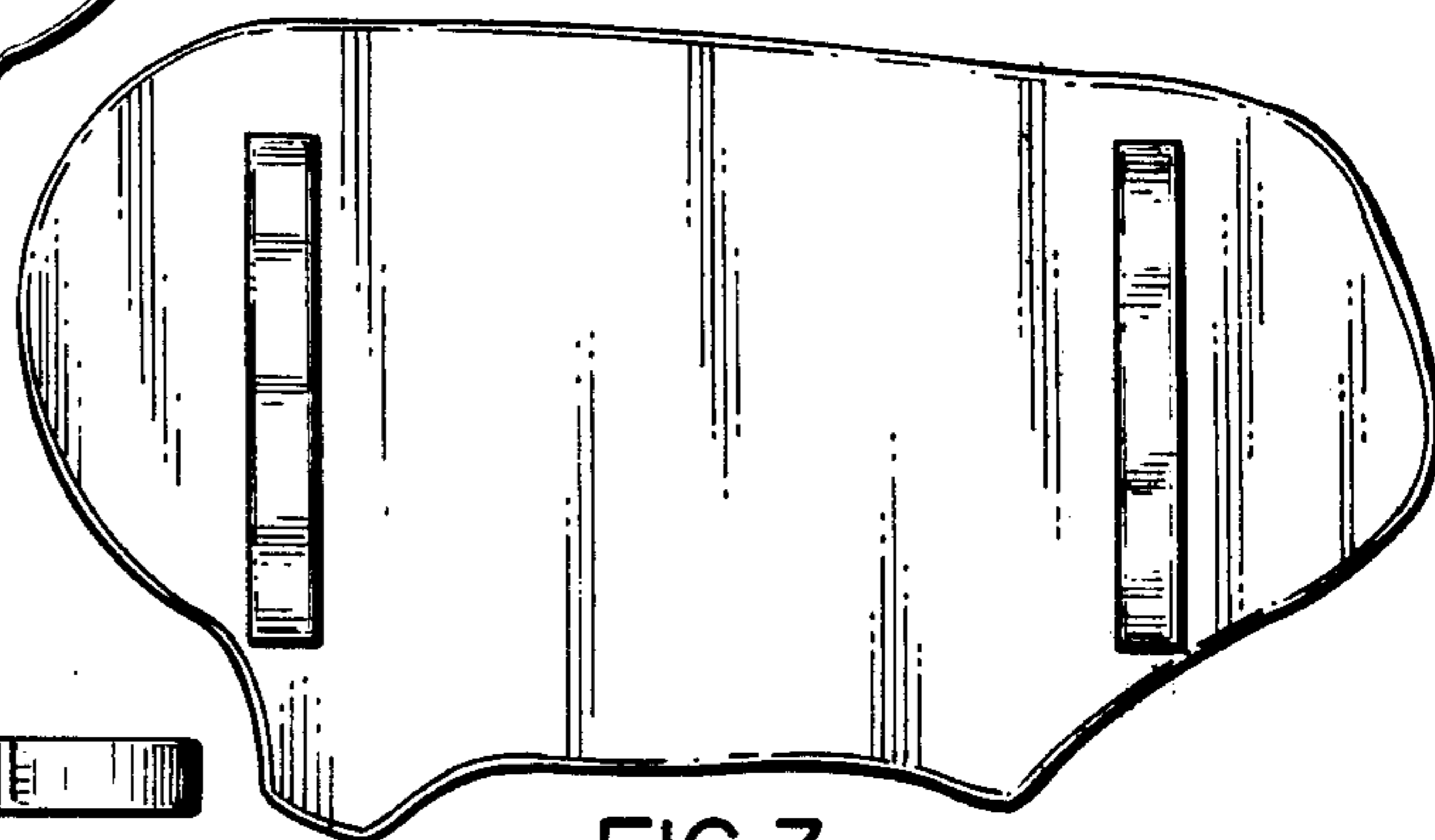

FIG. 3

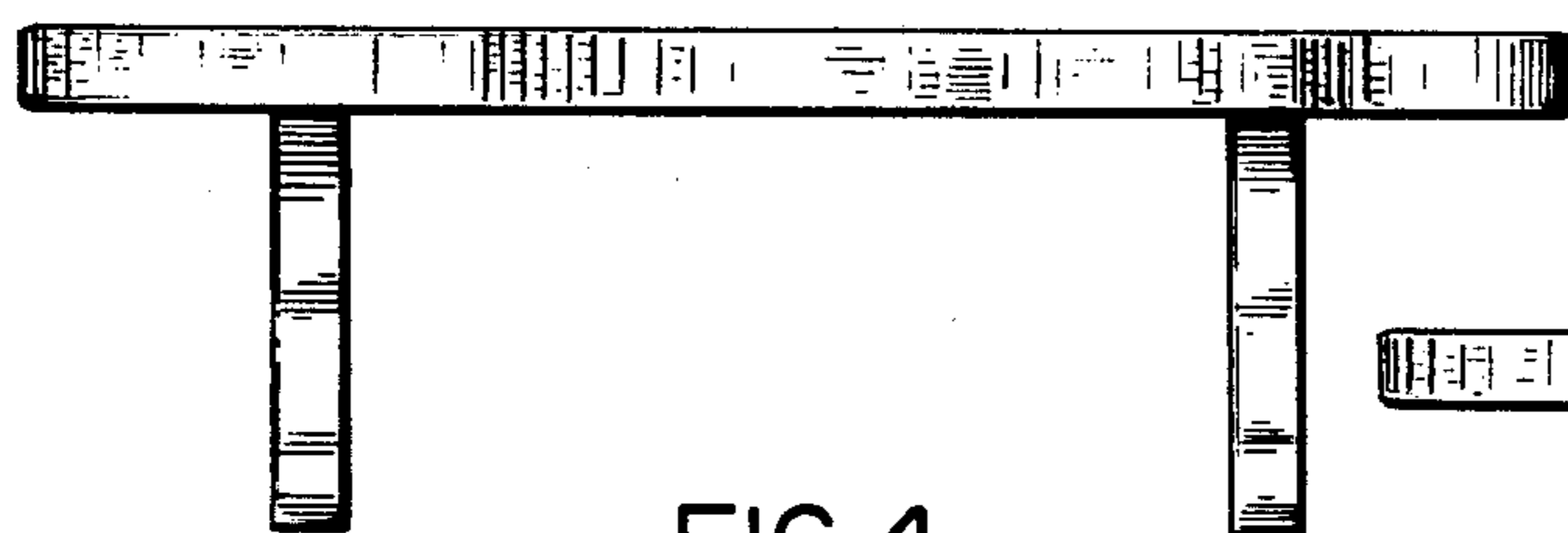

FIG. 4

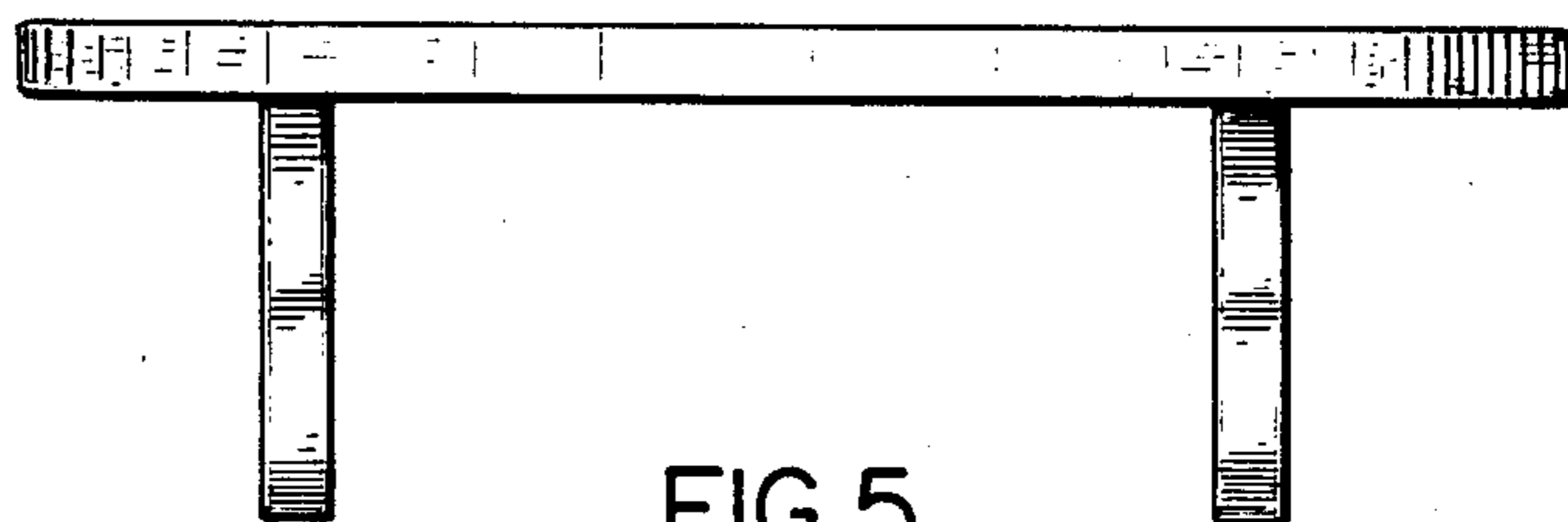

FIG. 5

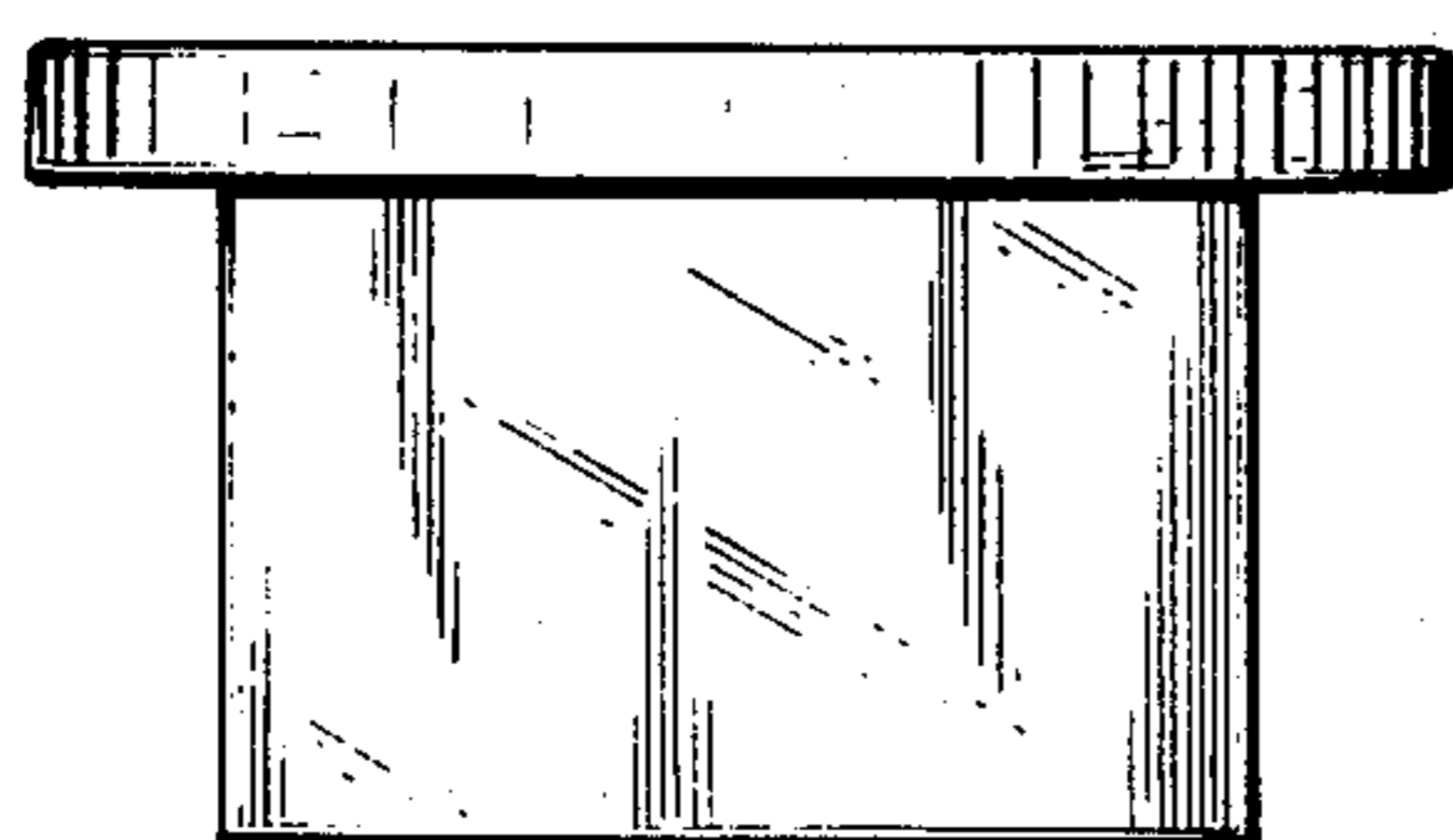

FIG. 6

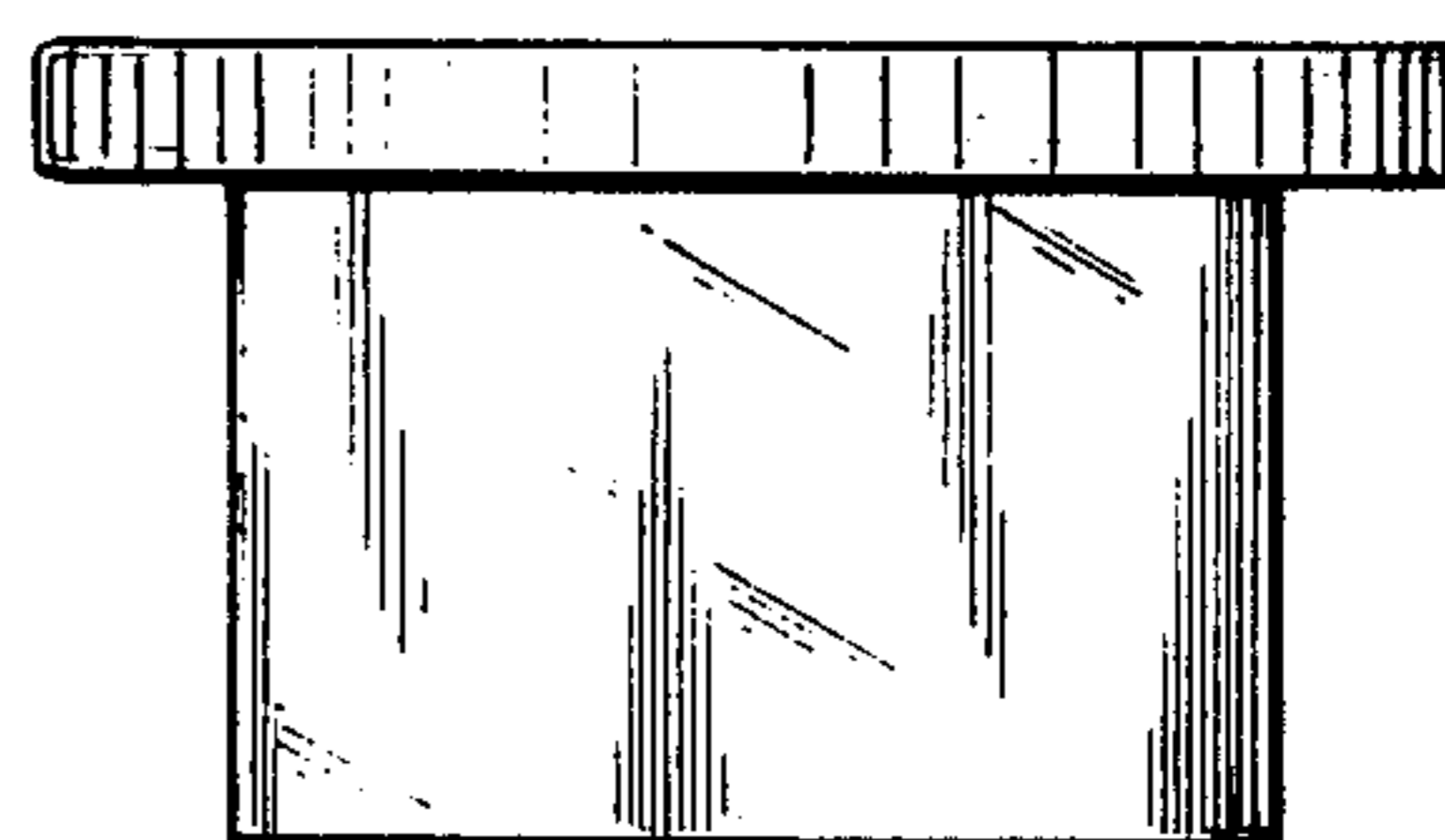

FIG. 7