

[54] WALL MOUNTED BRACKET ASSEMBLY
 [75] Inventor: Lee R. Chasen, Port Chester, N.Y.
 [73] Assignee: Coats & Clark, Inc., Stamford, Conn.
 [**] Term: 14 Years
 [21] Appl. No.: 734,265
 [22] Filed: Oct. 20, 1976

[51] Int. Cl. D6—06; D8—08
 [52] U.S. Cl. D6/114; D6/120;
 D6/137; D8/363; D8/373; D8/381
 [58] Field of Search D6/114, 120, 125, 137,
 D6/182, 183; D8/367, 380, 381, 363, 373;
 248/99, 163, 235, 311.1; 47/41 R, 41 G, 39, 40.5

[56] **References Cited**

U.S. PATENT DOCUMENTS

| | | | | |
|------------|---------|----------------|-------|--------|
| D. 70,831 | 8/1926 | Dlouhy | | D8/381 |
| D. 086,112 | 2/1932 | Dlouhy | | D8/363 |
| D. 162,413 | 3/1951 | Jorgensen | | D6/137 |
| D. 165,928 | 2/1952 | Parucki et al. | | D6/105 |
| D. 201,502 | 6/1965 | Nieman | | D8/381 |
| D. 202,354 | 9/1965 | Hentzl | | D8/381 |
| D. 238,036 | 12/1975 | Entin et al. | | D6/120 |
| D. 244,668 | 6/1977 | Tegner | | D8/367 |
| D. 245,832 | 9/1977 | Fredriksson | | D8/367 |
| D. 249,327 | 9/1978 | Gaines | | D8/373 |
| 2,504,583 | 4/1950 | Rachic | | 47/39 |

OTHER PUBLICATIONS

House Beautiful, 10/1959, p. 129, Thermometer Bracket.
 The Country Gourmet, 10/1974, p. 36, Hanging Bracket 7536.
 Garden Club Planter Pot Holders, 8/1975, p. 4, Bracket 5033.

Primary Examiner—Wallace R. Burke

Assistant Examiner—B. J. Bullock
 Attorney, Agent, or Firm—Milton J. Wayne

[57] **CLAIM**

The ornamental design for a wall mounted bracket assembly, substantially as shown and described.

DESCRIPTION

FIG. 1 is a reduced perspective view of a wall mounted bracket assembly showing my new design;
 FIG. 2 is a reduced side view of a second embodiment of the design of FIG. 1, the only difference being the reversal of the projecting arm;
 FIG. 3 is a rear view of FIG. 1;
 FIG. 4 is a side view of the mounting plate, shown separately for ease of illustration;
 FIG. 5 is a front view of FIG. 4;
 FIG. 6 is a top view of FIG. 4;
 FIG. 7 is a sectional view taken on line 7—7 of FIG. 4;
 FIG. 8 is a bottom view of FIG. 4;
 FIG. 9 is a top view of FIG. 1, the hook being omitted for convenience of illustration;
 FIG. 10 is a side view of FIG. 9;
 FIG. 11 is a partial side view of a third embodiment of the design of FIG. 1, the only difference being the configuration of the termination of the projecting arm;
 FIG. 12 is a bottom view of FIG. 9;
 FIG. 13 is a front view of the projecting arm shown separately for ease of illustration;
 FIG. 14 is a rear view of FIG. 13;
 FIG. 15 is an enlarged side view of the hook, also shown separately for ease of illustration;
 FIG. 16 is a front view of FIG. 15;
 FIG. 17 is a rear view of FIG. 15;
 FIG. 18 is a top view of FIG. 15;
 FIG. 19 is a bottom view of FIG. 15;
 FIG. 20 is a sectional view taken on line 20—20 of FIG. 15.

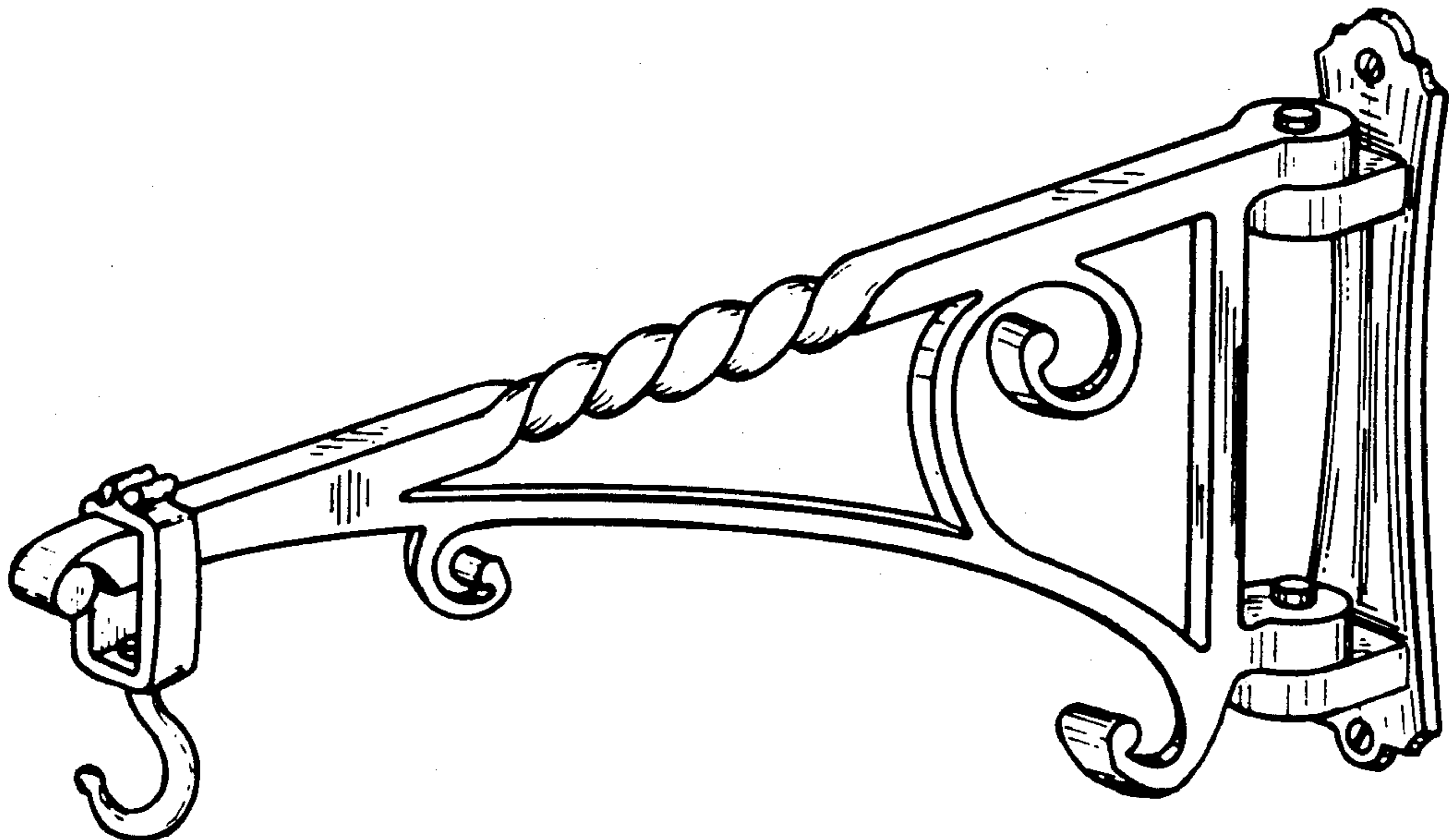

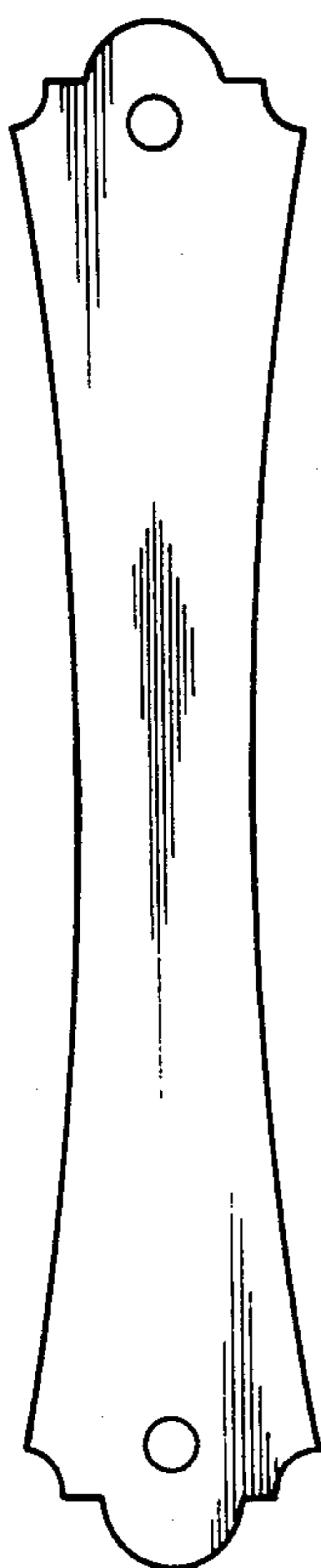
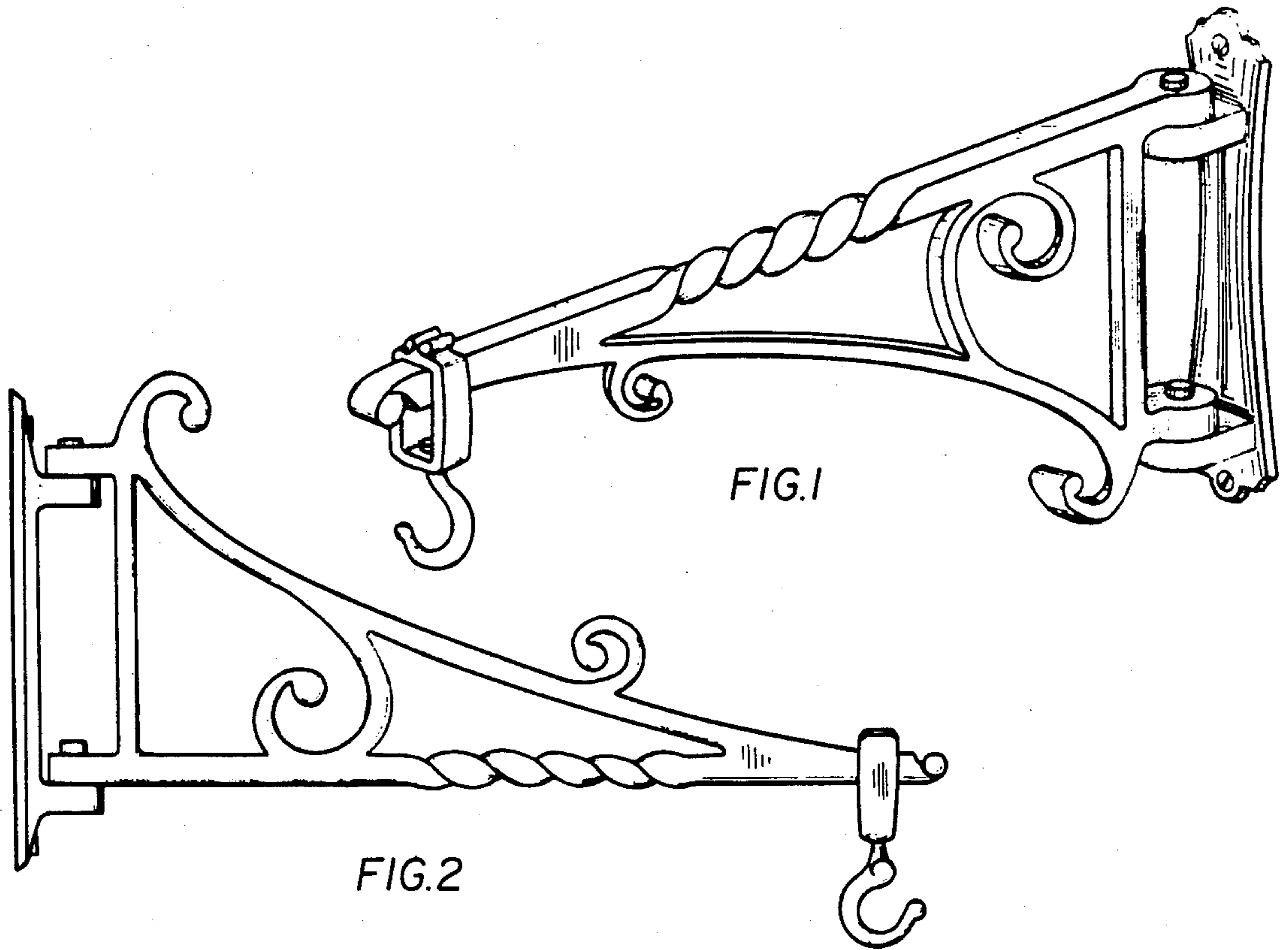

FIG. 3

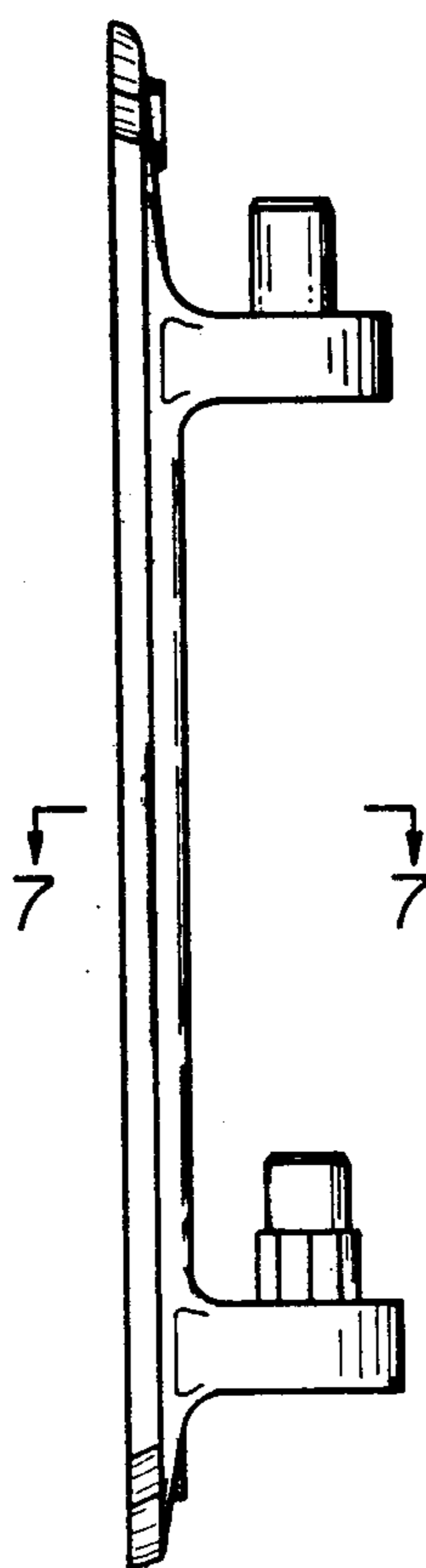

FIG. 4

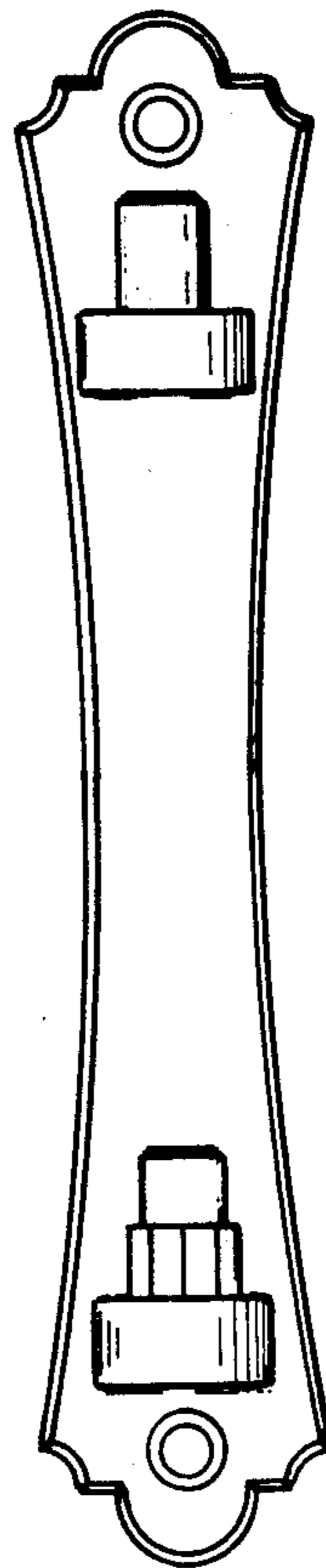

FIG. 5

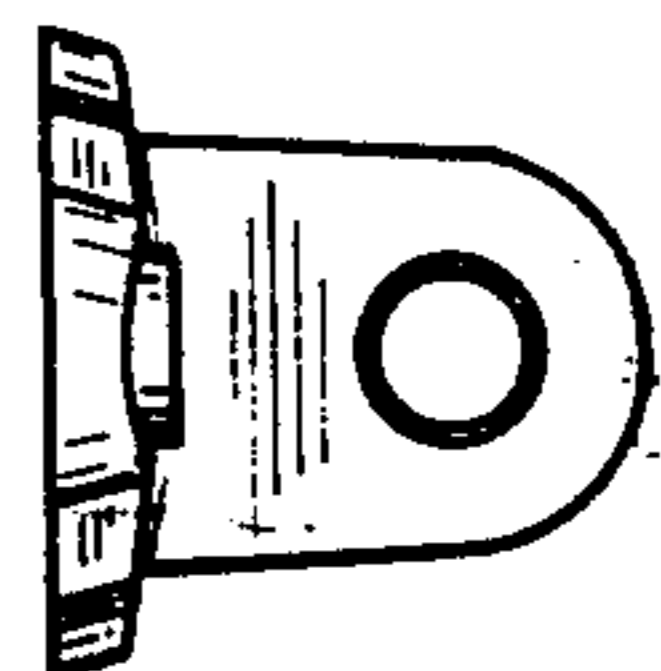

FIG. 6

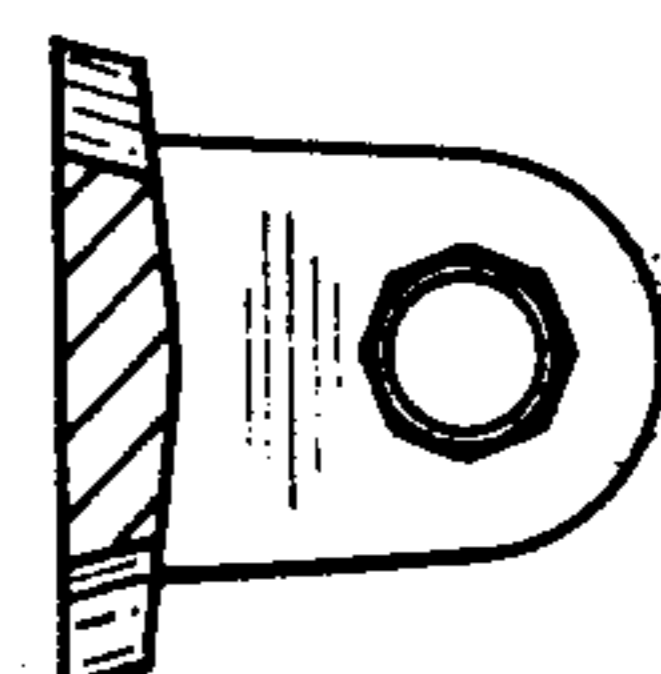

FIG. 7

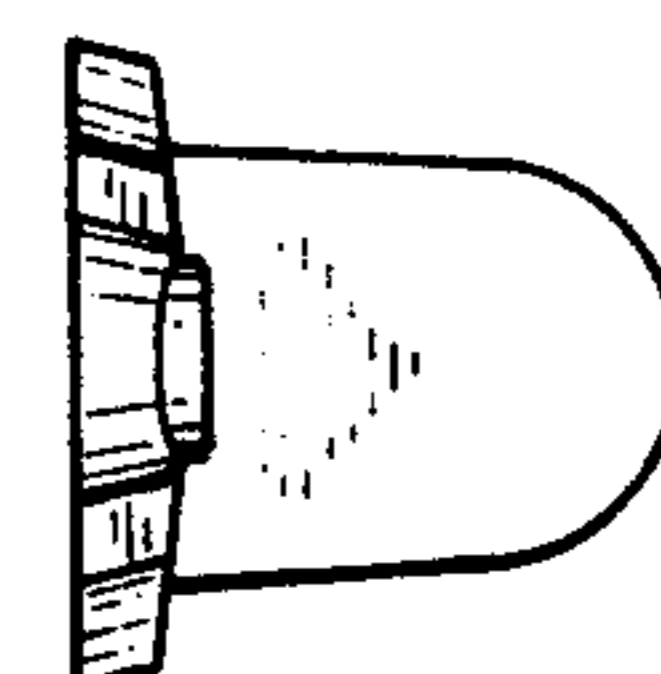

FIG. 8

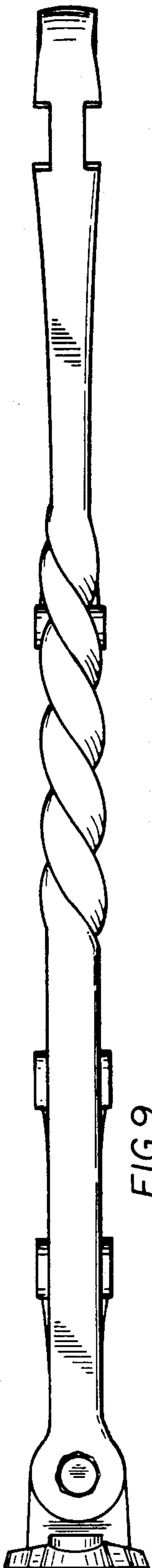

FIG. 9

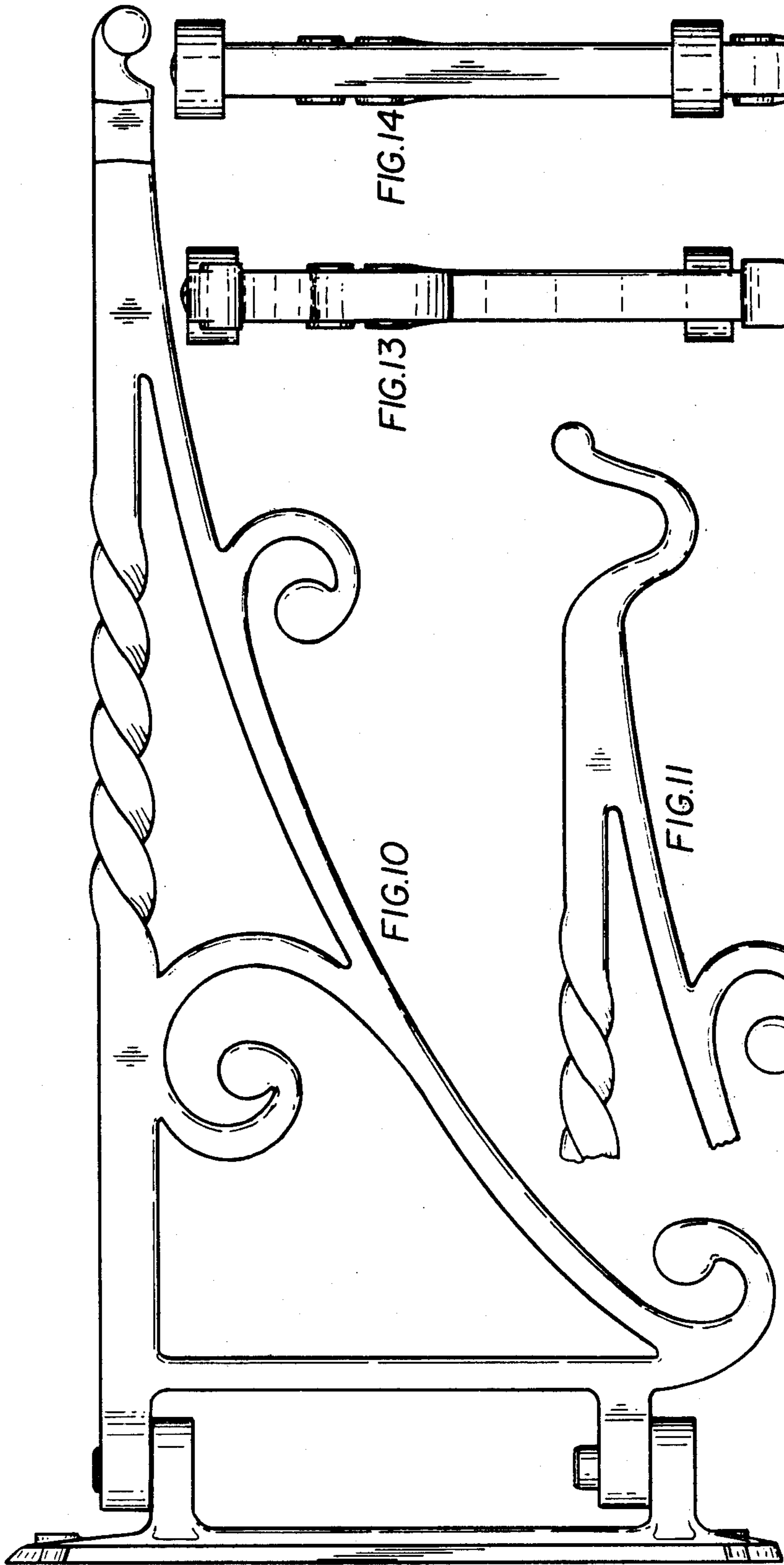

FIG. 10

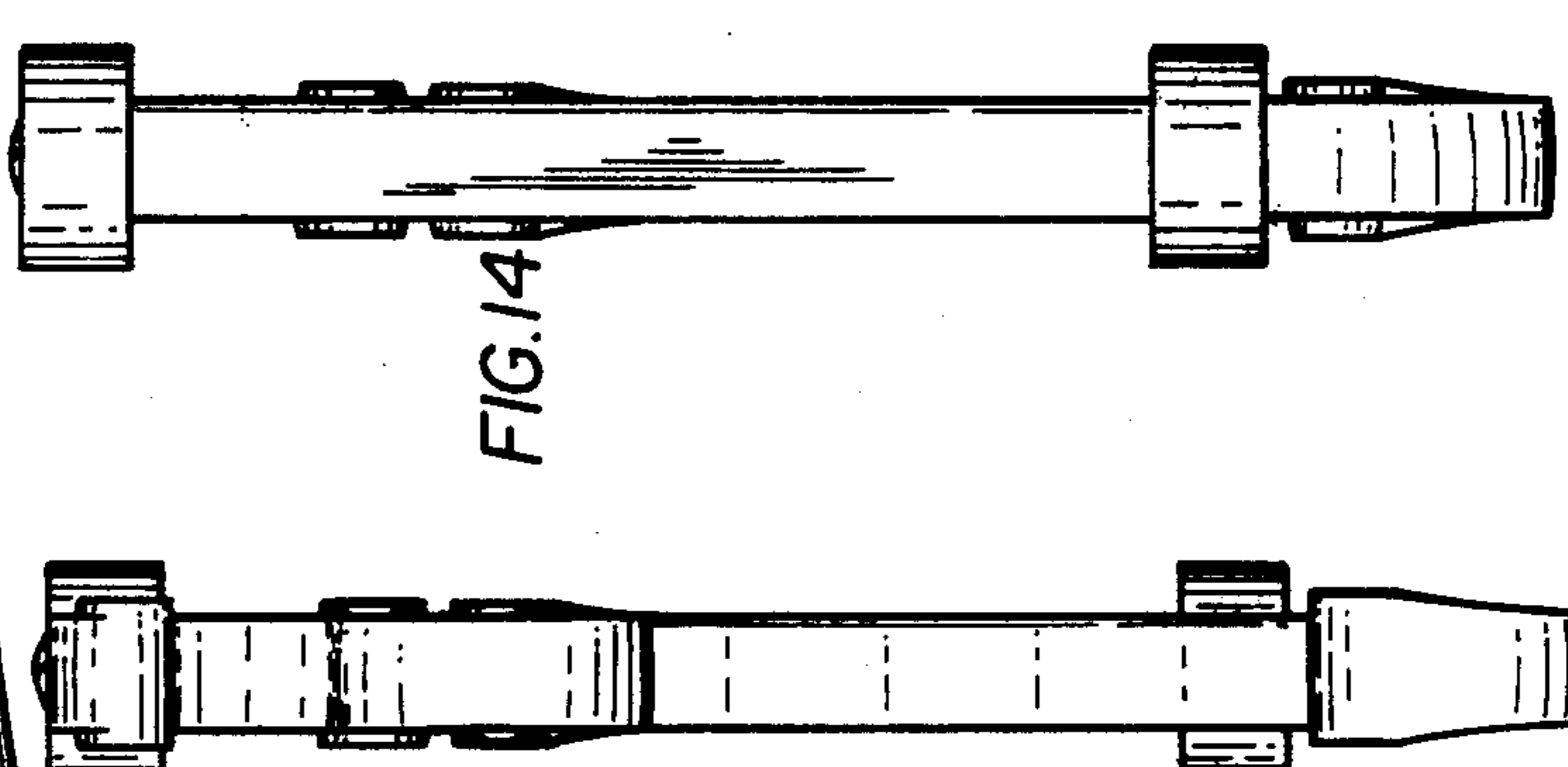

FIG. 13

FIG. 14

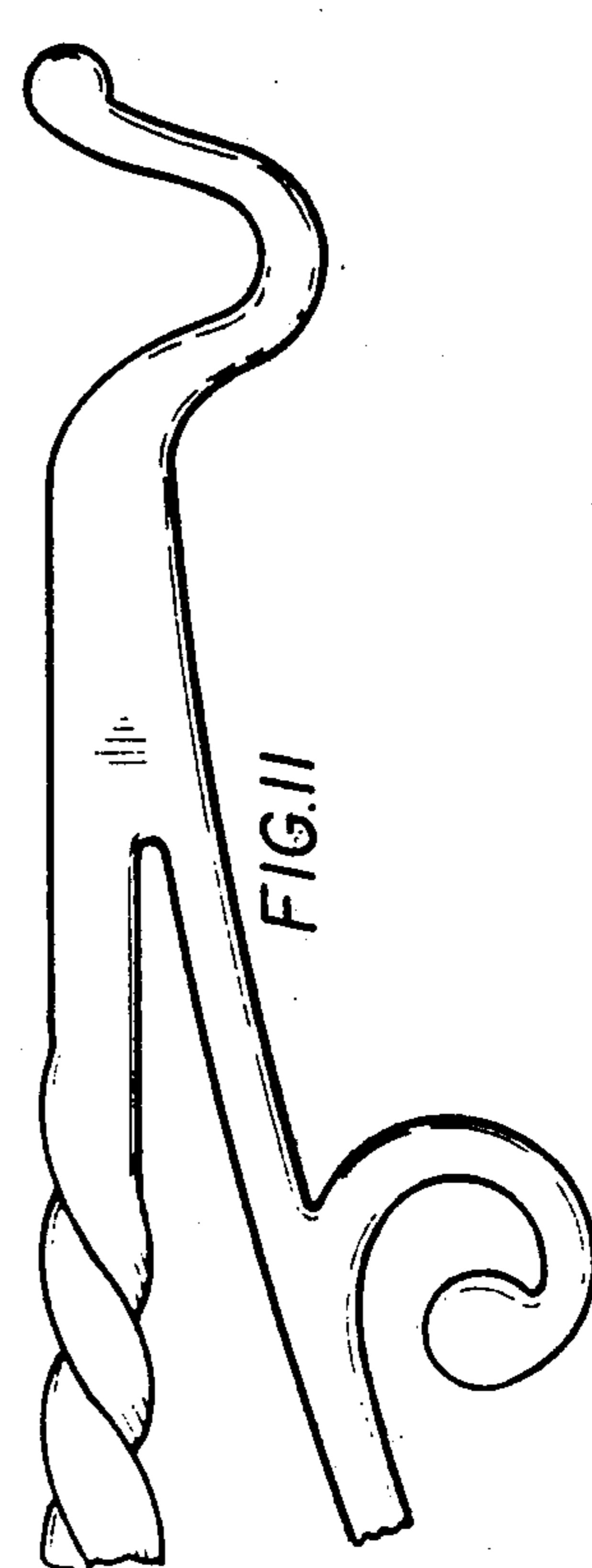

FIG. 11



FIG. 12

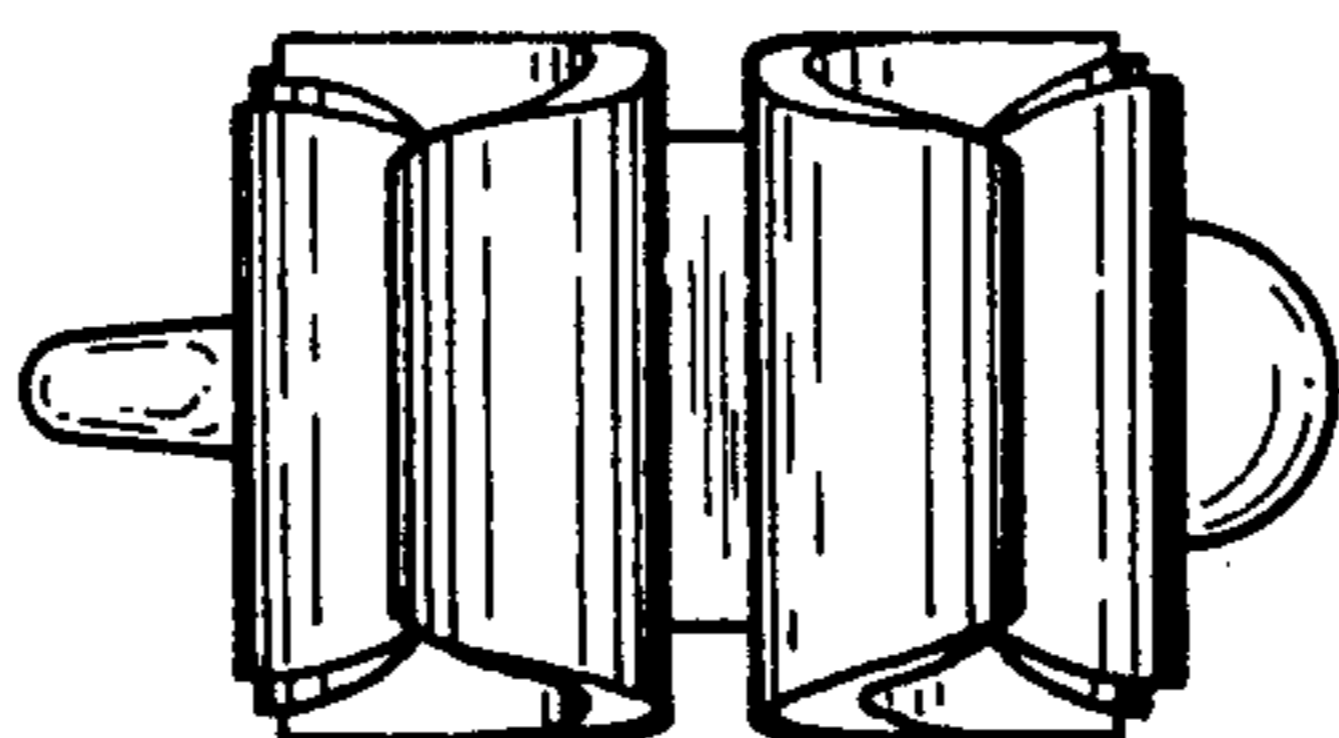

FIG. 18

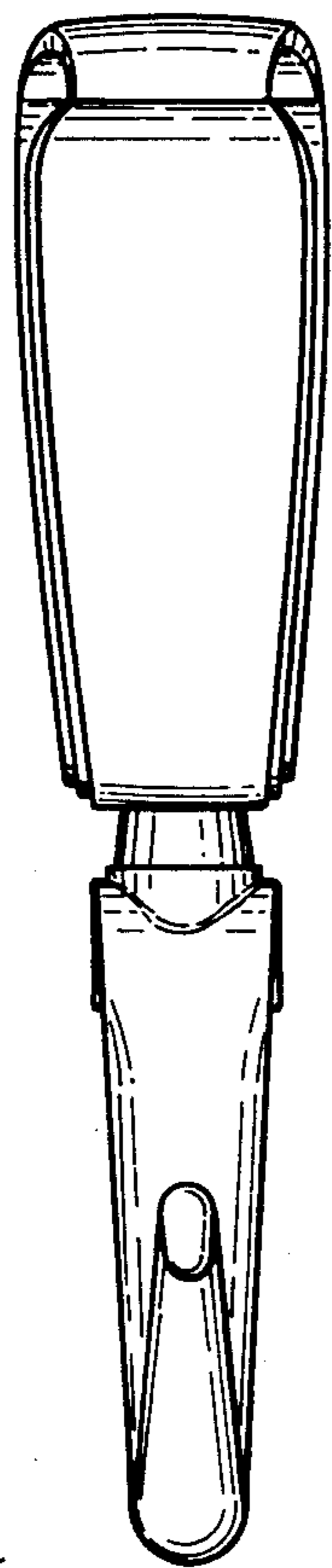

FIG. 16

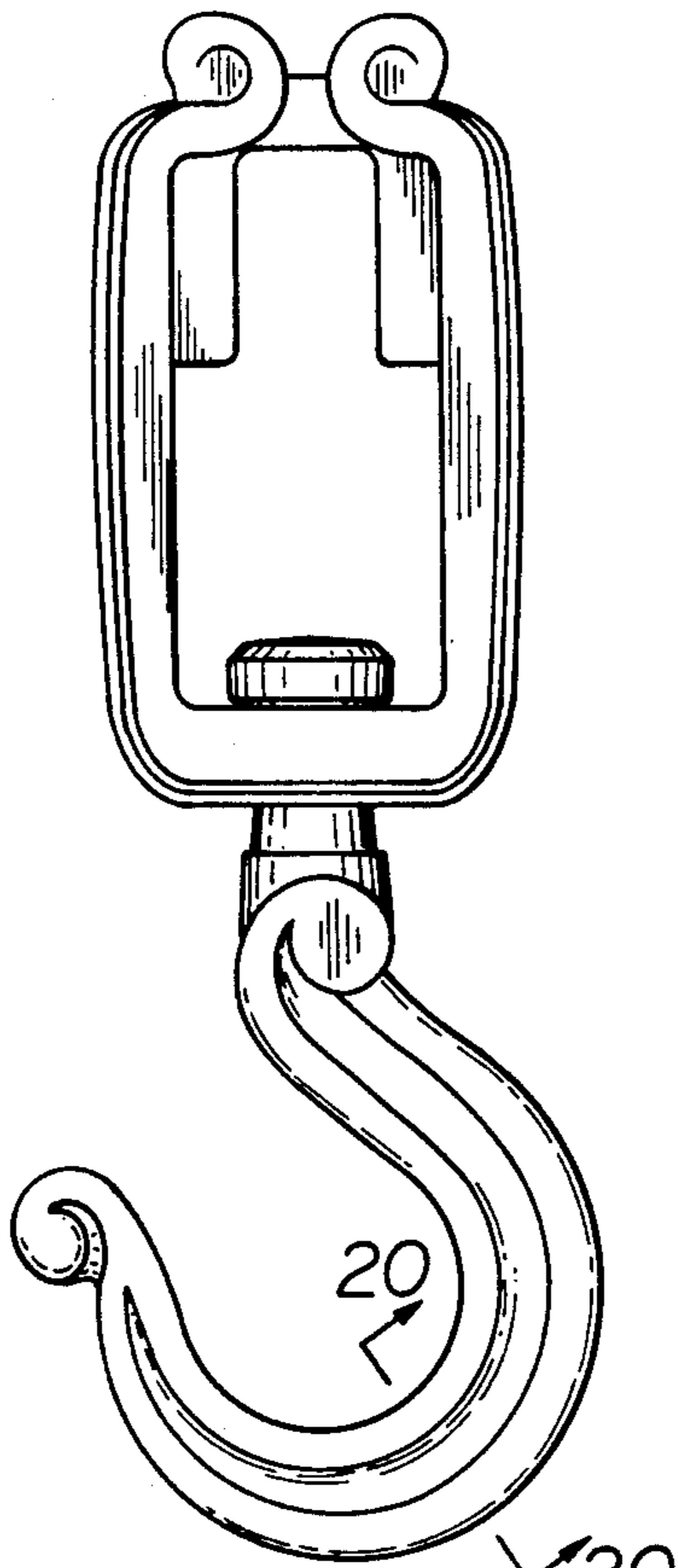

FIG. 15

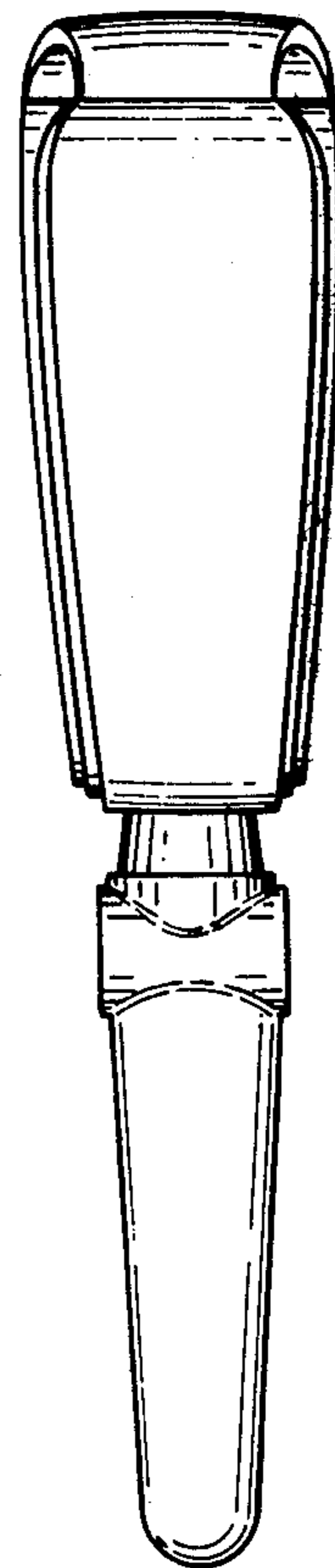

FIG. 17



FIG. 20

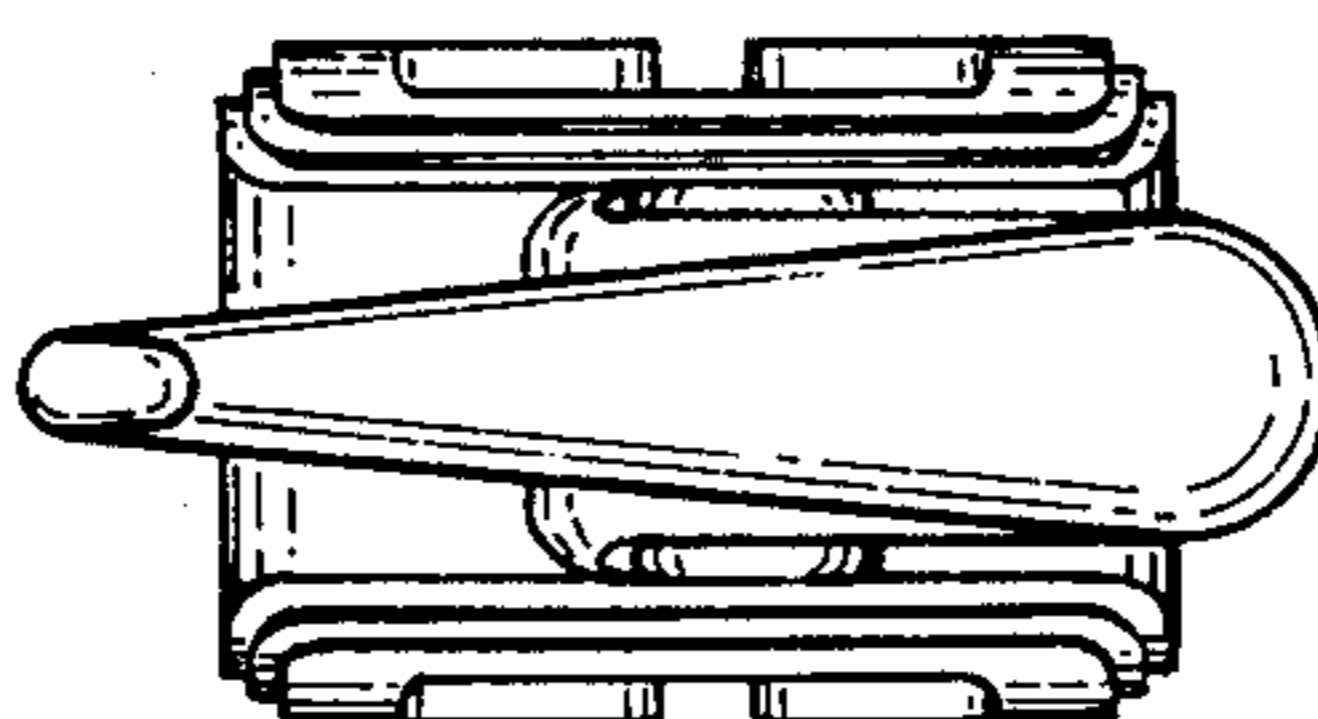

FIG. 19