

- [54] **ELECTRIC BEVERAGE MAKER**
- [75] Inventor: **Tatsuo Okazaki, Kamifukuoka, Japan**
- [73] Assignee: **Kabushikigaisha Omco, Oimachi, Japan**
- [**] Term: **14 Years**
- [21] Appl. No.: **744,685**
- [22] Filed: **Nov. 24, 1976**
- [30] **Foreign Application Priority Data**
 Sep. 13, 1976 [JP] Japan 51-36198
- [51] Int. Cl. **D7-02**
- [52] U.S. Cl. **D7/62; D7/65**
- [58] Field of Search **D7/9, 41, 50, 59, 60, D7/61, 62, 63, 64, 65, 66, 67, 51**
- [56] **References Cited**
U.S. PATENT DOCUMENTS
 D. 97,663 12/1935 Ackerman D7/67

D. 97,979	12/1935	Ackerman	D7/51
D. 100,700	8/1936	Kornblum	D7/51
D. 192,642	4/1962	Douglas	D7/65
D. 227,143	6/1973	Haynes	D7/63

OTHER PUBLICATIONS

Tableware International, Apr. 1971, p. 36, Vacuum Jug by Robert Welch, left column, r. item.

Primary Examiner—Winifred E. Herrmann
Attorney, Agent, or Firm—Robert D. Flynn

[57] **CLAIM**

The ornamental design for an electric beverage maker, as shown.

DESCRIPTION

FIG. 1 is a perspective view of an electric beverage maker showing my design;
 FIG. 2 is a top plan view thereof;
 FIG. 3 is a bottom plan view thereof;
 FIG. 4 is a front elevational view thereof;
 FIG. 5 is a rear elevational view thereof;
 FIG. 6 is a left side elevational view thereof; and
 FIG. 7 is a right side elevational view thereof.

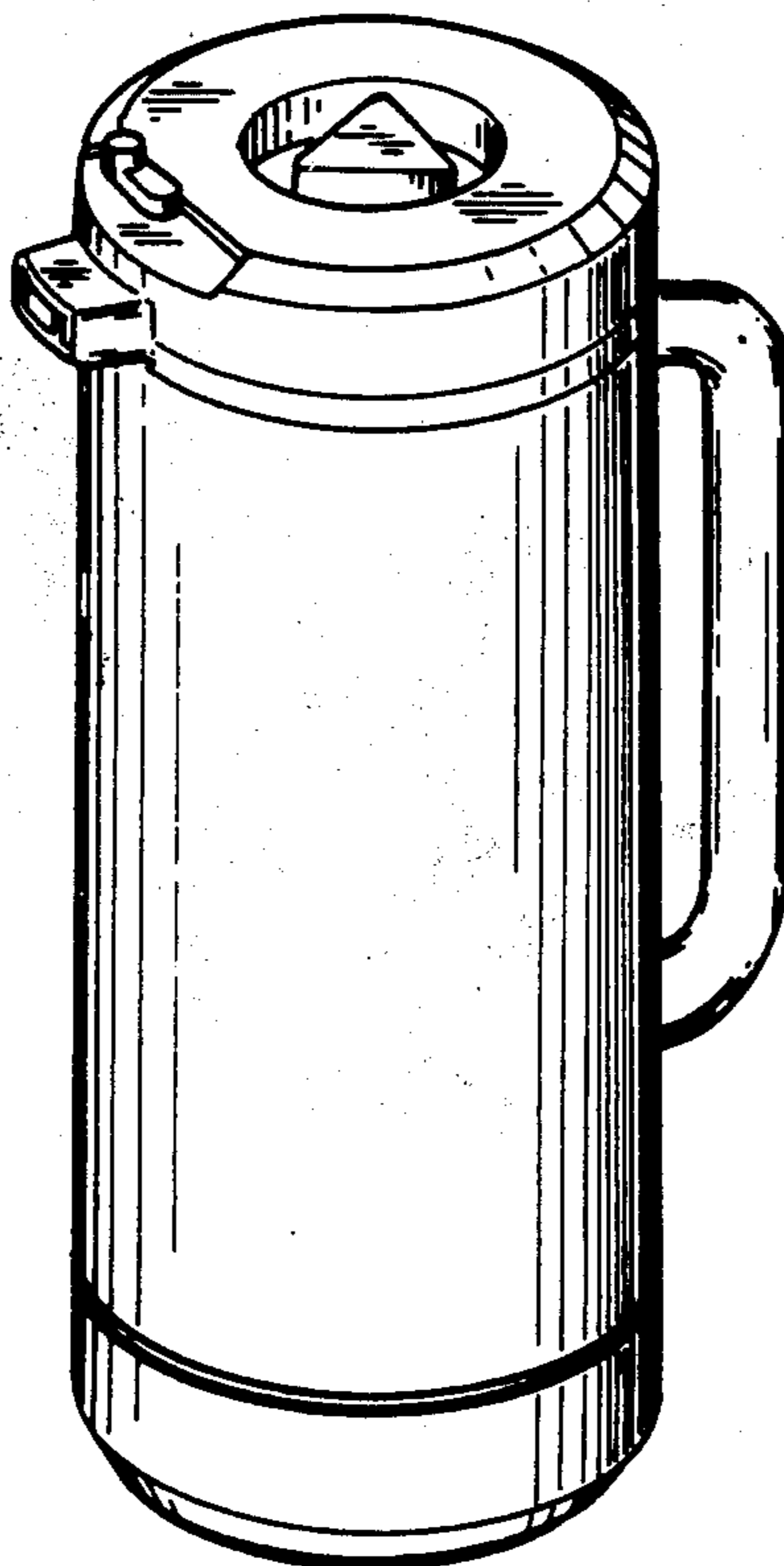

FIG. 6

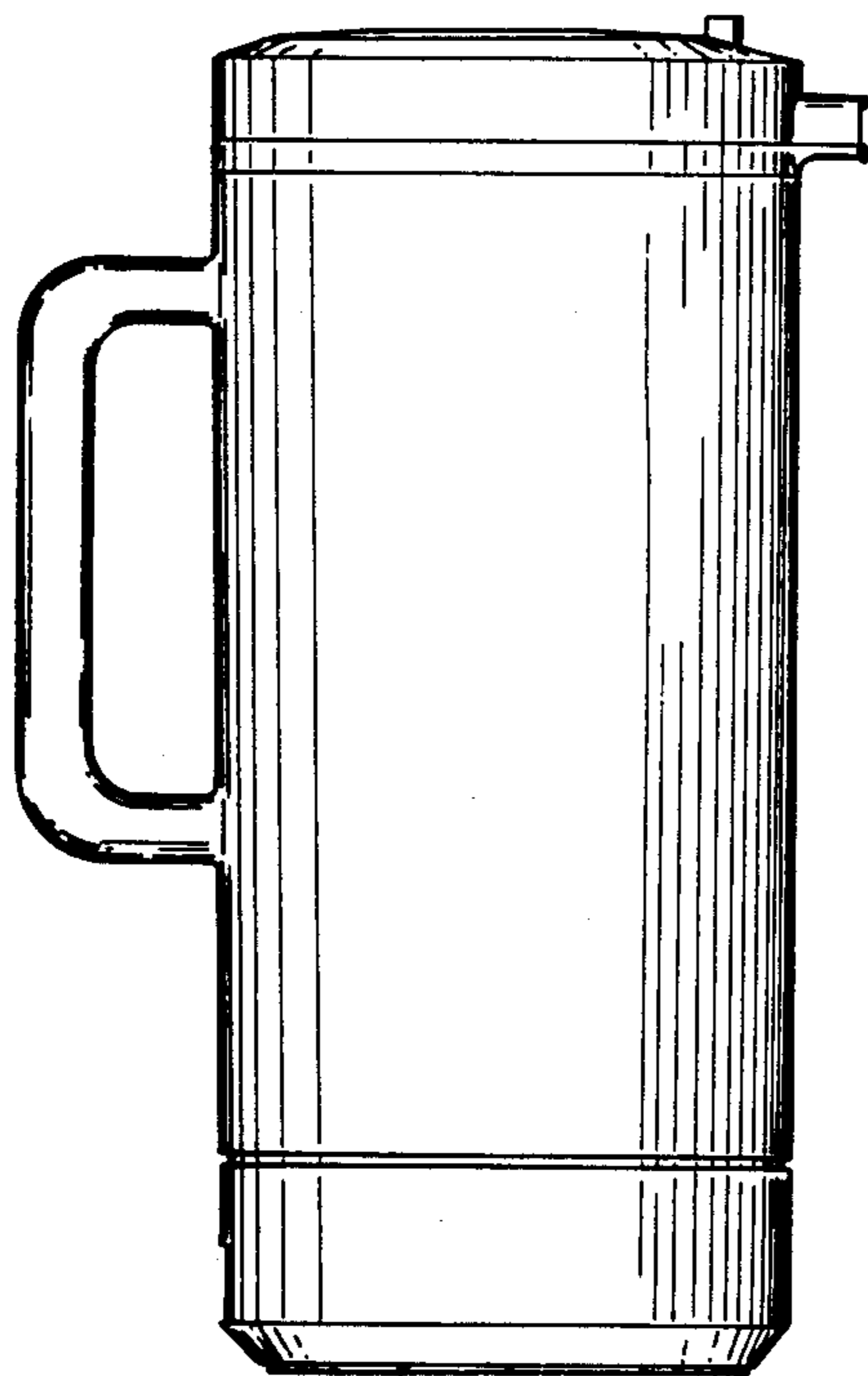

FIG. 7

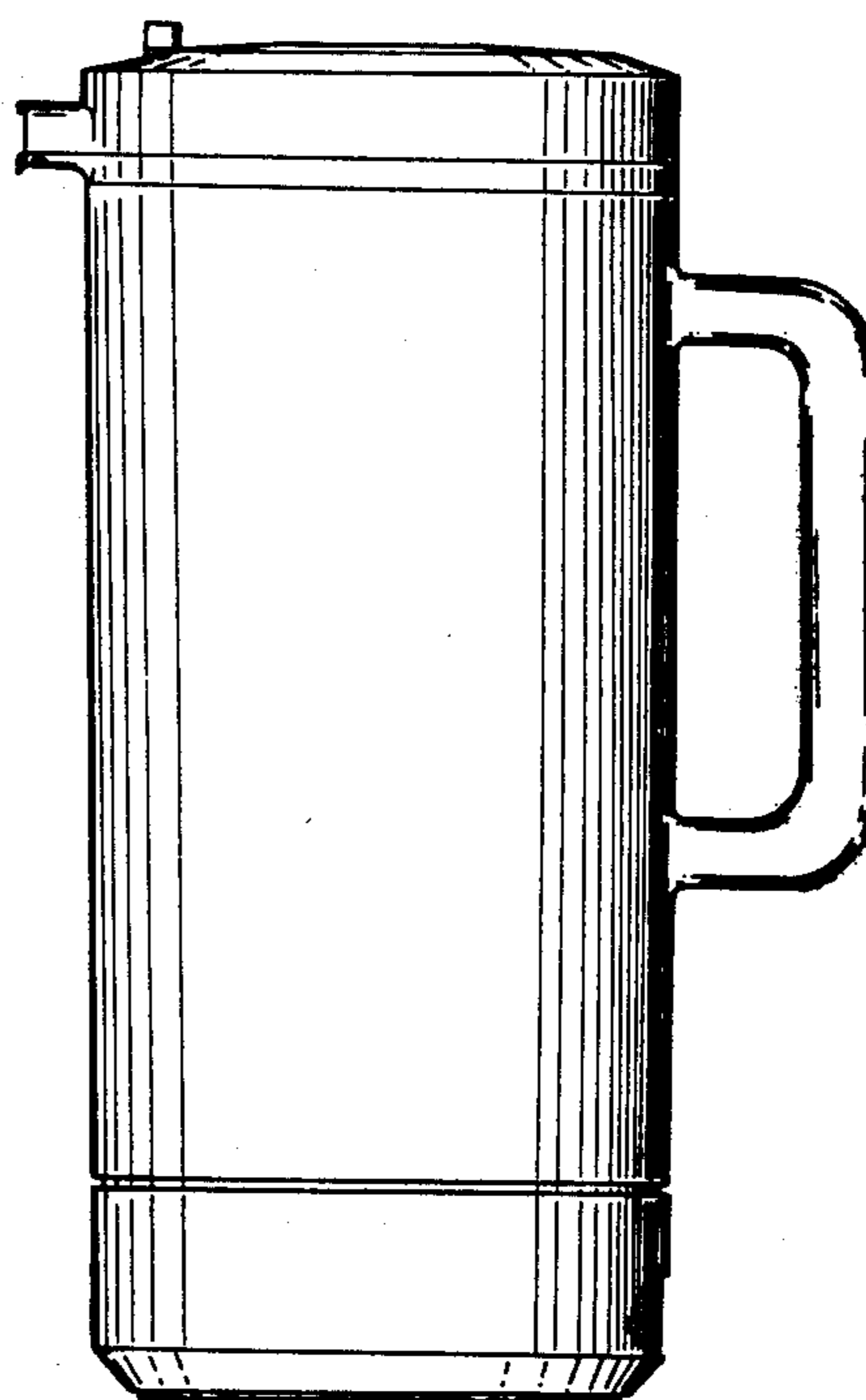

FIG. 1

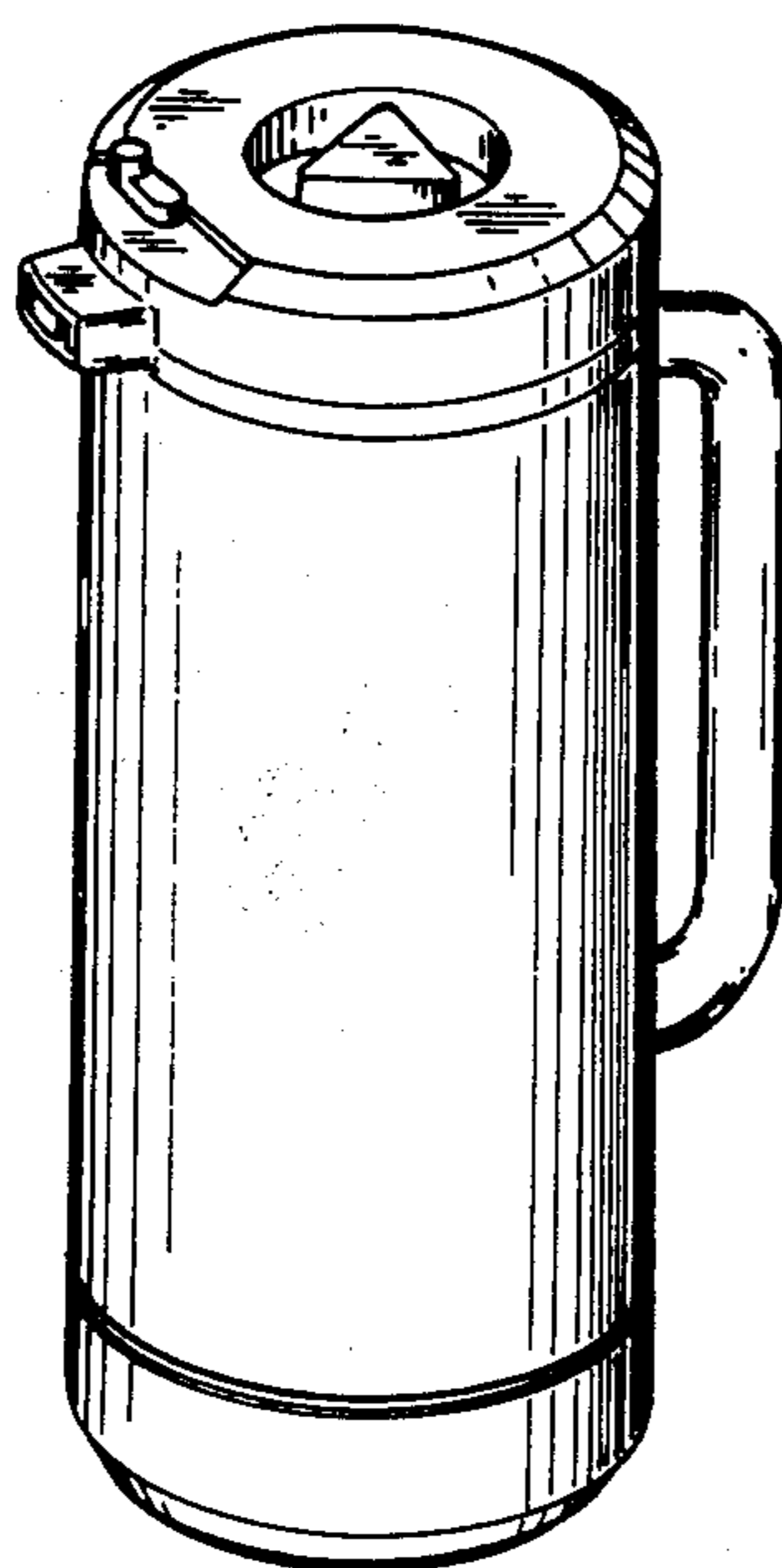

FIG. 2

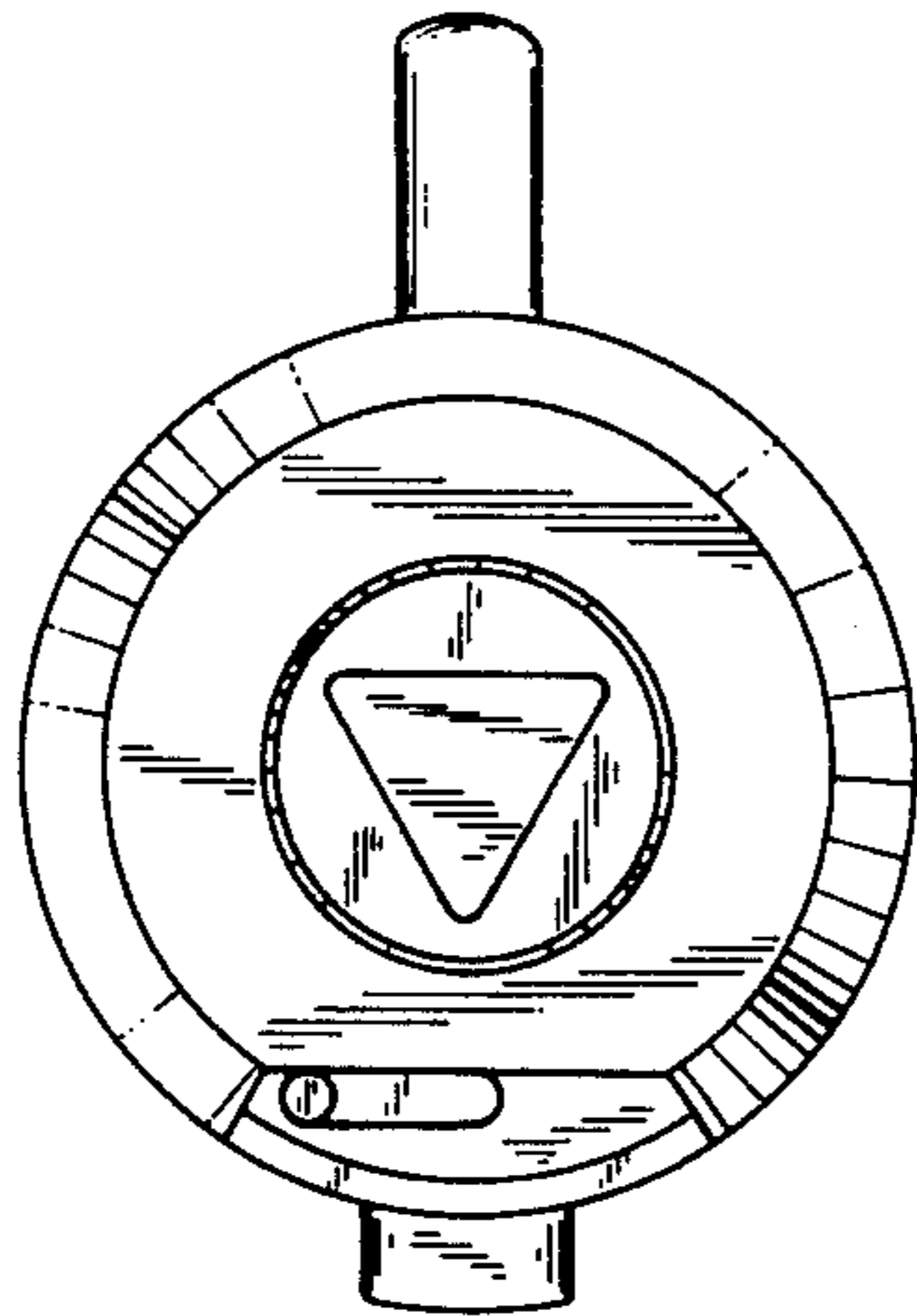

FIG. 3

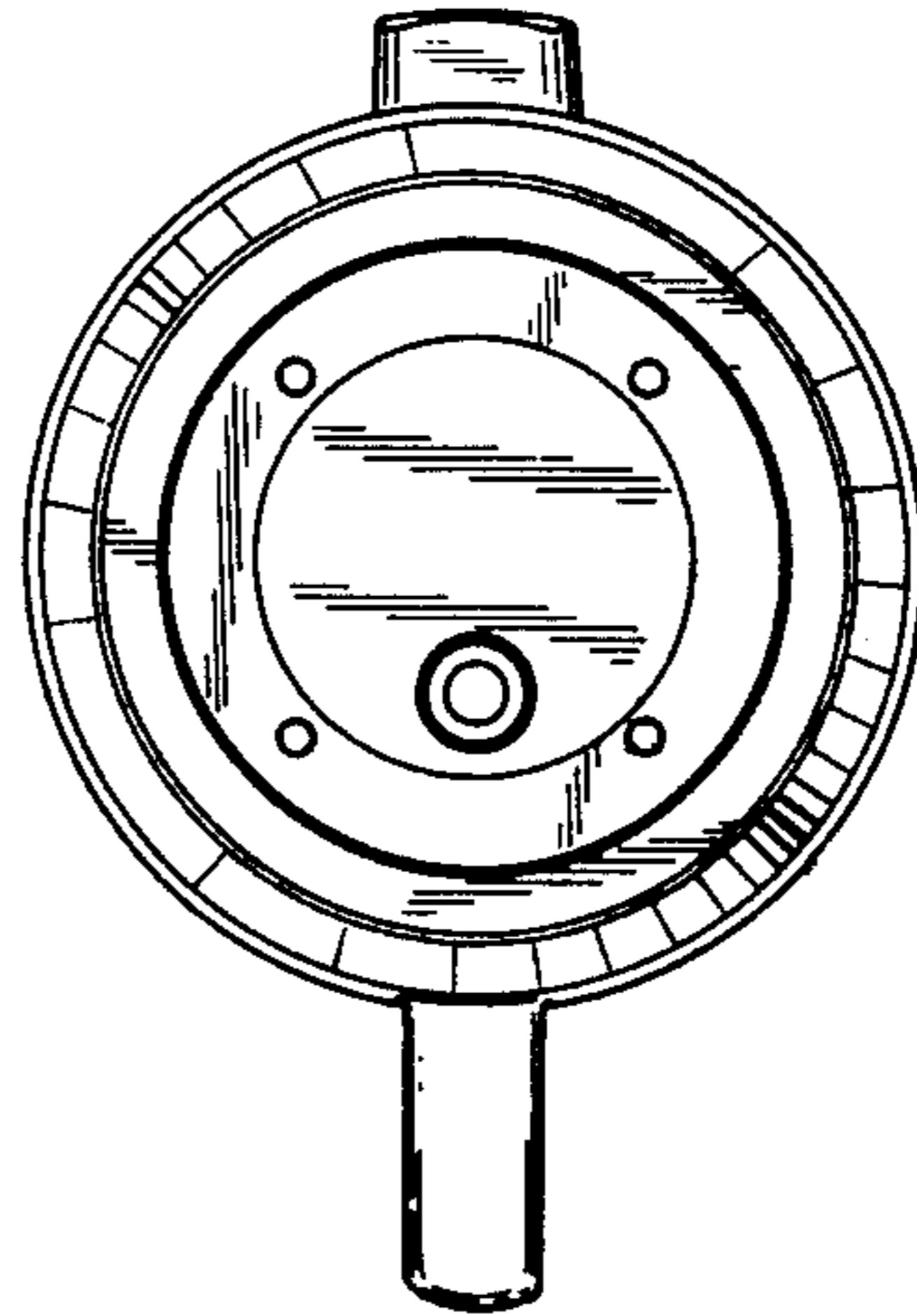

FIG. 4

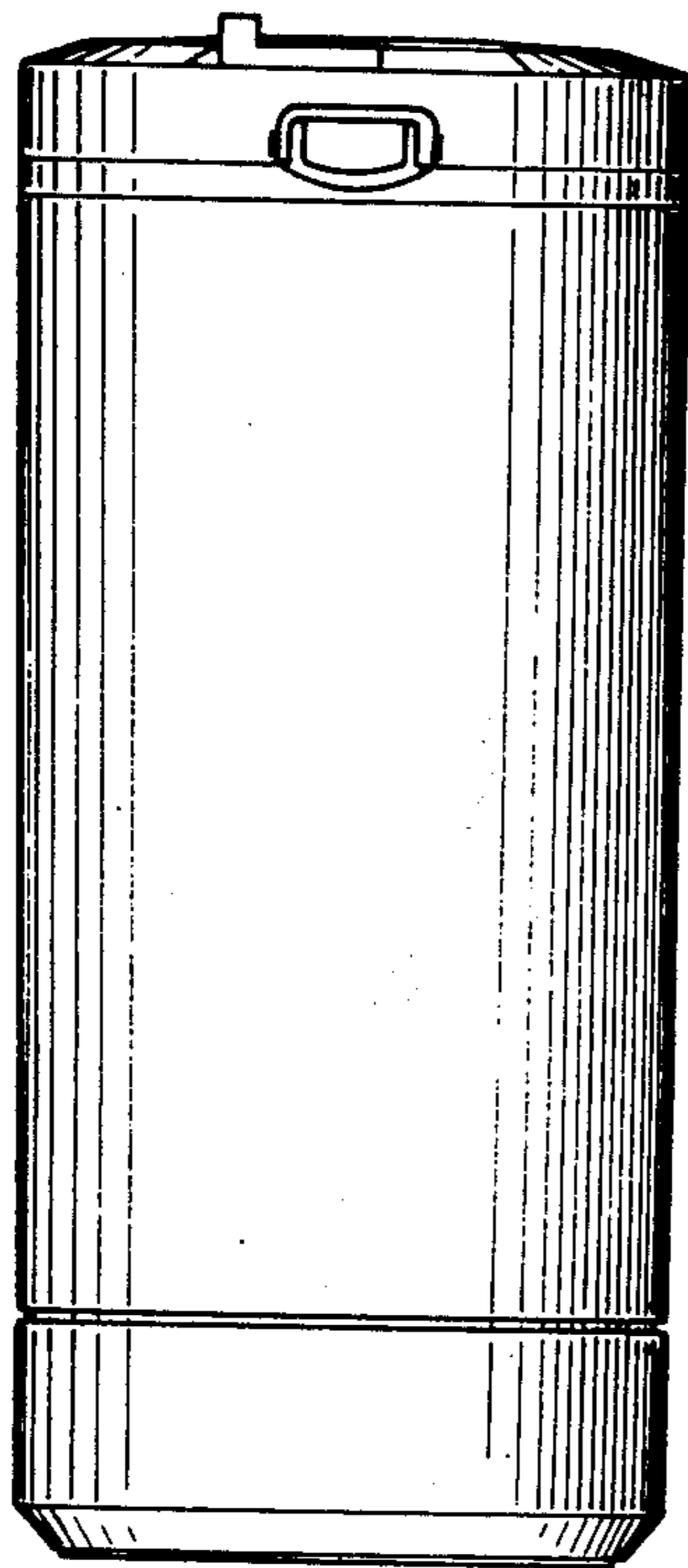

FIG. 5

