

- [54] SEAT
- [75] Inventor: **Harold Glaser**, St. Louis County, Mo.
- [73] Assignee: **James David Incorporated**, Maryland Heights, Mo.
- [*] Notice: The portion of the term of this patent subsequent to Mar. 28, 1992, has been disclaimed.
- [**] Term: **3½ Years**
- [21] Appl. No.: **782,981**
- [22] Filed: **Mar. 30, 1977**
- [51] Int. Cl. **D6—01**
- [52] U.S. Cl. **D6/73; D6/63; D6/71**
- [58] Field of Search **D6/67-78**

- D. 236,047 7/1975 Hoshall et al. D6/60
- D. 239,236 3/1976 Costabile D6/61
- D. 244,109 4/1977 Zola D6/73

OTHER PUBLICATIONS

"Office Products", 5-1976, p. 10, Sofa by Mill Craft. Modern Plastics, 6-1970, p. 73, Lower Chair by Landes.

Primary Examiner—Bruce W. Dunkins
Attorney, Agent, or Firm—Ralph W. Kalish

[57] CLAIM

The ornamental design for a seat, as shown.

DESCRIPTION

FIG. 1 is a perspective view of a seat, in the form of a chair, showing my new design.
 FIG. 2 is a side elevational view thereof.
 FIG. 3 is a top plan view thereof.
 FIG. 4 is a front elevational view thereof.
 FIG. 5 is a bottom plan view thereof.
 FIG. 6 is a rear elevational view thereof.
 FIG. 7 is a perspective view of a seat, in the form of a love seat, showing my new design.
 FIG. 8 is a perspective view of a seat, in the form of a sofa, showing my new design.

- [56] **References Cited**
- U.S. PATENT DOCUMENTS**
- D. 225,147 11/1972 Fisher D6/71
- D. 229,135 11/1973 Ruoslahti D6/69 X
- D. 234,171 1/1975 Long D6/71

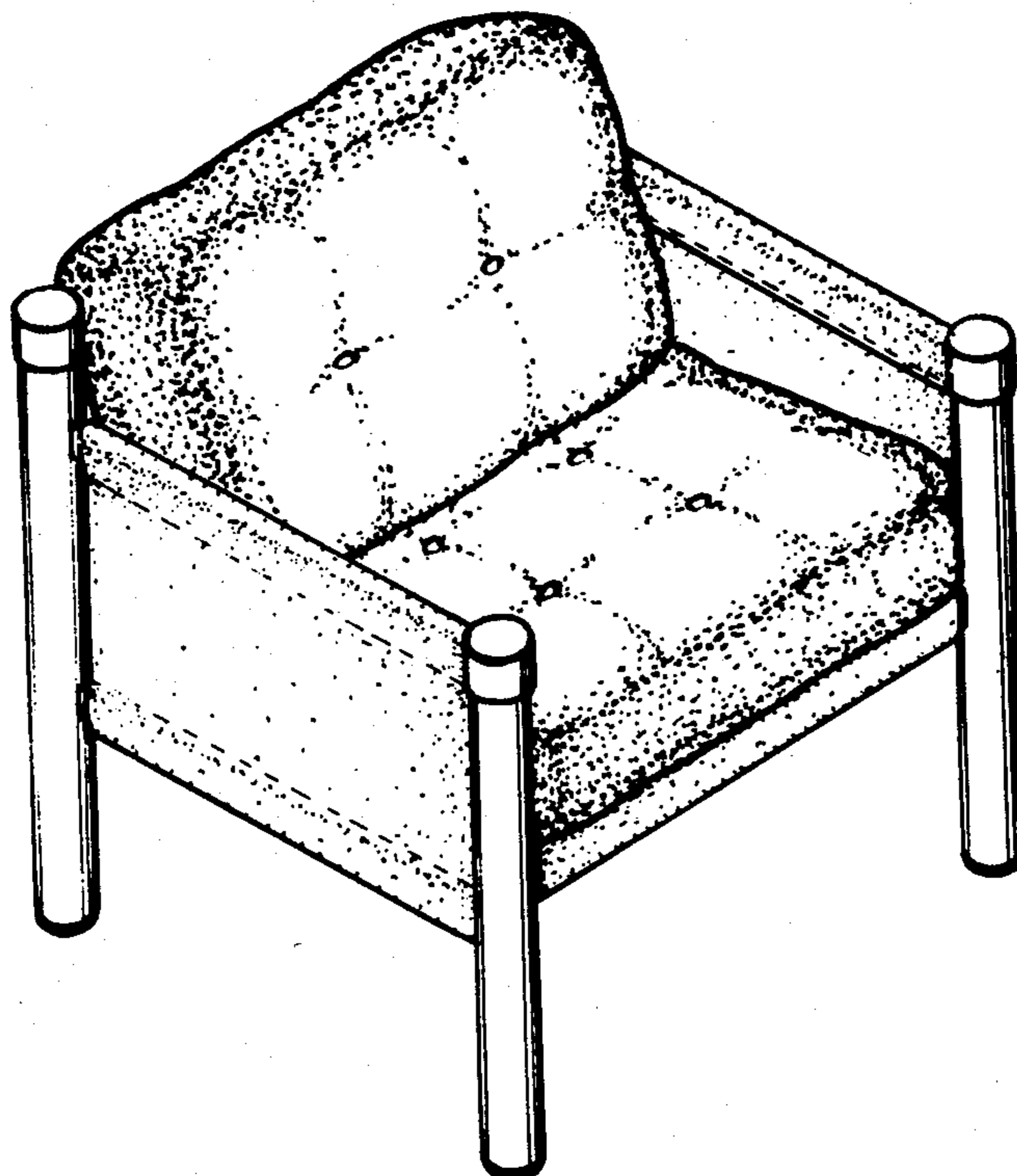

FIG. 1

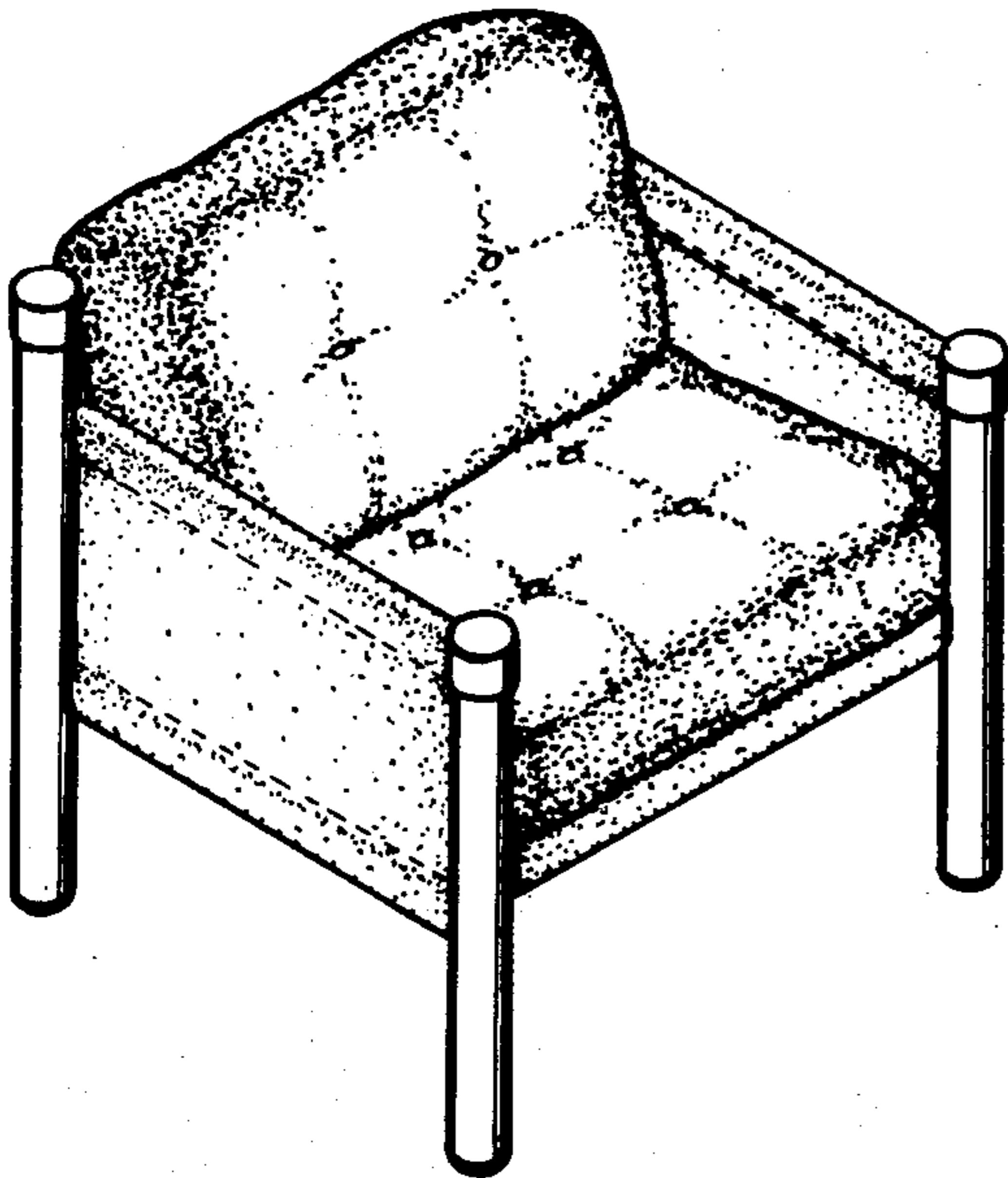

FIG. 2

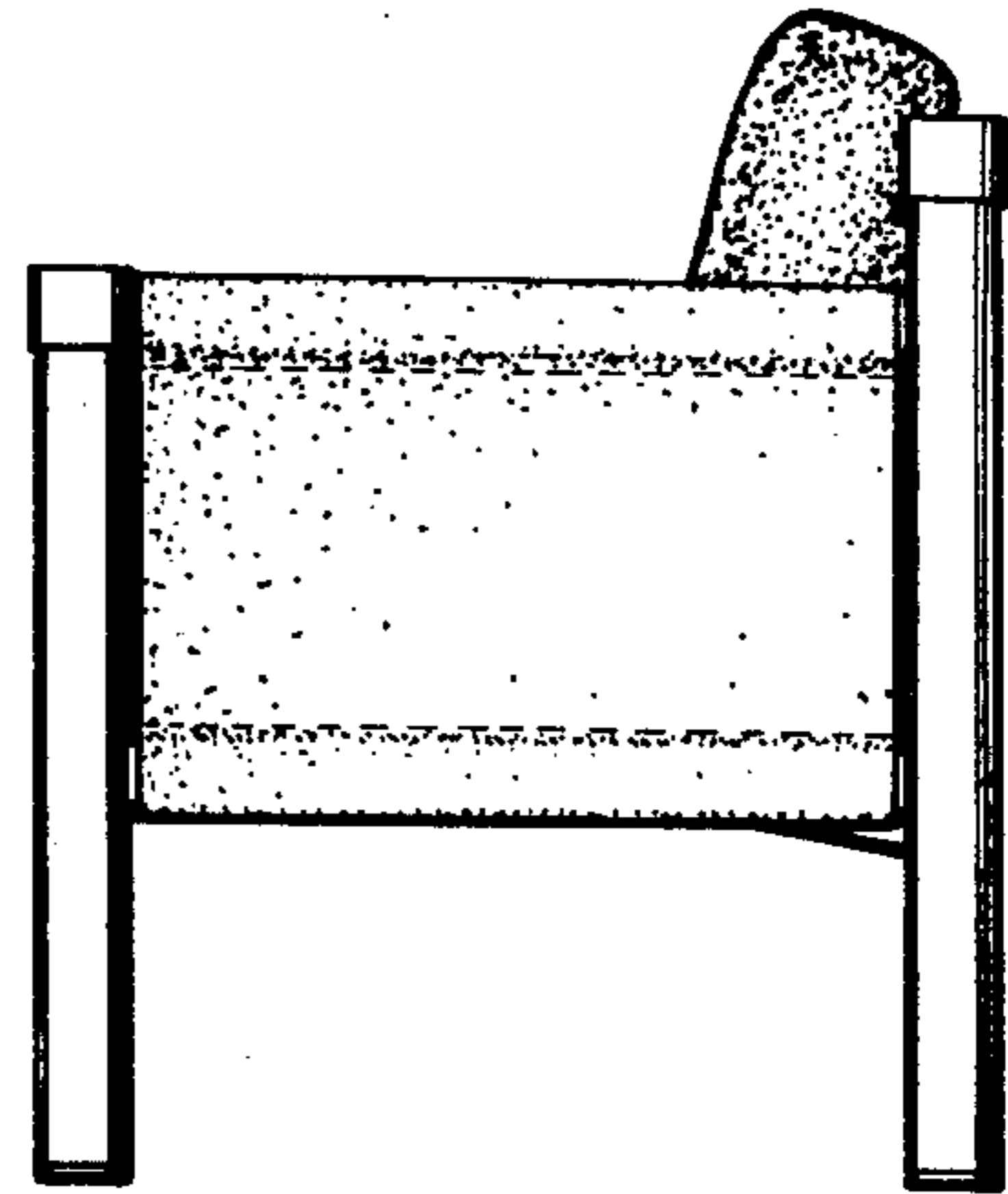

FIG. 3

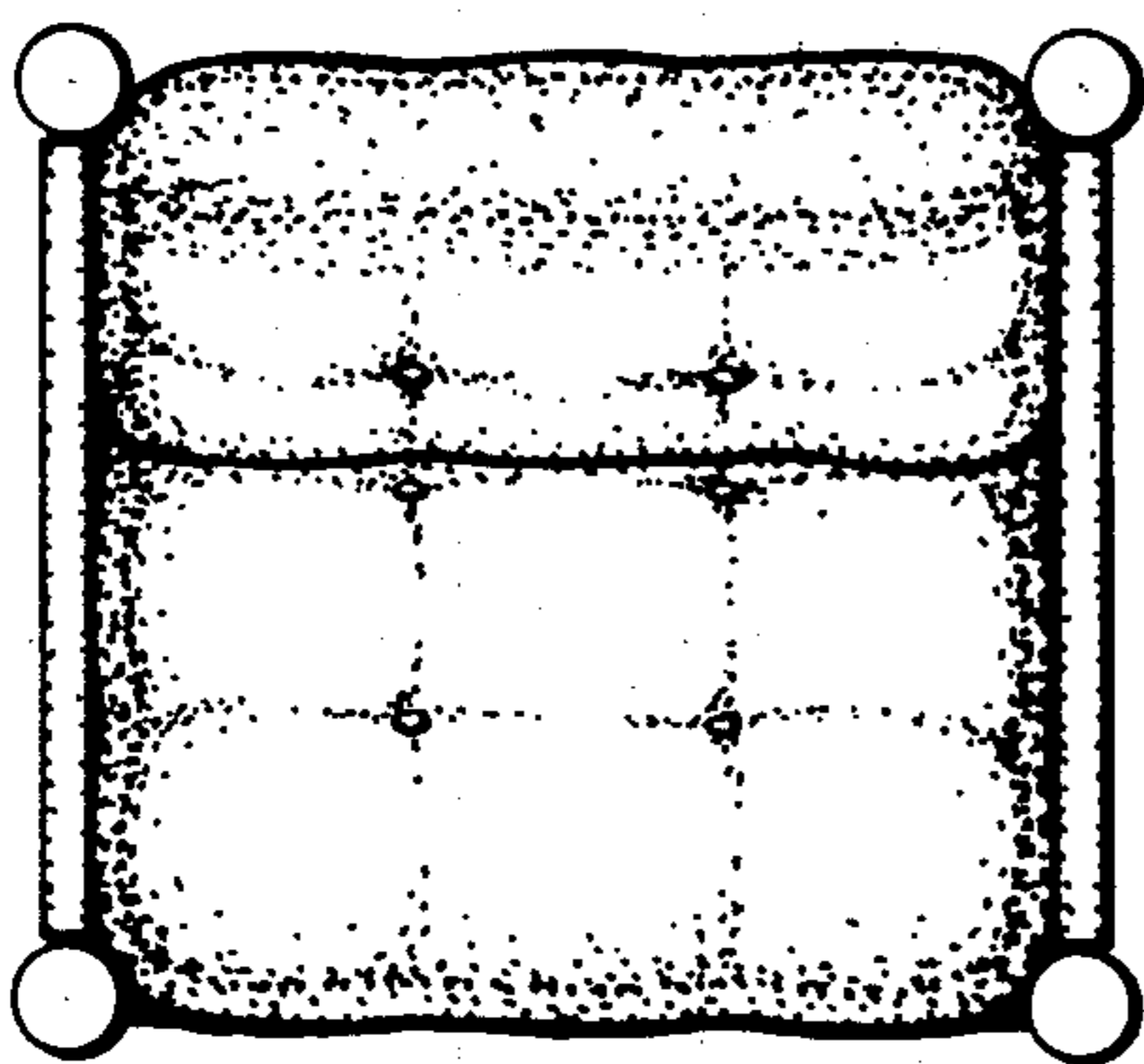

FIG. 4

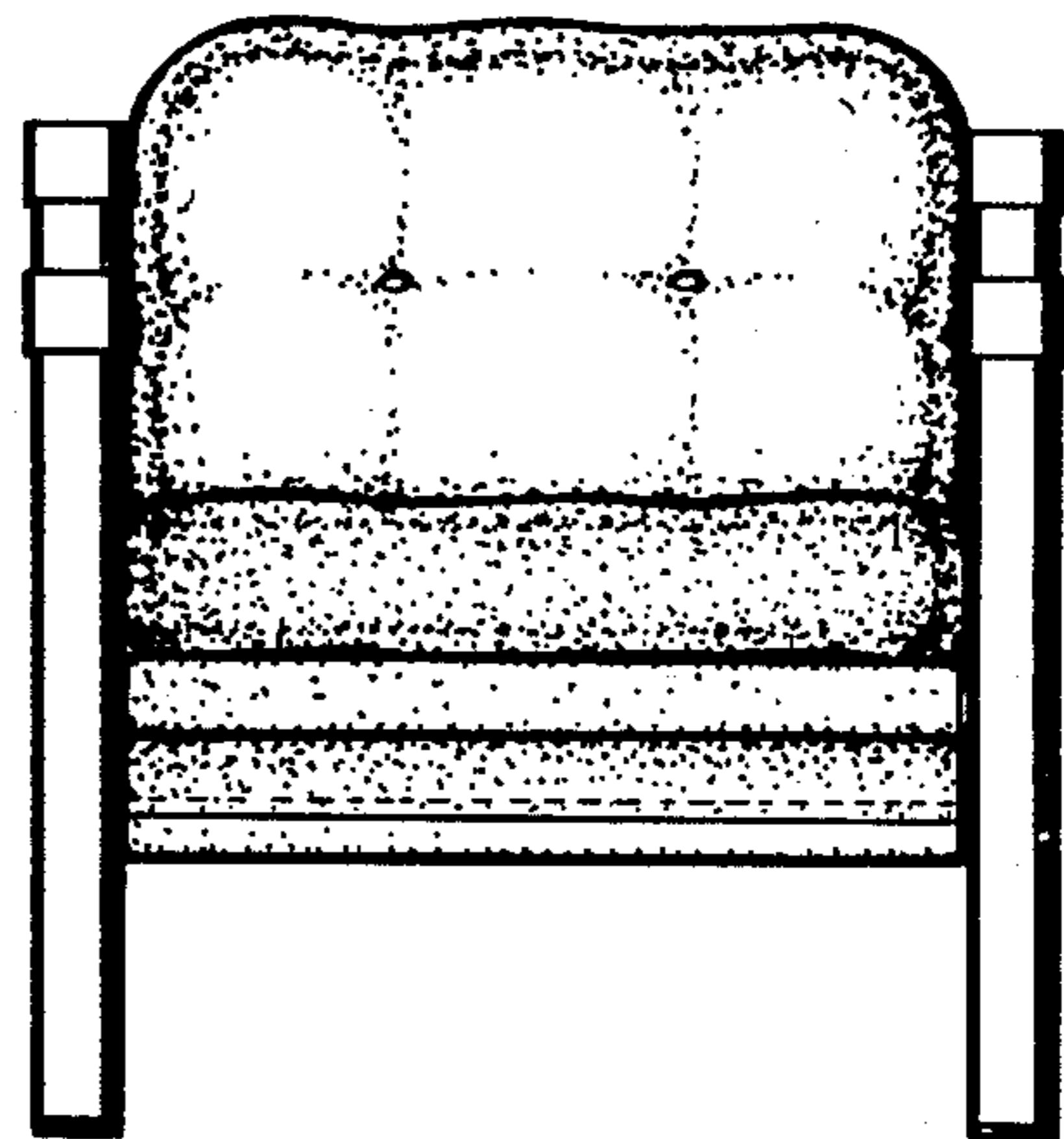

FIG. 5

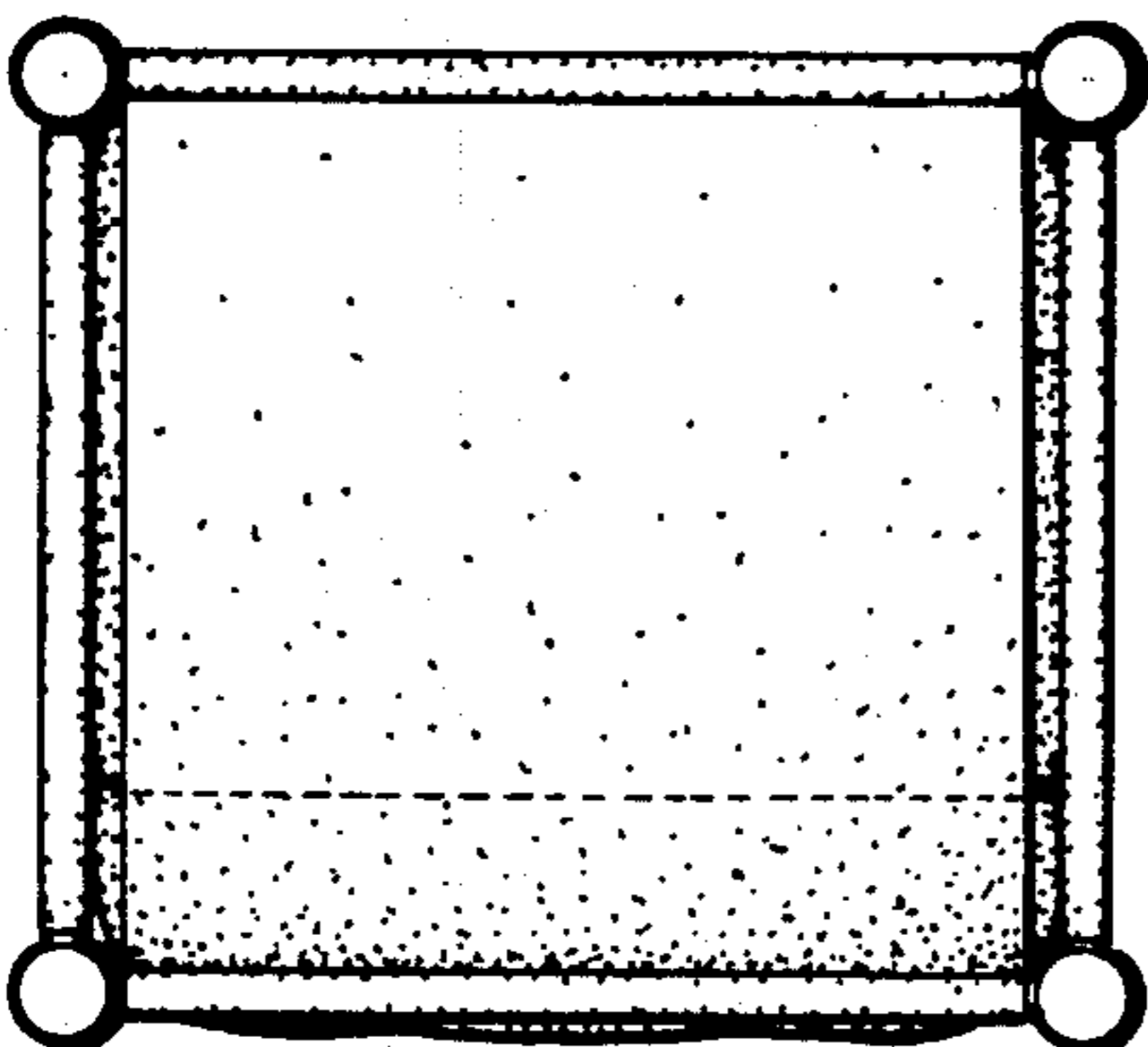
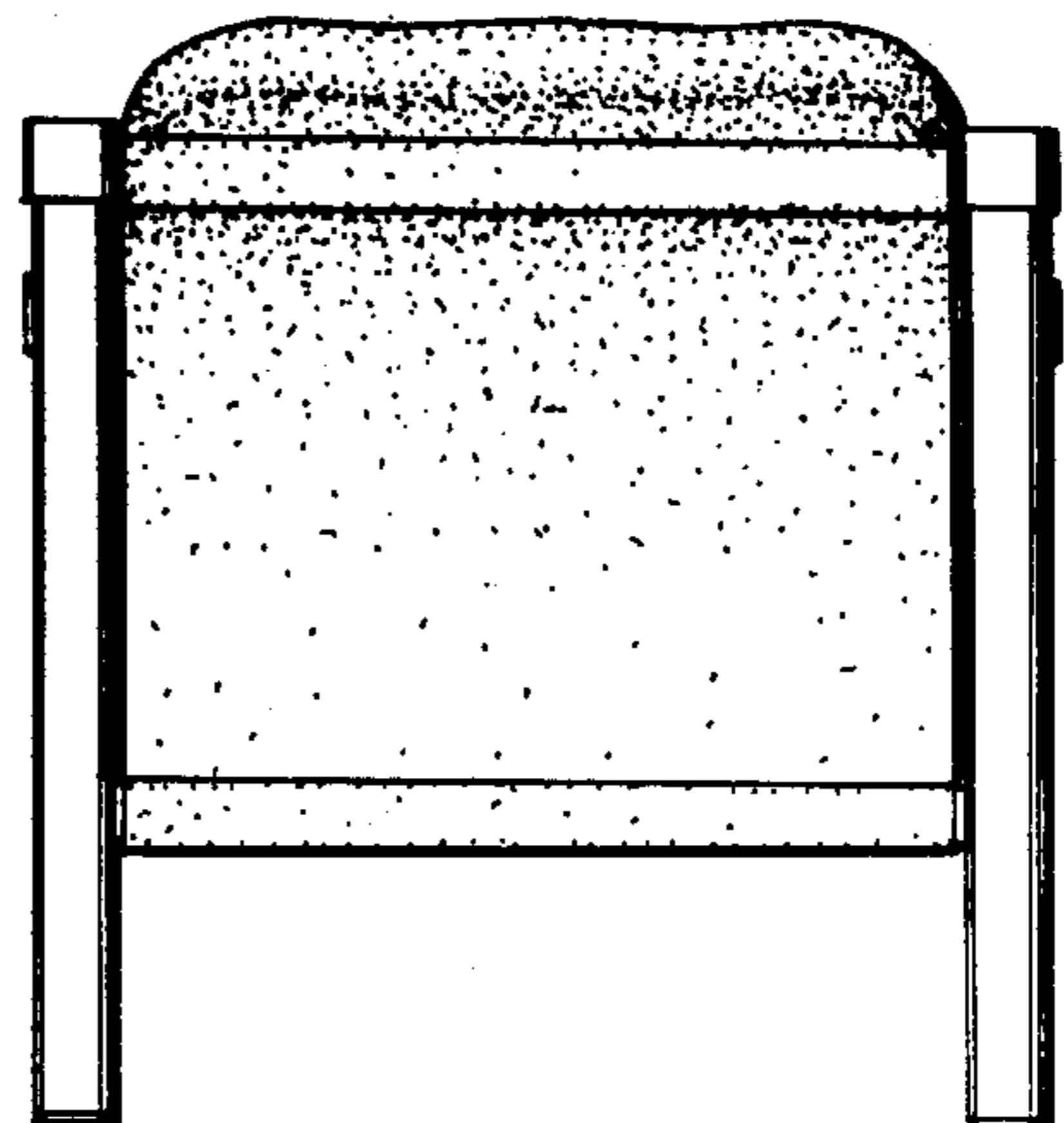

FIG. 6



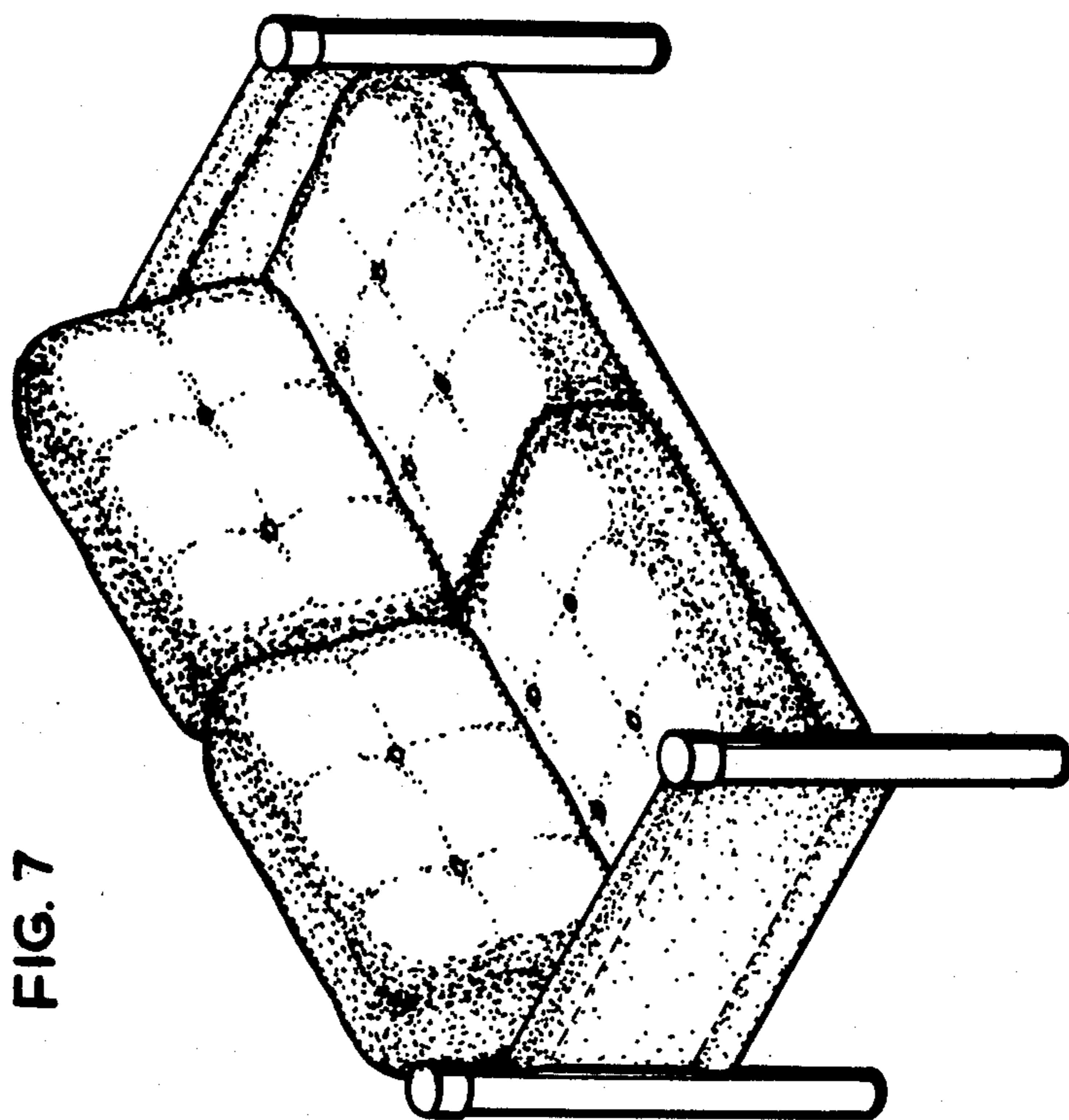

FIG. 7

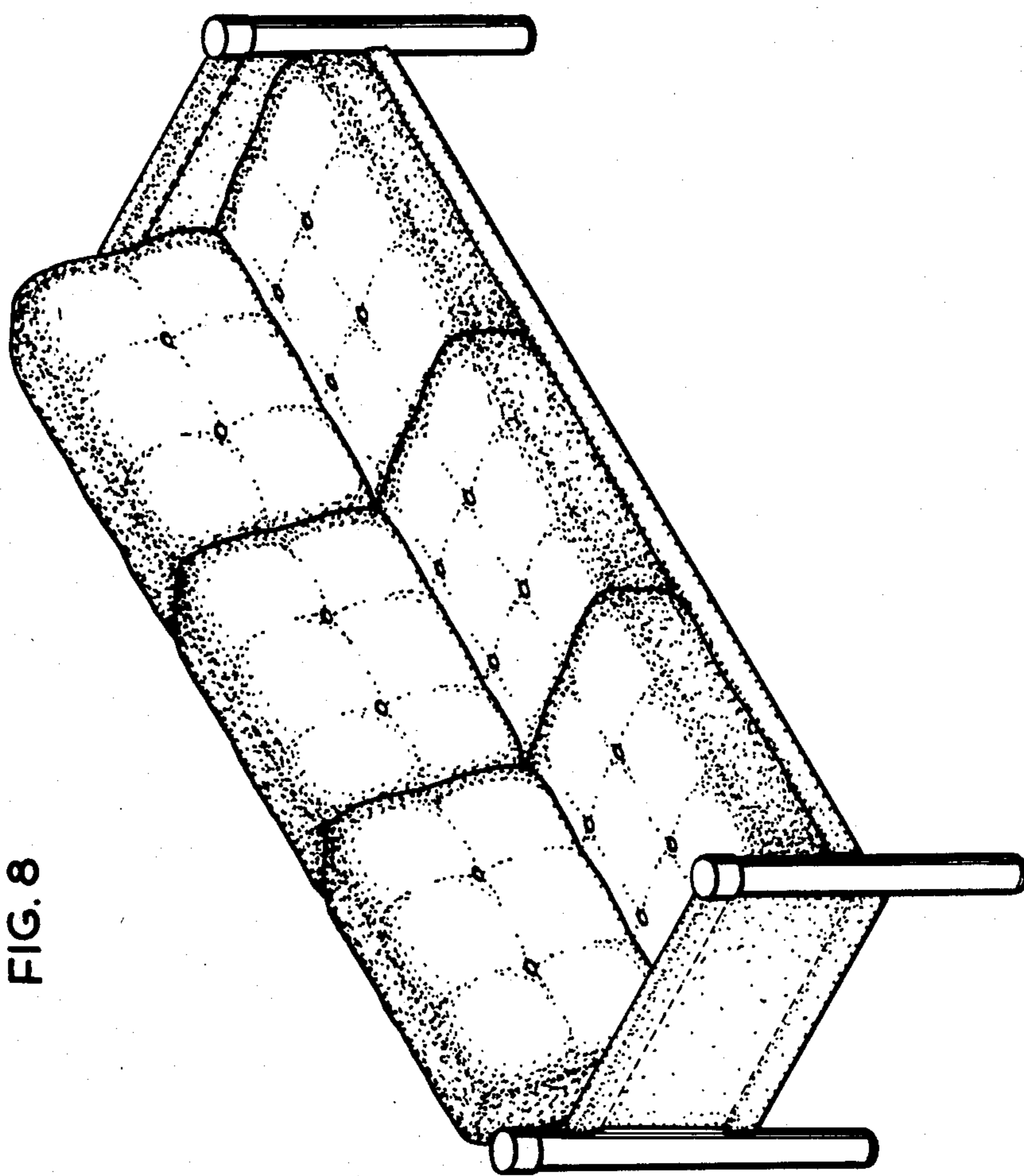

FIG. 8