

[54] **PHOTOCHEMOTHERAPY BED PATIENT UNIT**
 [75] Inventors: **Ronald G. Blaisdell, Saugus; Harold L. Hough, Beverly; Robert E. Levin, Hamilton, all of Mass.**

2,183,335	12/1939	McKendrick	128/371
2,289,881	7/1942	Mallory et al.	128/373
2,530,442	11/1950	Rouat	128/373
2,676,596	4/1954	Rouat	128/373
3,361,895	1/1968	Achner	128/374 X
3,576,997	5/1971	Slavin	128/439 R
3,648,706	3/1972	Holzer	128/395
3,986,513	10/1976	Stuhl	128/373

[73] Assignee: **Ing. C. Olivetti & C., S.p.A., Ivrea, Italy**

*Primary Examiner—Bernard Ansher
 Attorney, Agent, or Firm—Norman J. O'Malley*

[**] Term: **14 Years**
 [21] Appl. No.: **660,946**
 [22] Filed: **Feb. 24, 1976**

[57] **CLAIM**
 The ornamental design for a photochemotherapy bed patient unit, as shown.

[51] Int. Cl. **D24—01**
 [52] U.S. Cl. **D24/39; D24/38**
 [58] Field of Search **D24/1.1, 3, 36, 37, D24/38; 128/373, 395; 250/439**

DESCRIPTION

FIG. 1 is a perspective view of the photochemotherapy unit showing our new design;
 FIG. 2 is a top plan view of the unit;
 FIG. 3 is an elevation view of one end of the unit;
 FIG. 4 is an elevation view of the other end of the unit;
 FIG. 5 is a bottom plan view of the unit;
 FIG. 6 is an elevation view of one side of the unit; and
 FIG. 7 is an elevation view of the other side of the unit.

- [56] **References Cited**
U.S. PATENT DOCUMENTS
 D. 52,426 9/1918 Blanchard D24/38
 D. 109,880 5/1938 Simon D24/3
 D. 226,991 5/1973 Tegner D24/1.1 X

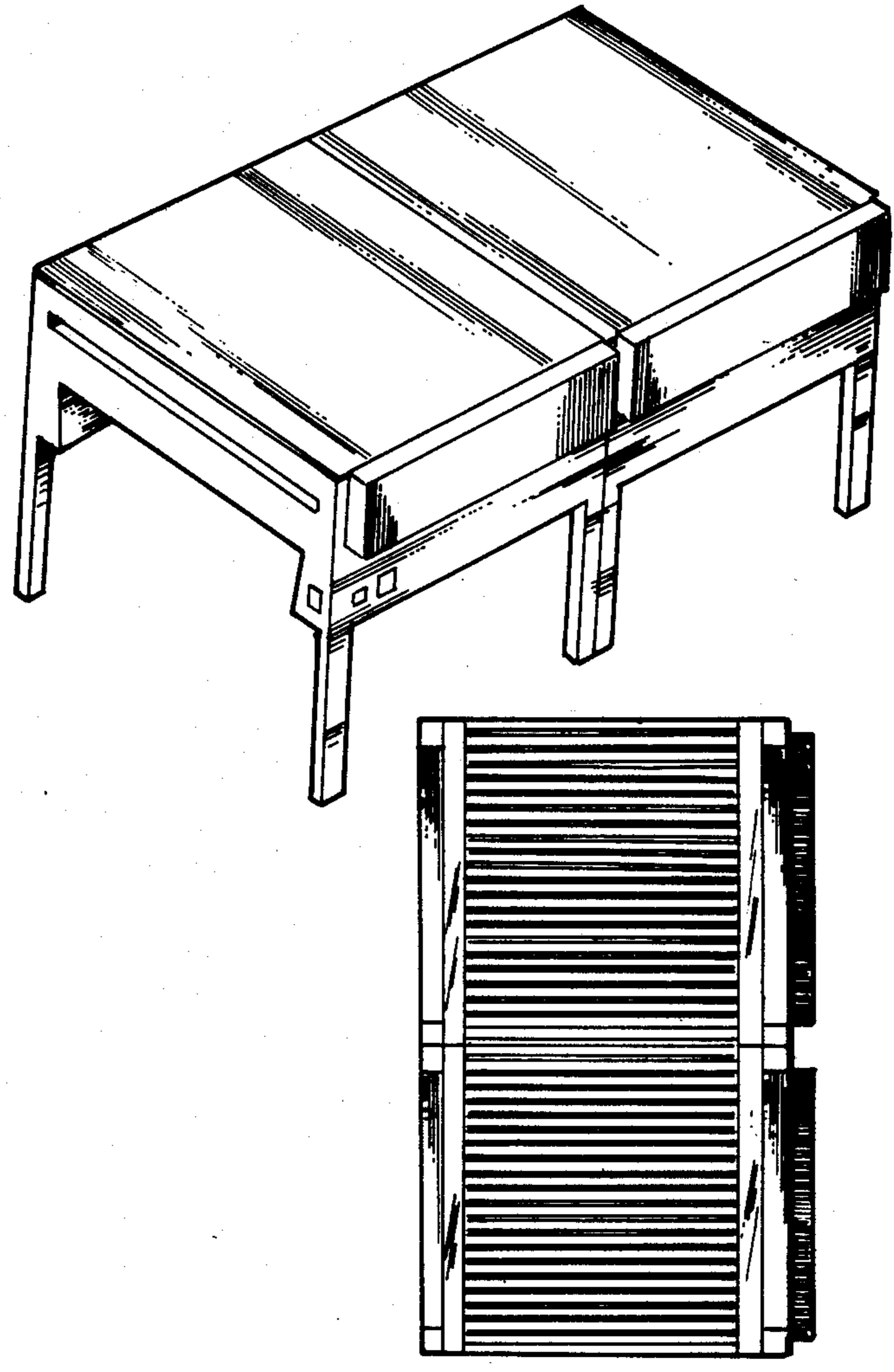

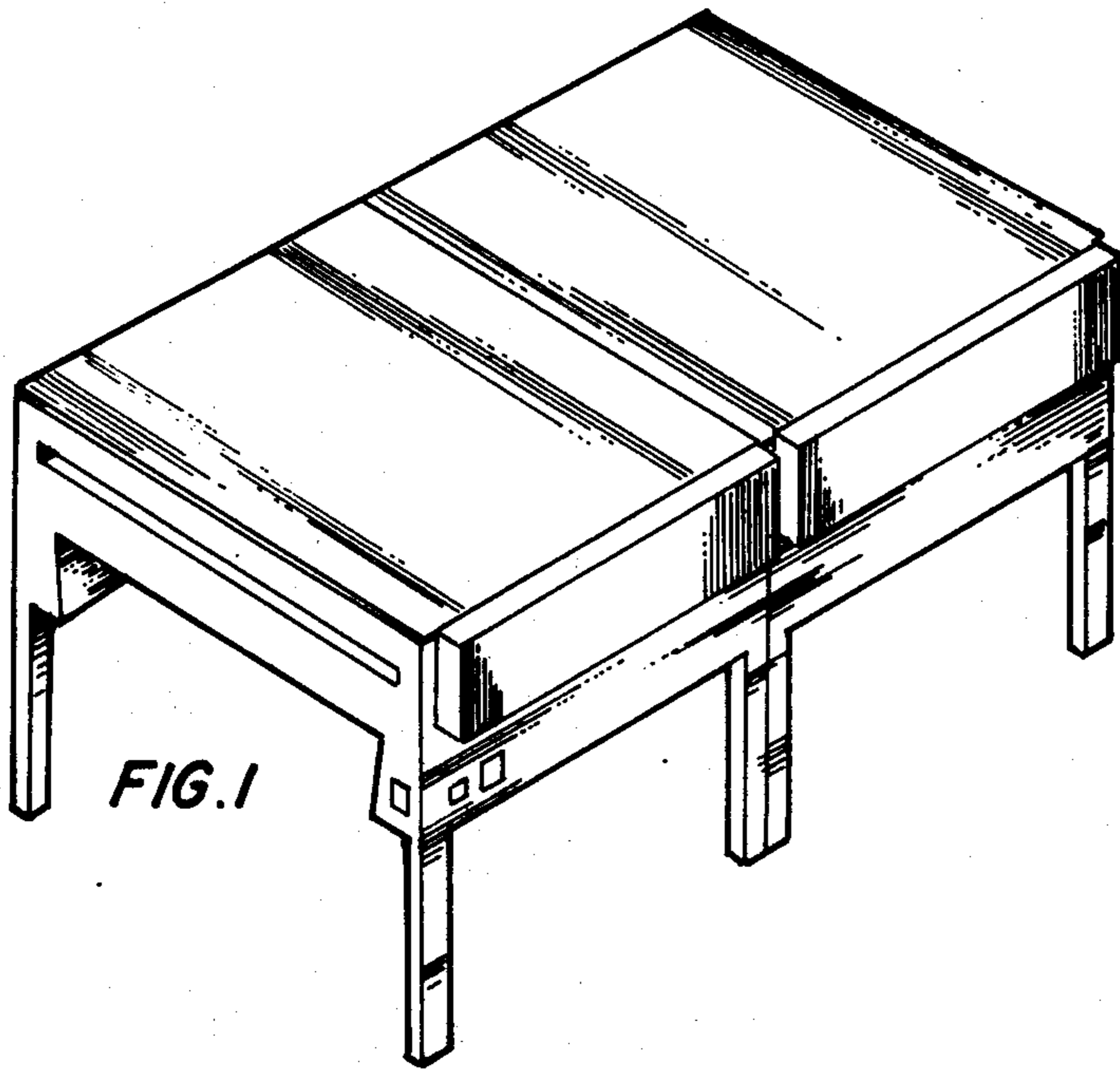

FIG. 1

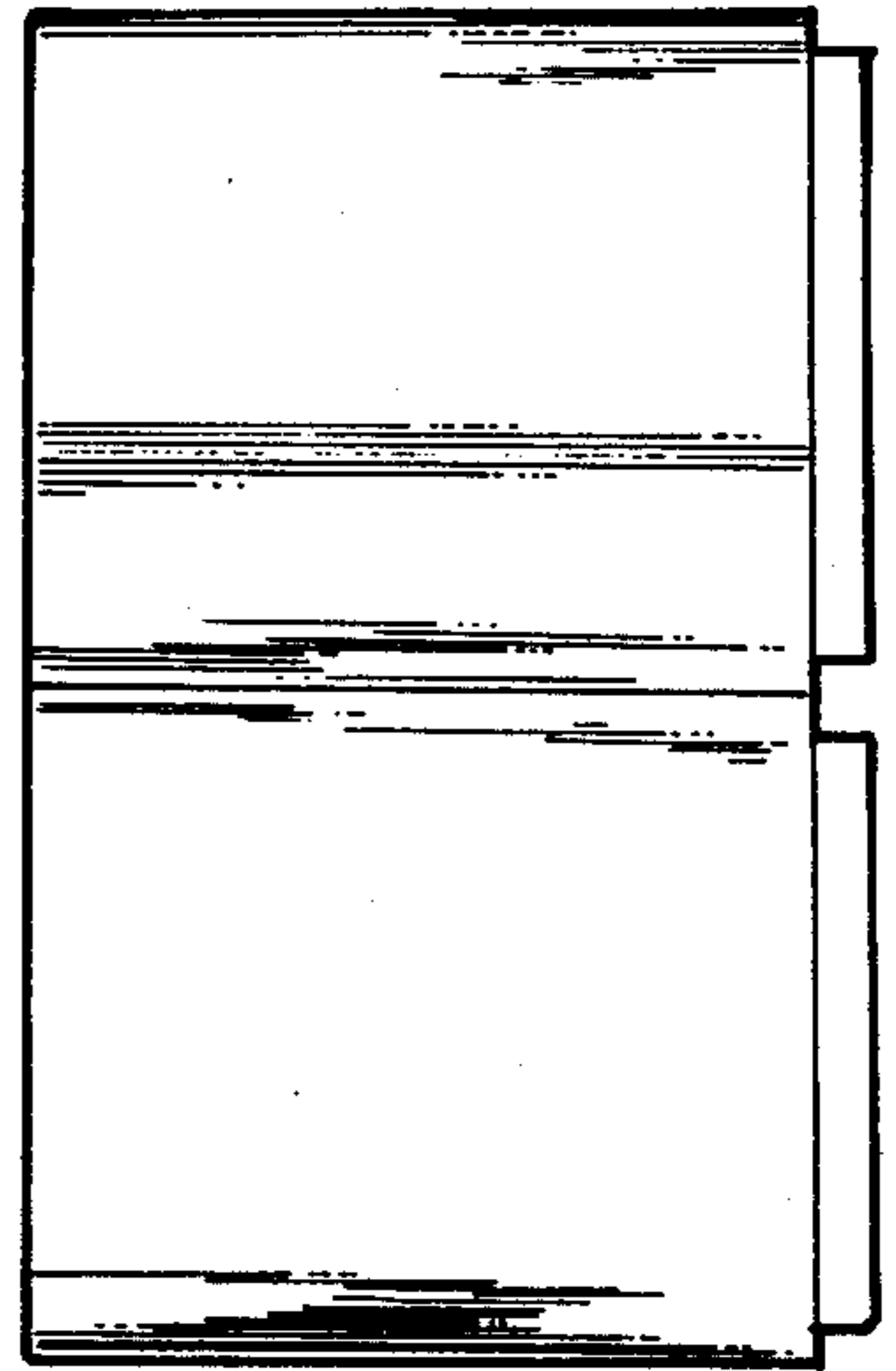

FIG. 2

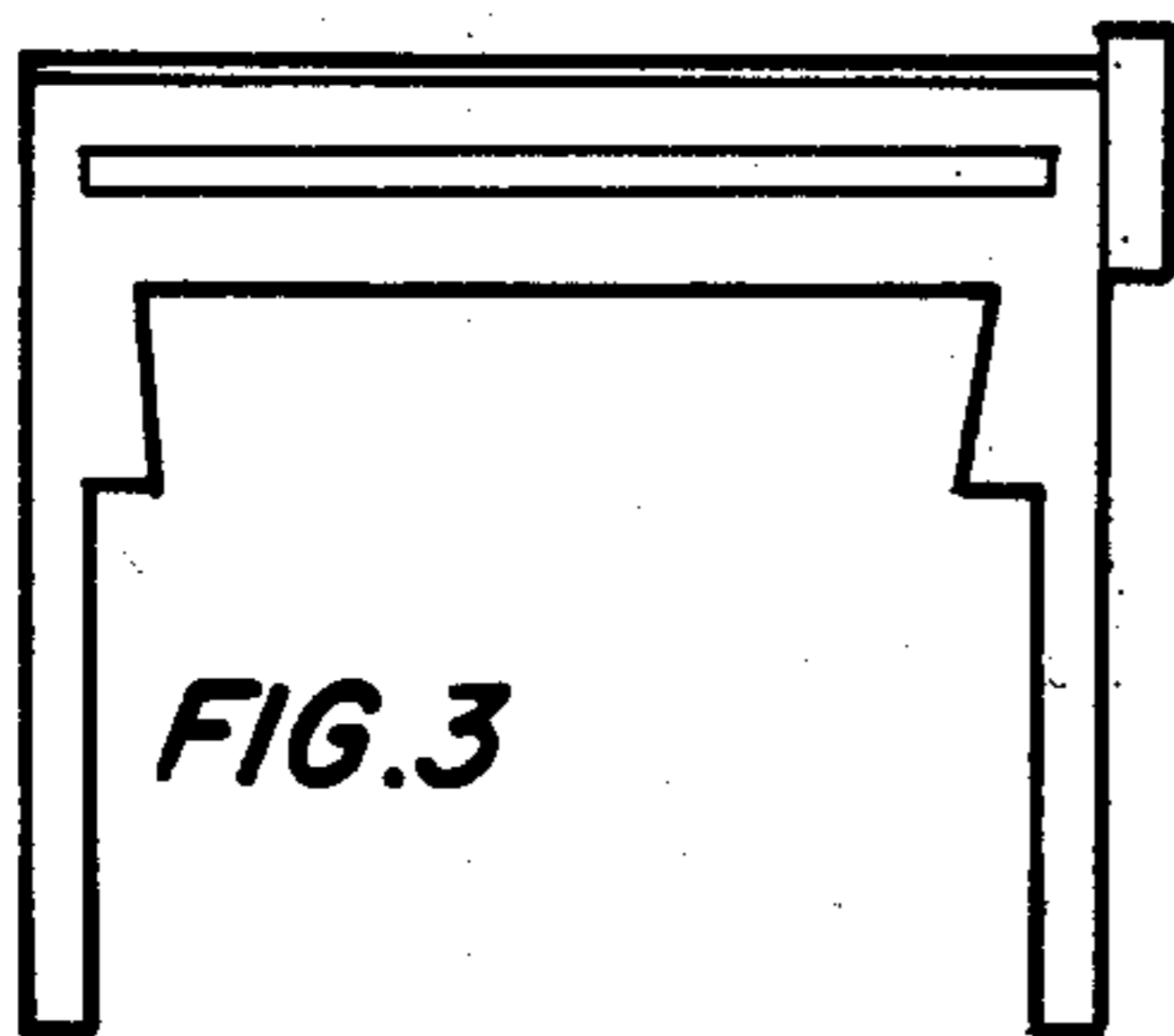

FIG. 3

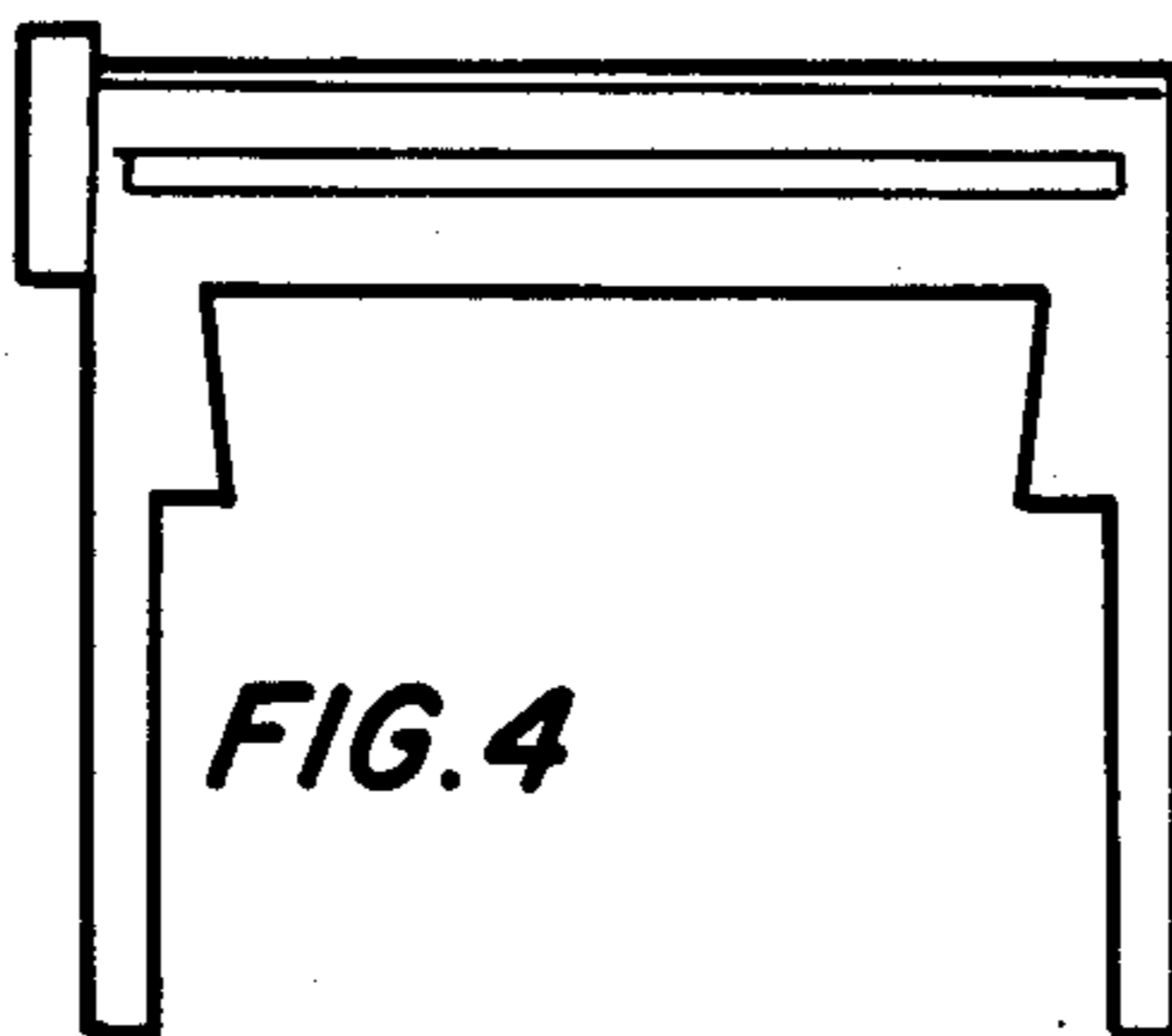

FIG. 4

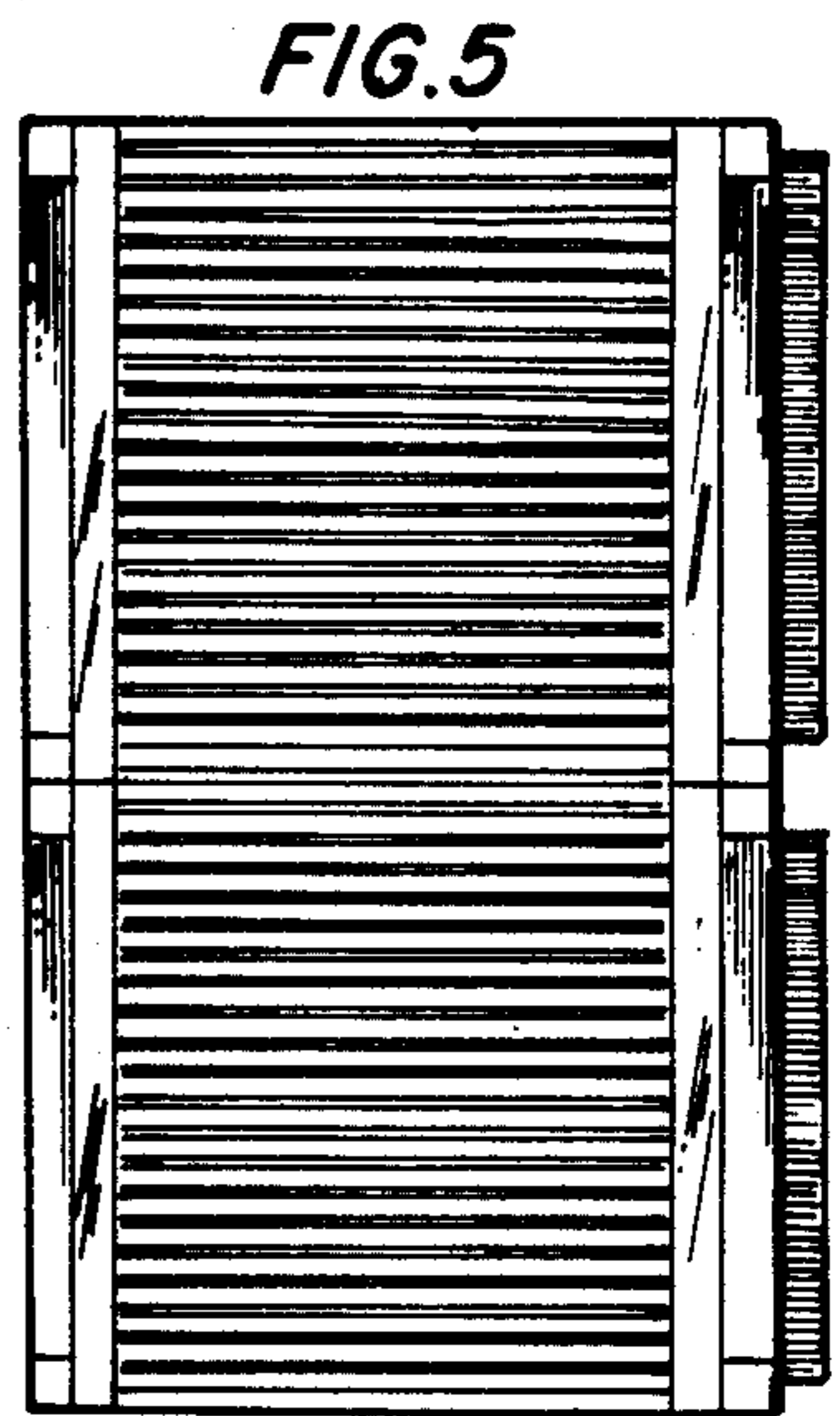

FIG. 5

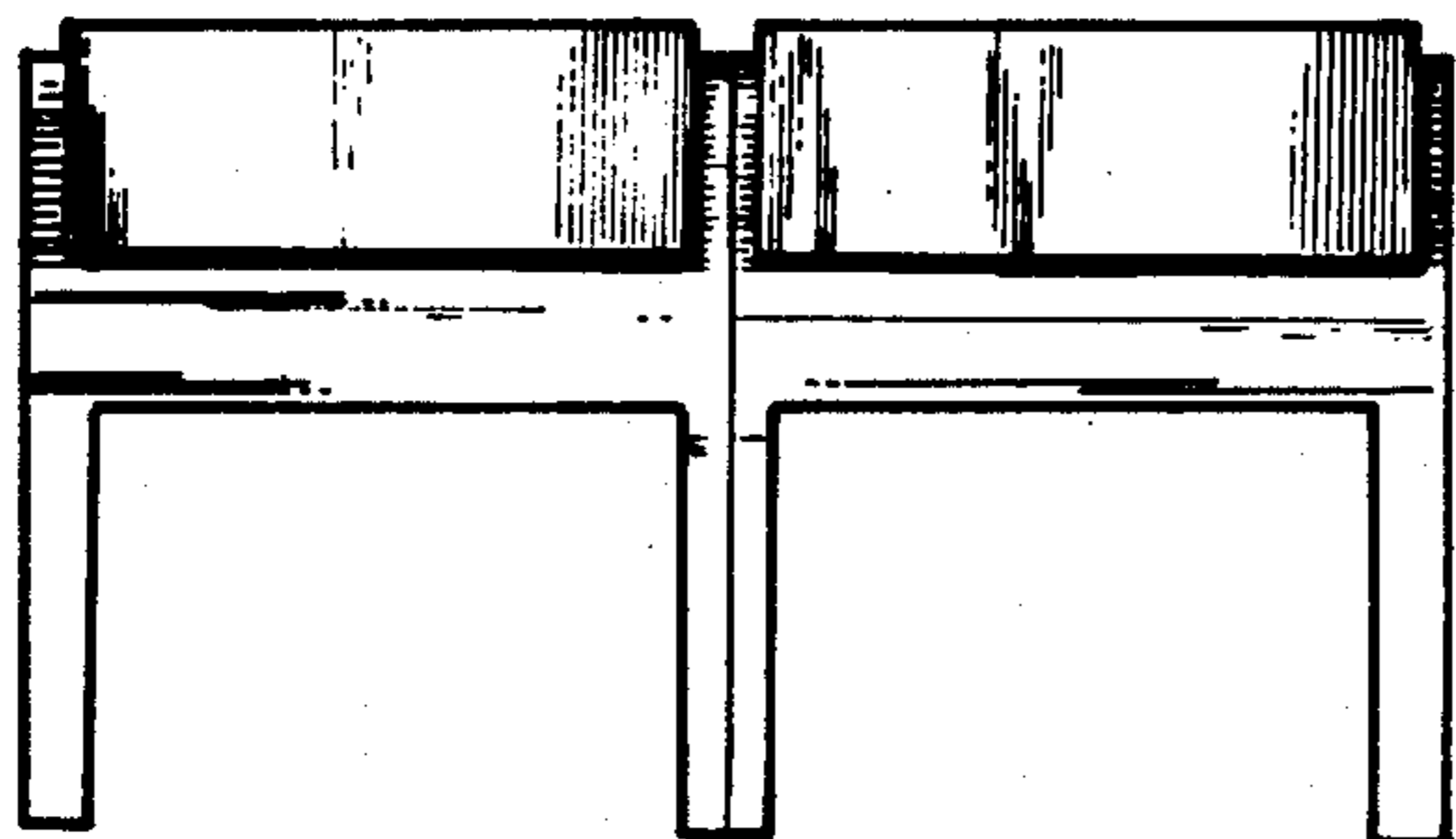

FIG. 6

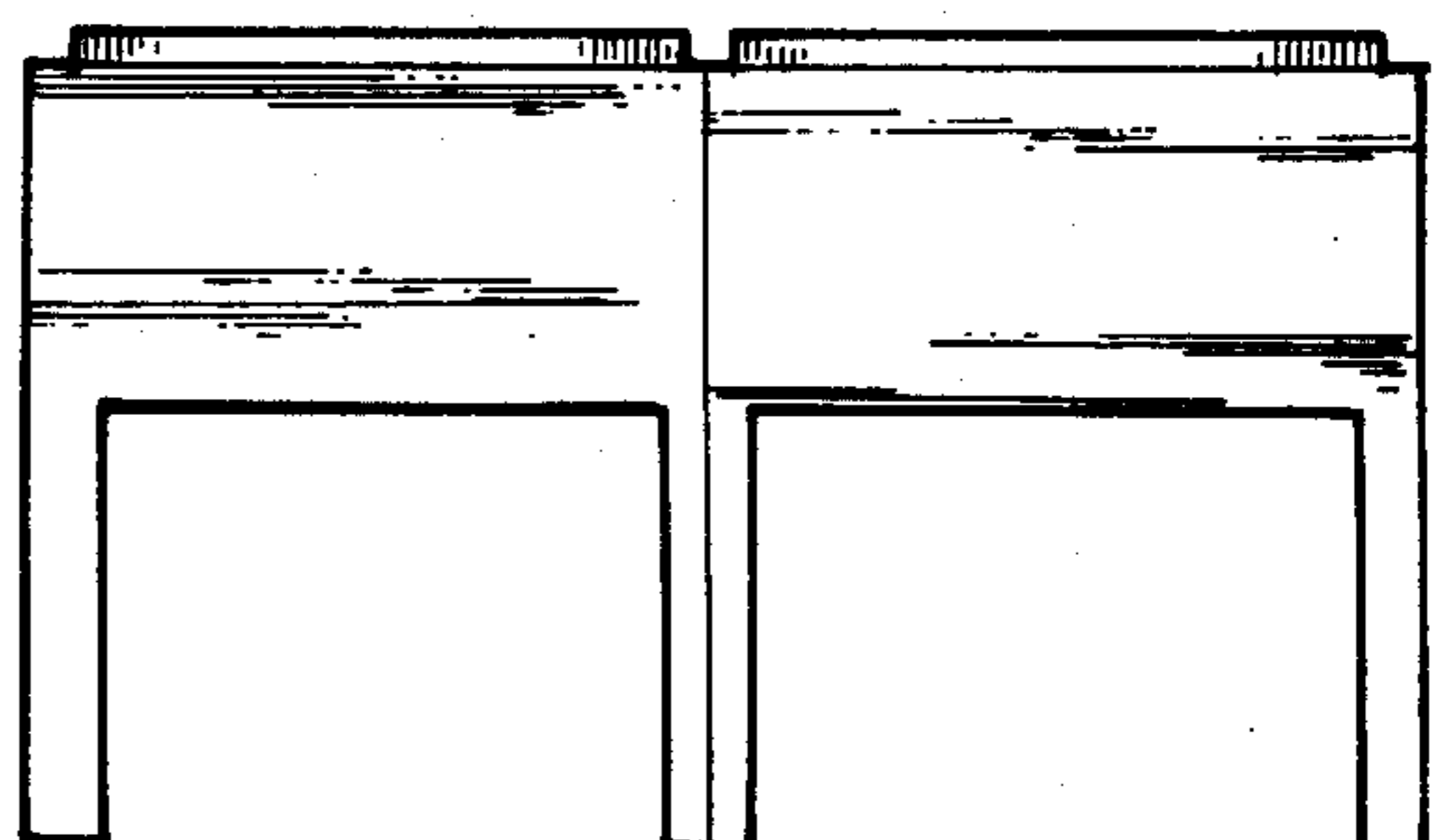

FIG. 7

UNITED STATES PATENT AND TRADEMARK OFFICE
CERTIFICATE OF CORRECTION

PATENT NO. : Des. 251,611
DATED : April 17, 1979
INVENTOR(S) : Ronald G. Blaisdell et al.

It is certified that error appears in the above—identified patent and that said Letters Patent is hereby corrected as shown below:

On The Title Page Item 73, should read

-- Assignee: GTE Sylvania Incorporated,
Stamford, Conn. --.

Signed and Sealed this
Twenty-ninth Day of April 1980

[SEAL]

Attest:

Attesting Officer

SIDNEY A. DIAMOND

Commissioner of Patents and Trademarks