

[54] **BENCH OR SIMILAR ARTICLE**

[76] **Inventor:** Ramon R. Albert, 1451 Washington Ave., Bronx, New York, N.Y. 10456

[**] **Term:** 14 Years

[21] **Appl. No.:** 782,942

[22] **Filed:** Mar. 30, 1977

[51] **Int. Cl.** D6—01

[52] **U.S. Cl.** D6/59; D6/46; D6/58; D6/61; D6/75; D6/78

[58] **Field of Search** D6/42, 45, 47-78

[56] **References Cited**

U.S. PATENT DOCUMENTS

D. 166,463	4/1952	Goulart	D6/46
D. 192,913	5/1962	Wilson	D6/46
D. 193,321	7/1962	Thomas	D6/46 X
D. 215,598	10/1969	Miller	D6/59
D. 231,587	5/1974	Herrera	D6/45 X
D. 241,485	9/1976	Blodee	D6/59 X

Primary Examiner—Bruce W. Dunkins
Attorney, Agent, or Firm—Martin G. Raskin

[57] **CLAIM**

The ornamental design for a bench or similar article, as shown.

DESCRIPTION

FIG. 1 is a perspective view of a bench or similar article of the present invention;
FIG. 2 is a top view of a bench or similar article of the present invention;
FIG. 3 is a front elevation view of a bench or similar article of the present invention;
FIG. 4 is a side elevation view of a bench or similar article of the present invention;
FIG. 5 is a bottom view of a bench or similar article of the present invention;
FIG. 6 is a rear elevation view of a bench or similar article of the present invention; and
FIG. 7 is a perspective view of another embodiment of a bench or similar article of the present invention.

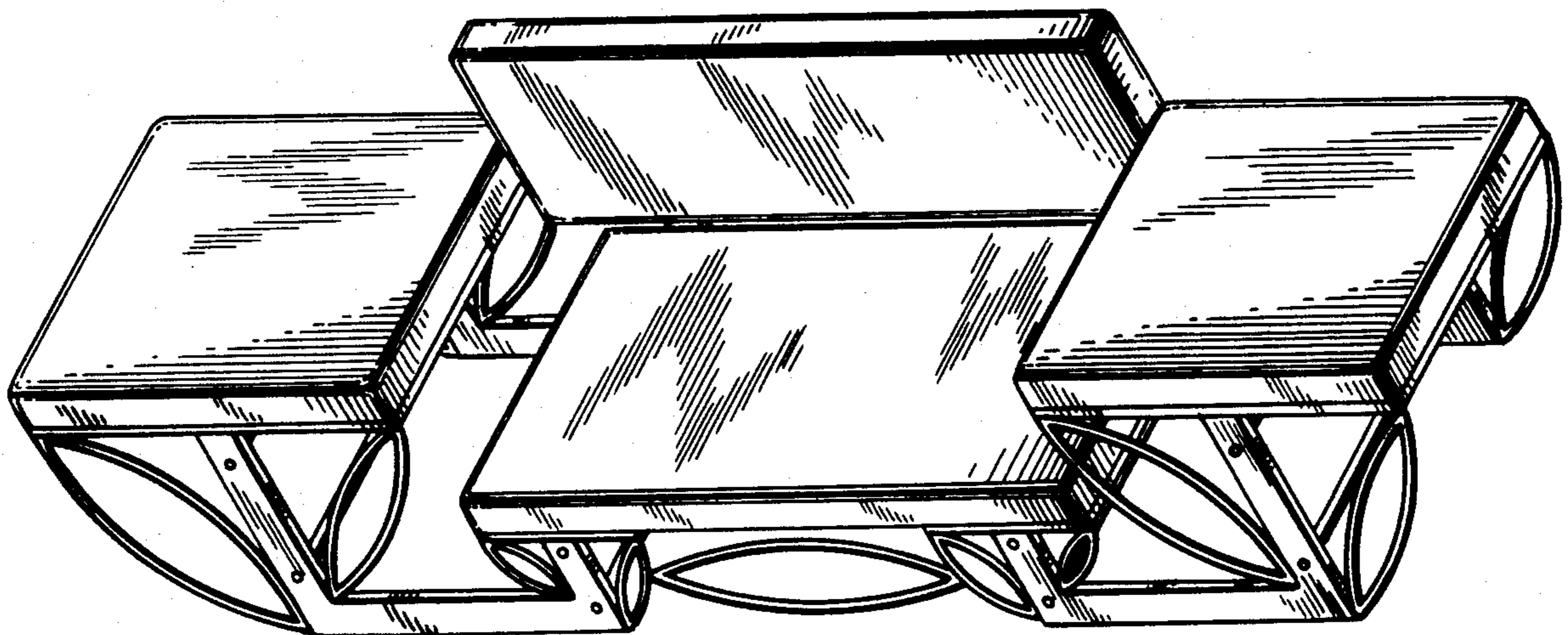

FIG. 1

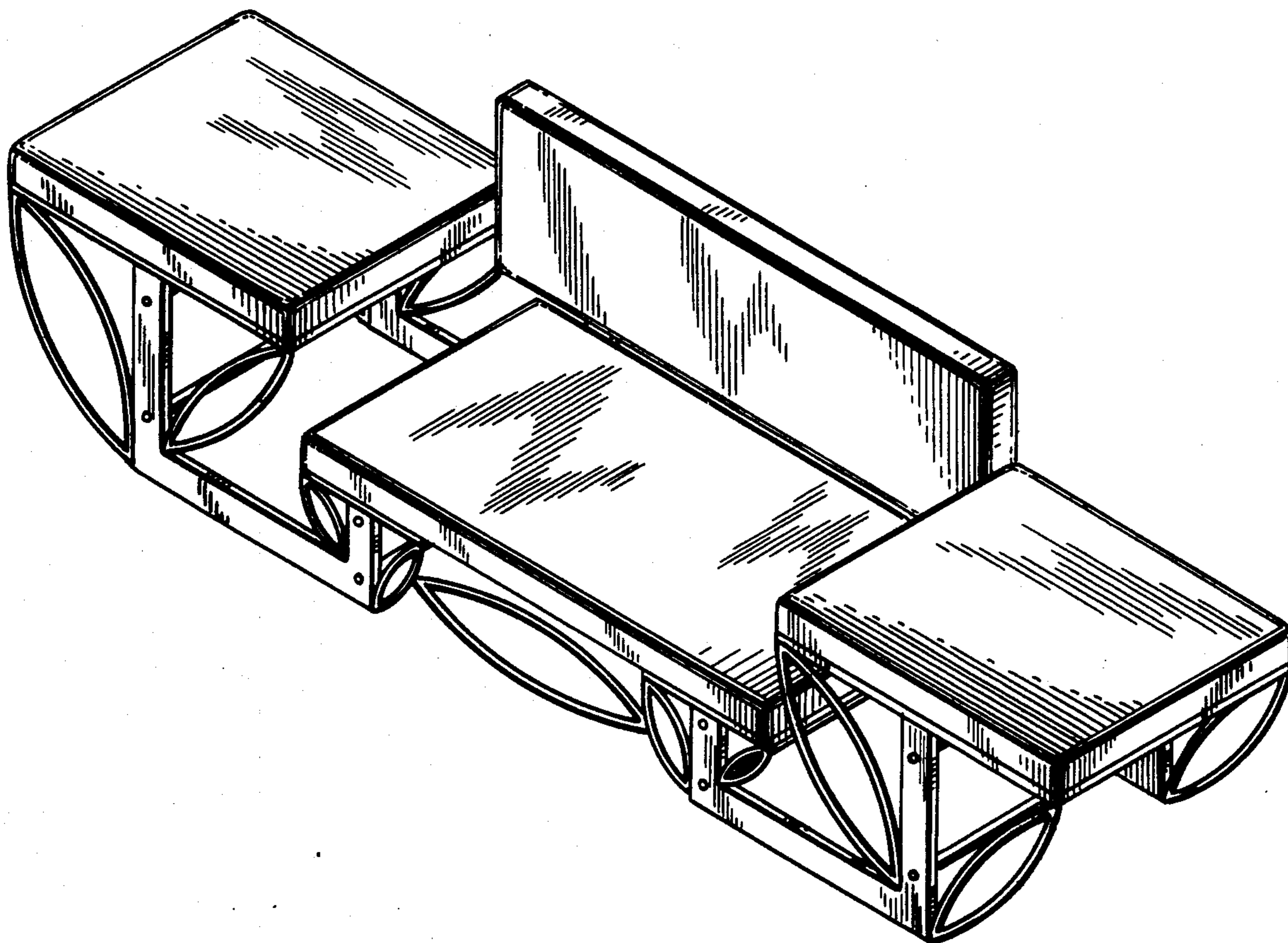

FIG. 2

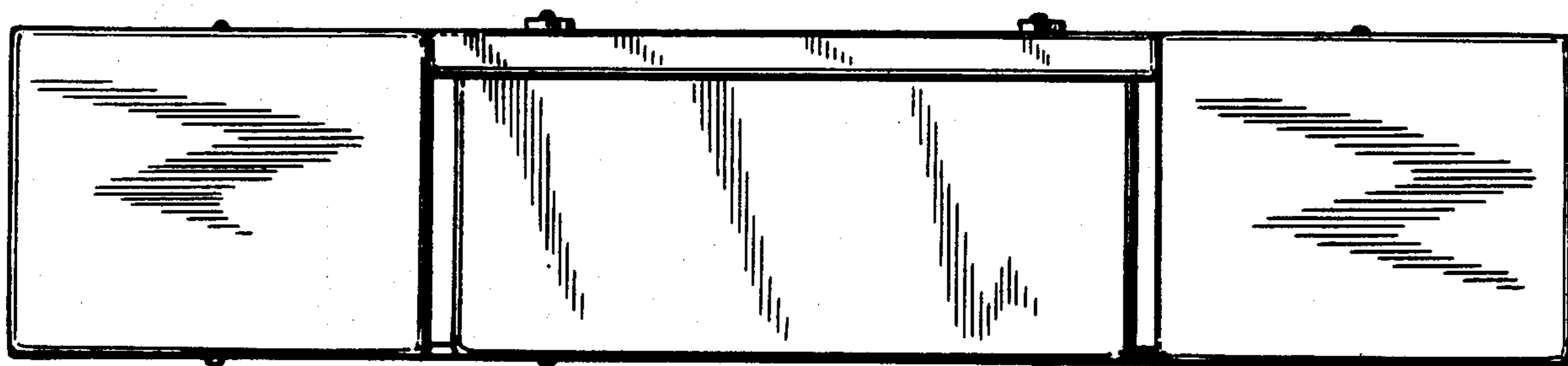

FIG. 3

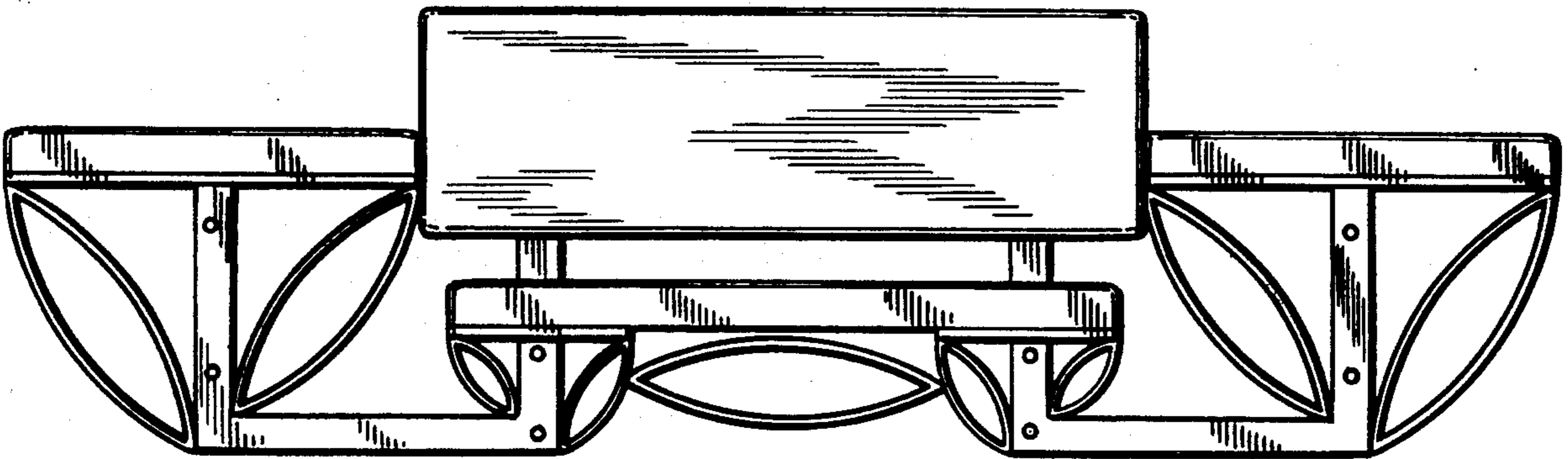

FIG. 4

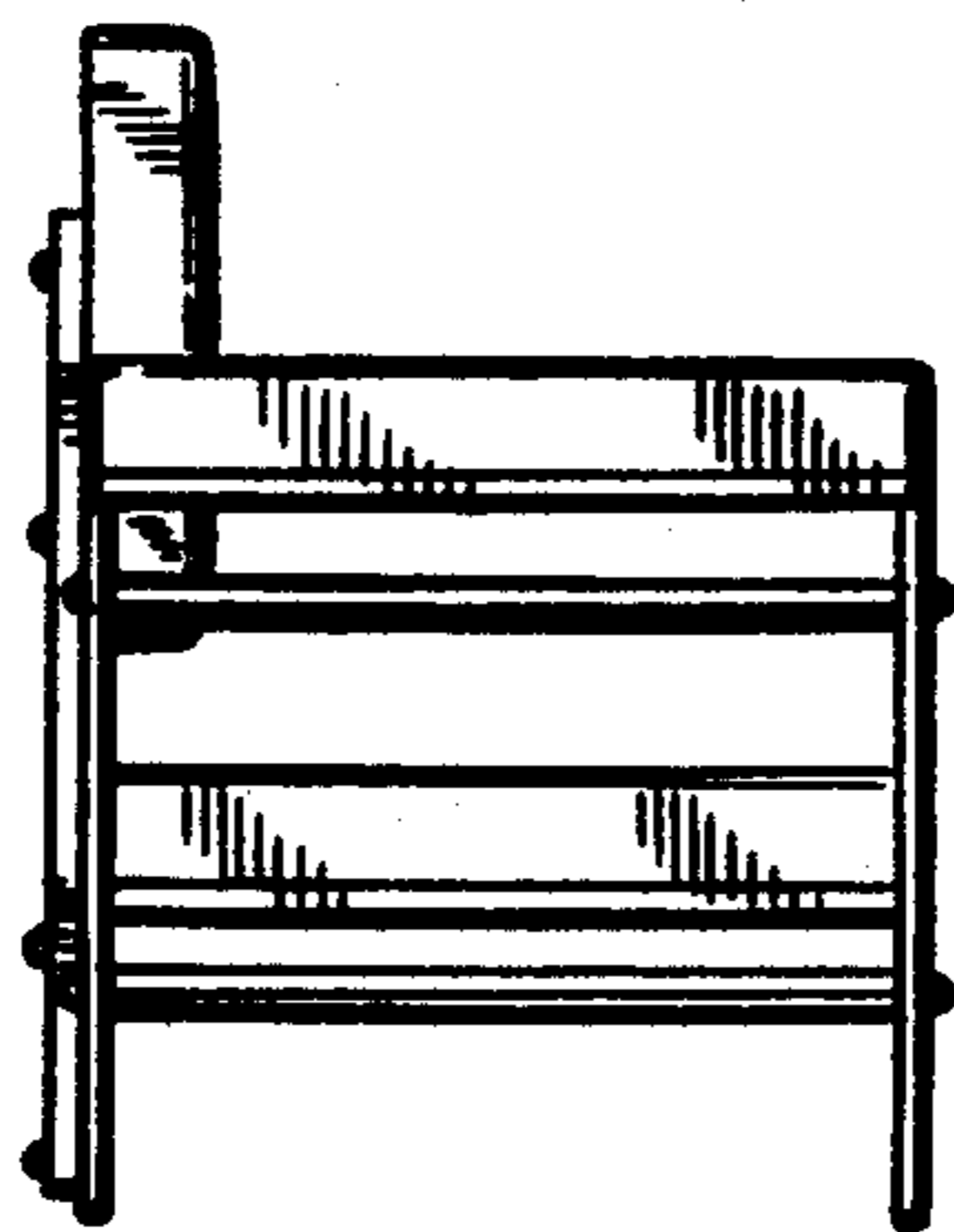

FIG. 5

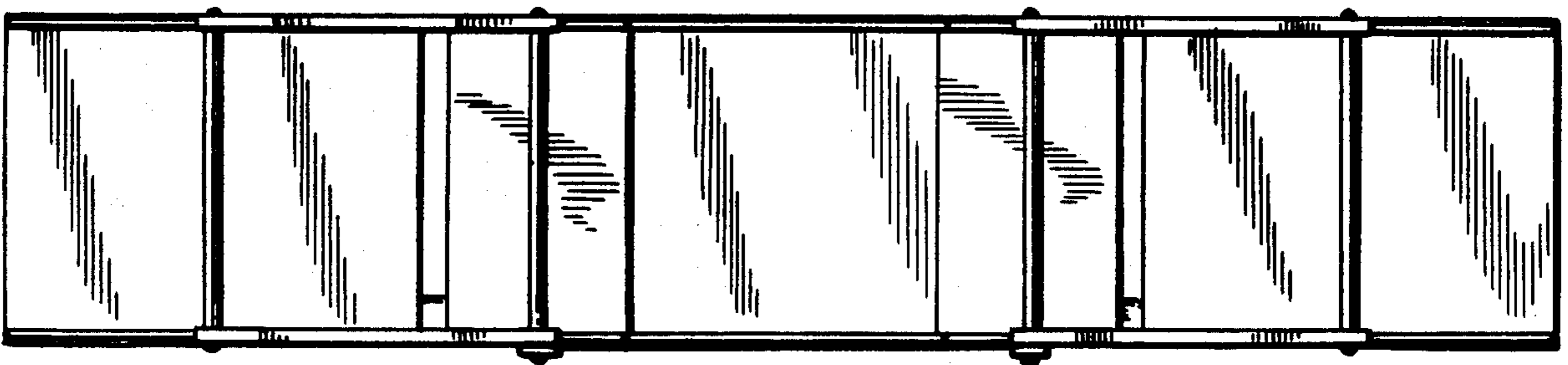

FIG. 6

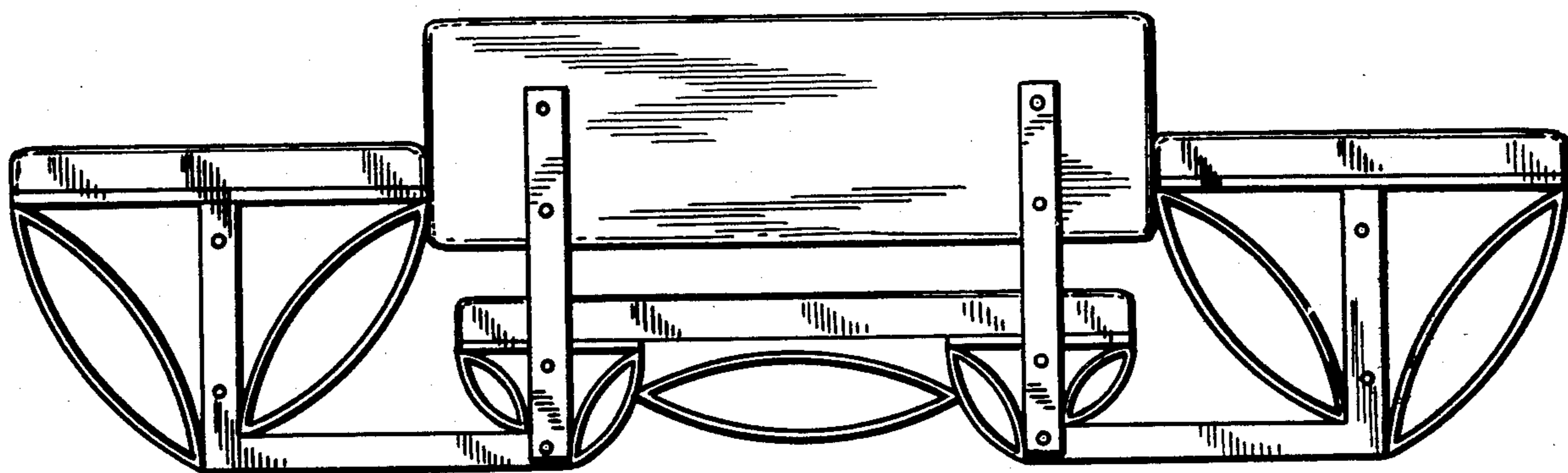

FIG. 7

