

[54] **TIMER**

[75] **Inventors:** Ellworth R. Danz, La Salle; John C. Crenshaw, Joliet, both of Ill.

[73] **Assignee:** General Time Corporation, Thomaston, Conn.

[\*\*] **Term:** 14 Years

[21] **Appl. No.:** 783,690

[22] **Filed:** Apr. 1, 1977

[51] **Int. Cl.** ..... D10-03

[52] **U.S. Cl.** ..... D10/40

[58] **Field of Search** ..... D10/30, 40; 58/37.5, 58/21.13

D. 245,582 8/1977 Mox ..... D10/40  
3,827,232 8/1974 Bassett ..... 58/21.13

**FOREIGN PATENT DOCUMENTS**

1259766 3/1961 France ..... D10/30 X

**OTHER PUBLICATIONS**

Modern Plastics - 9/53-p. 107-Timer.

*Primary Examiner*—Nelson C. Holtje  
*Attorney, Agent, or Firm*—Willis H. Taylor, Jr.

[57] **CLAIM**

The ornamental design for a timer, substantially as shown.

**DESCRIPTION**

FIG. 1 is a front perspective view of a timer showing our new design;  
FIG. 2 is a front elevational view thereof;  
FIG. 3 is a side elevational view taken along line 3—3 of FIG. 2;  
FIG. 4 is a top plan view thereof;  
FIG. 5 is a rear elevational view thereof; and  
FIG. 6 is a bottom view thereof.

[56]

**References Cited**

**U.S. PATENT DOCUMENTS**

D. 184,300	1/1959	Boldt	.....	D10/40
D. 192,382	3/1962	Vogt	.....	D10/40
D. 226,631	4/1973	Baker	.....	D10/40
D. 232,920	9/1974	Rodriguez	.....	D10/40
D. 245,320	8/1977	Mox	.....	D10/40

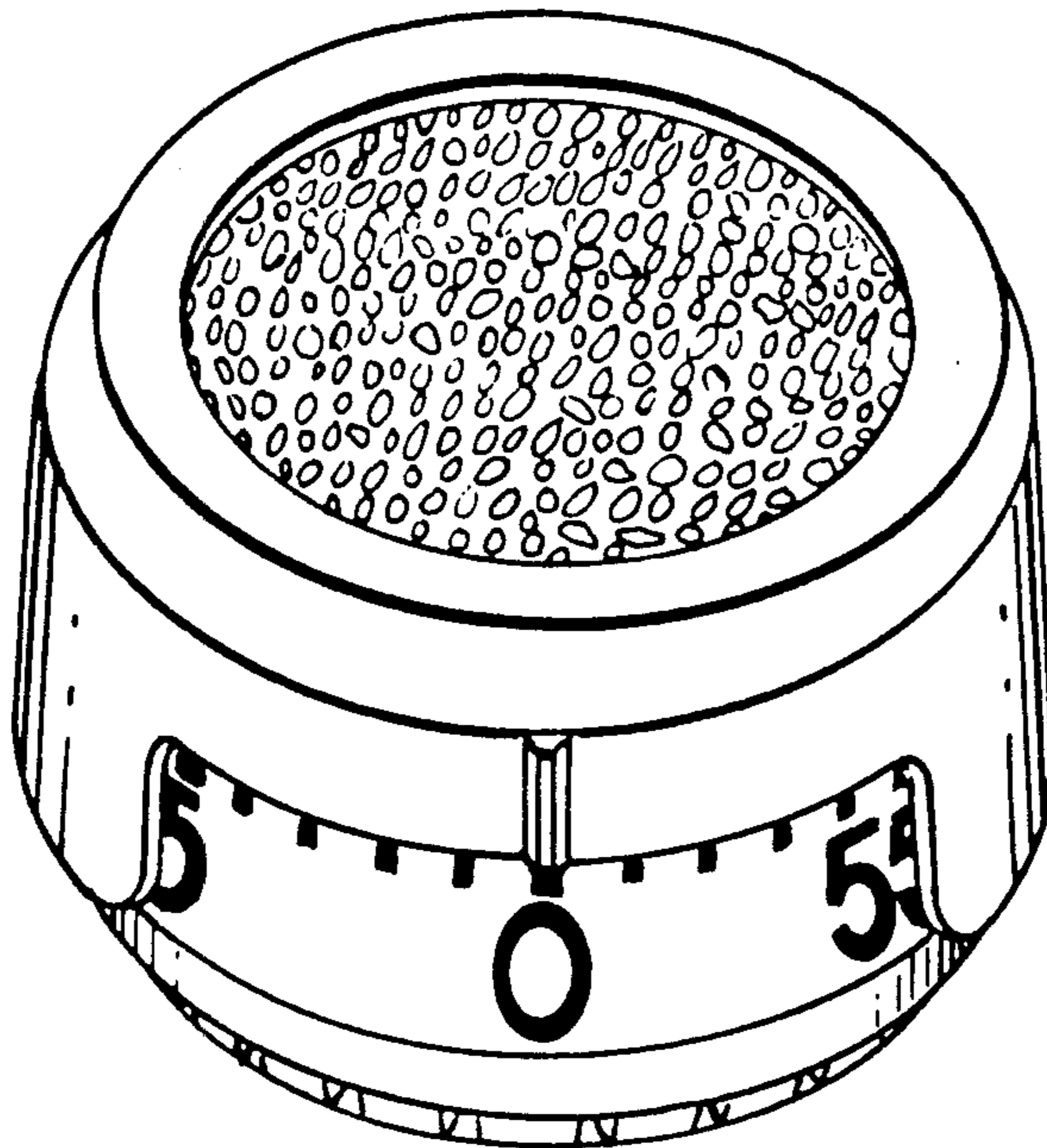

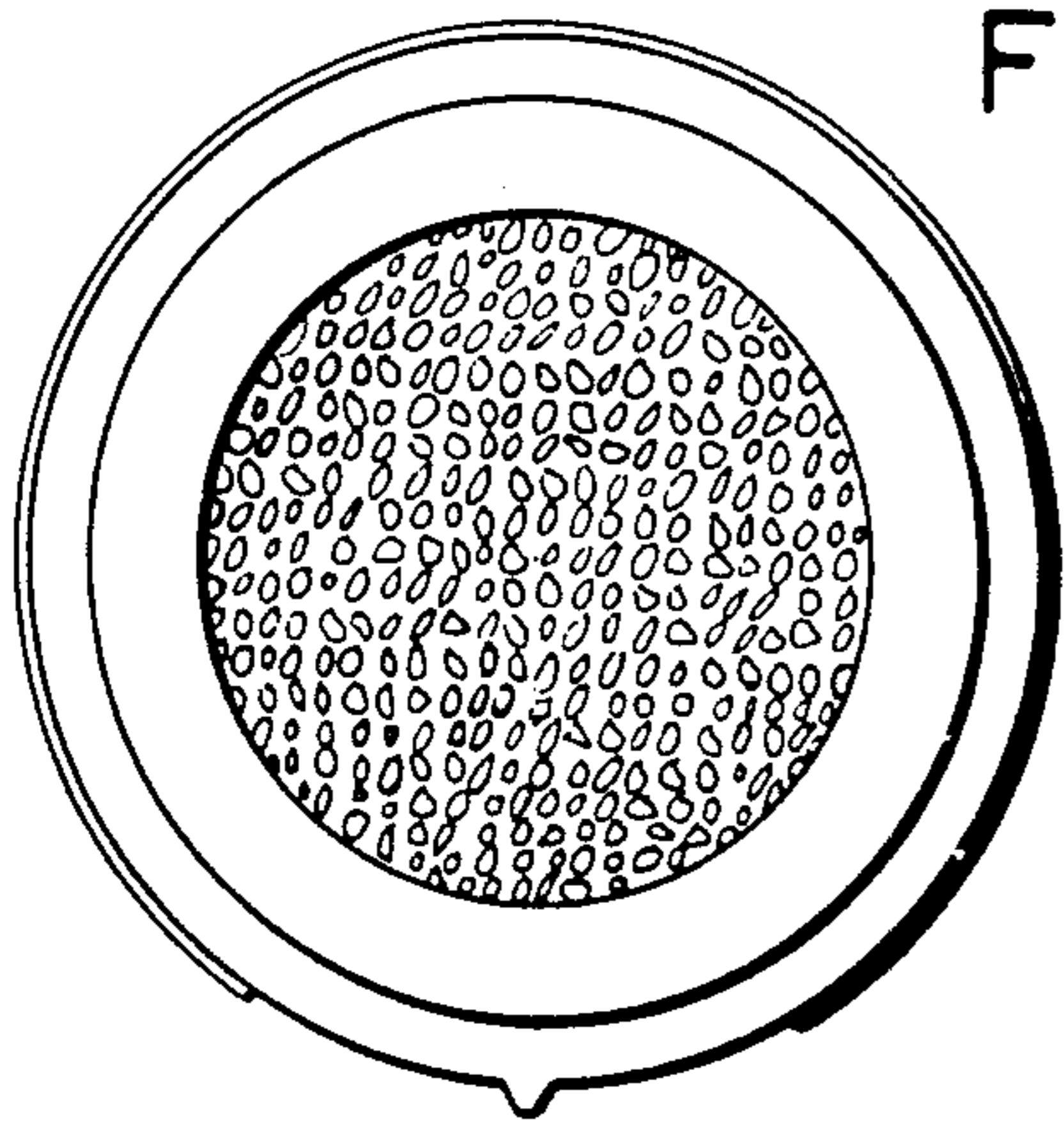

FIG. 4

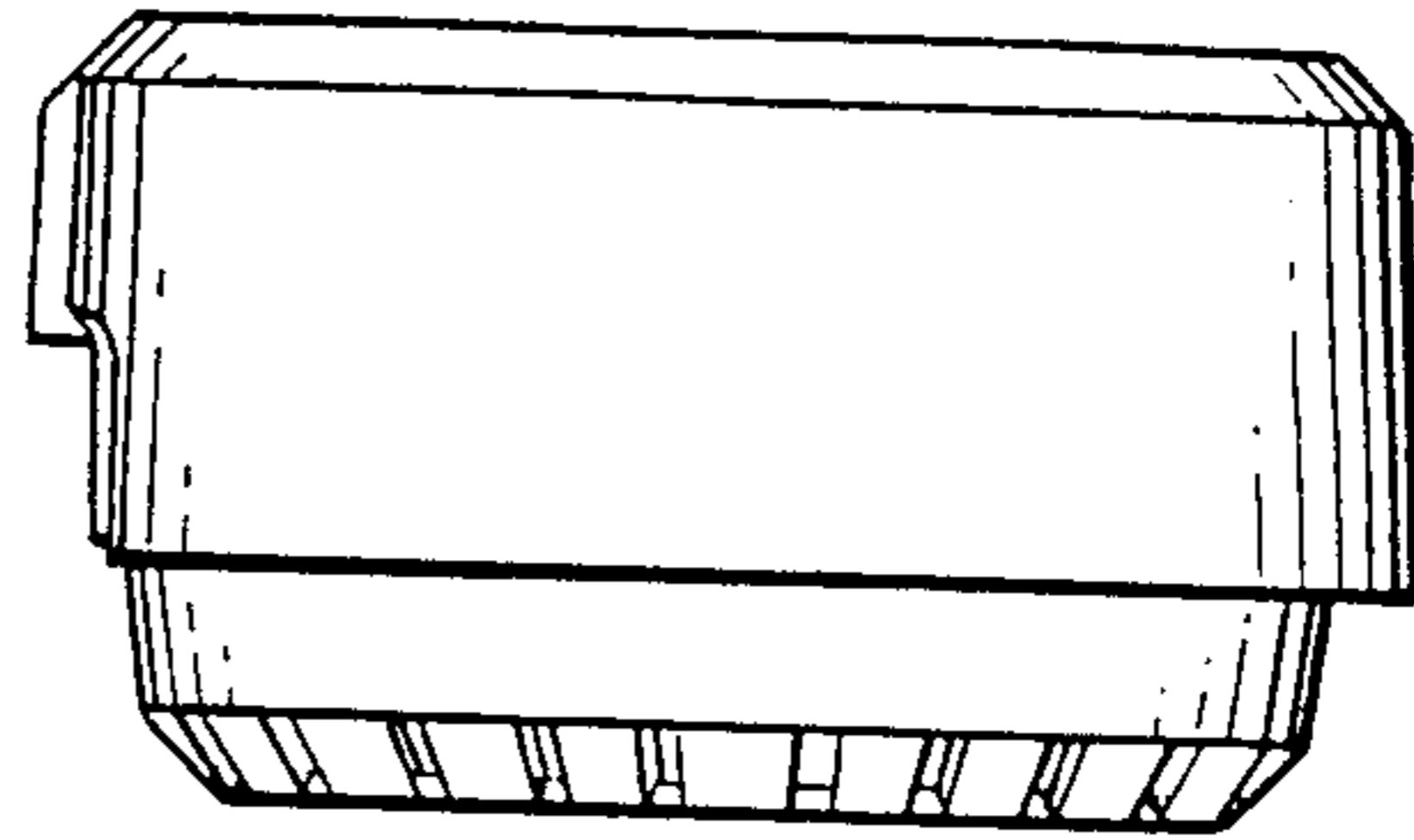

FIG. 3

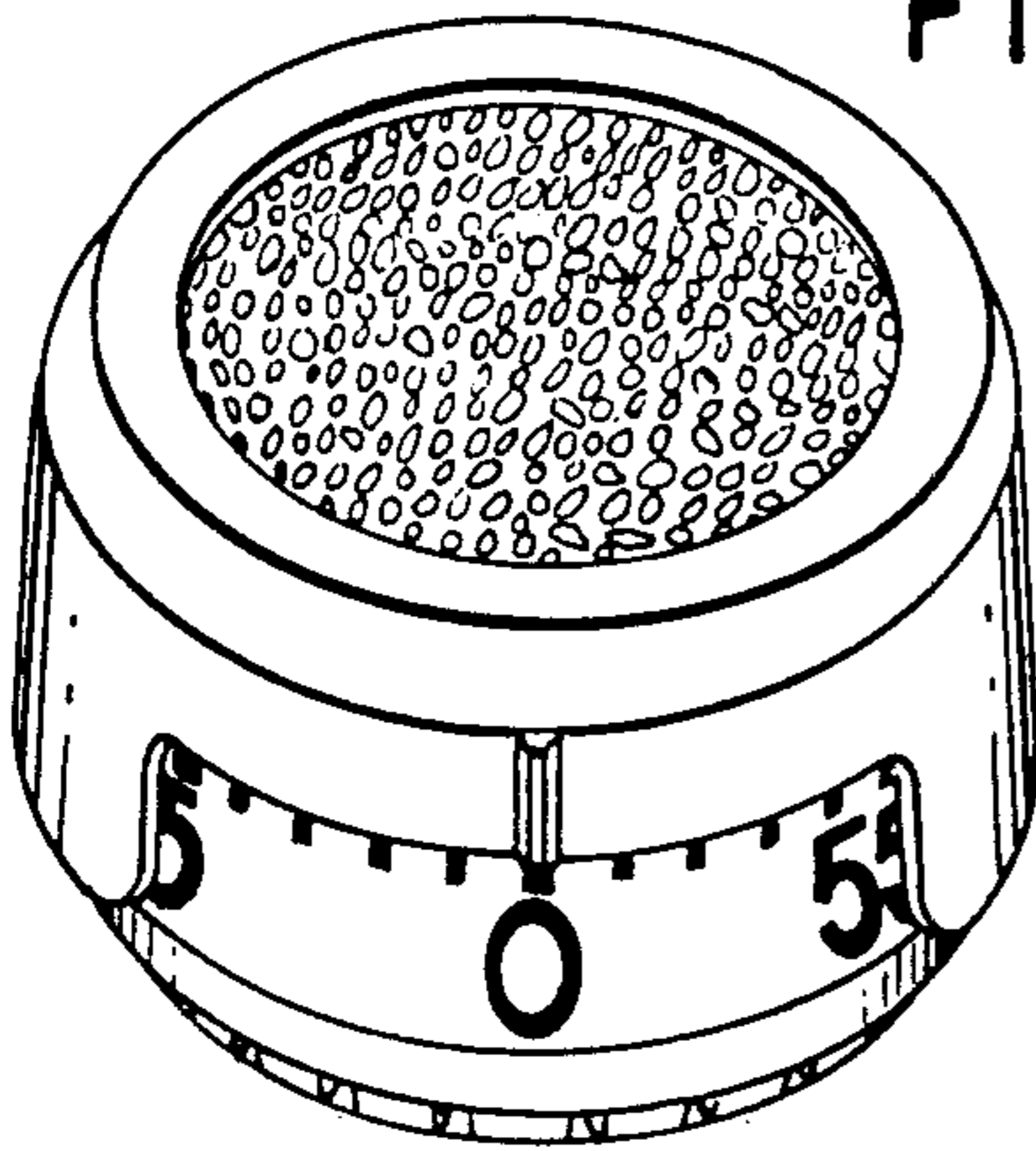

FIG. 1

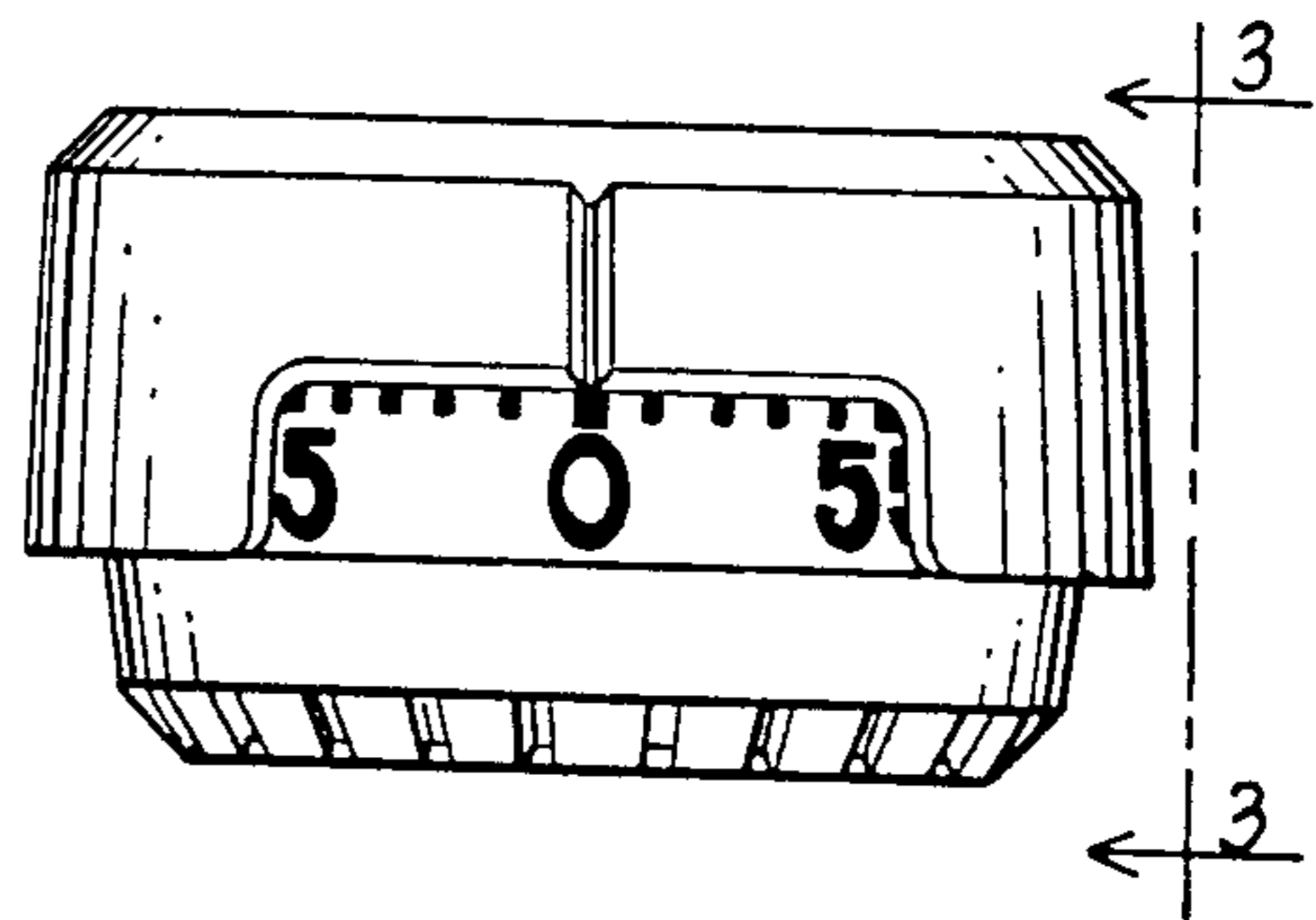

FIG. 2

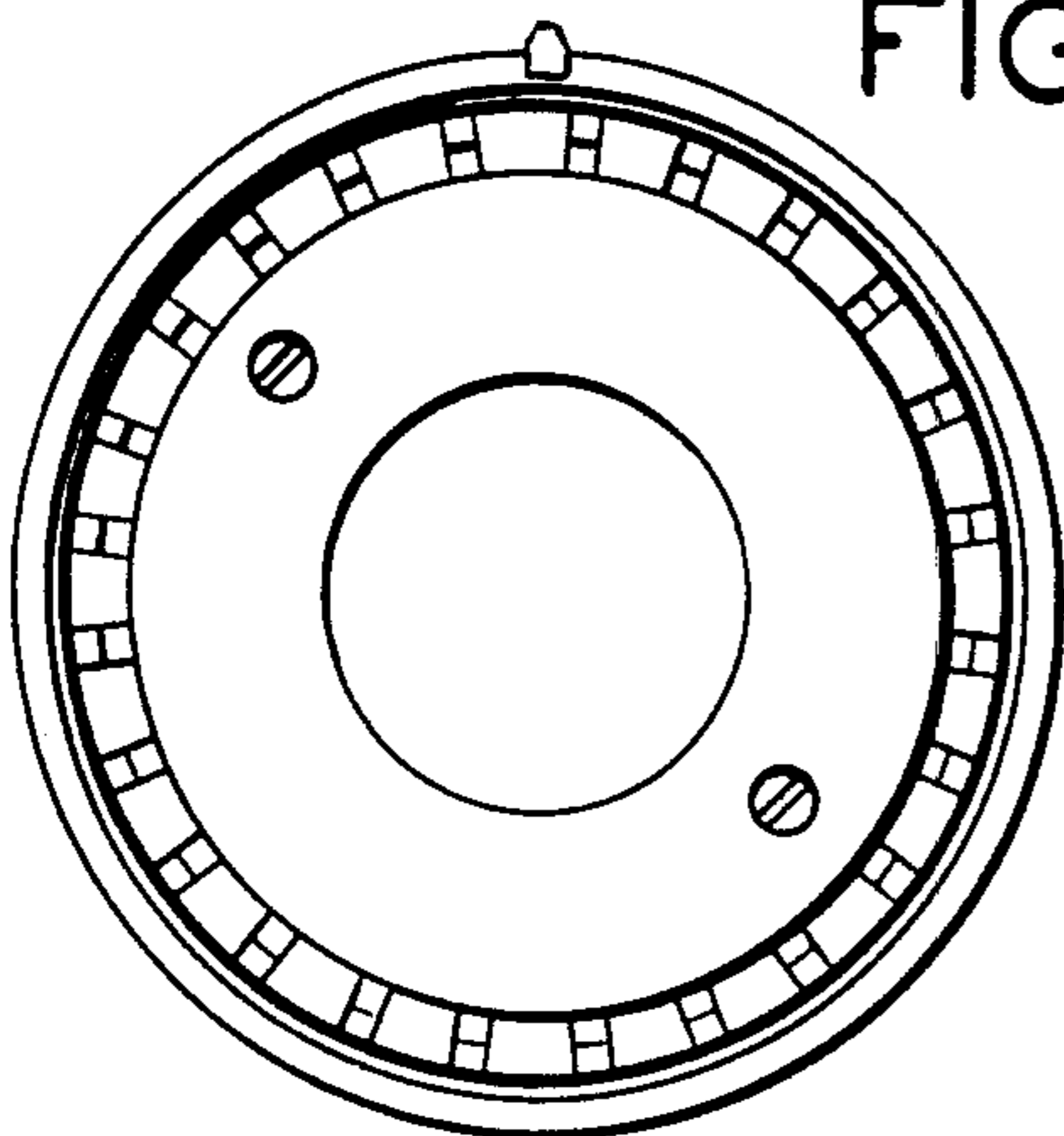

FIG. 6

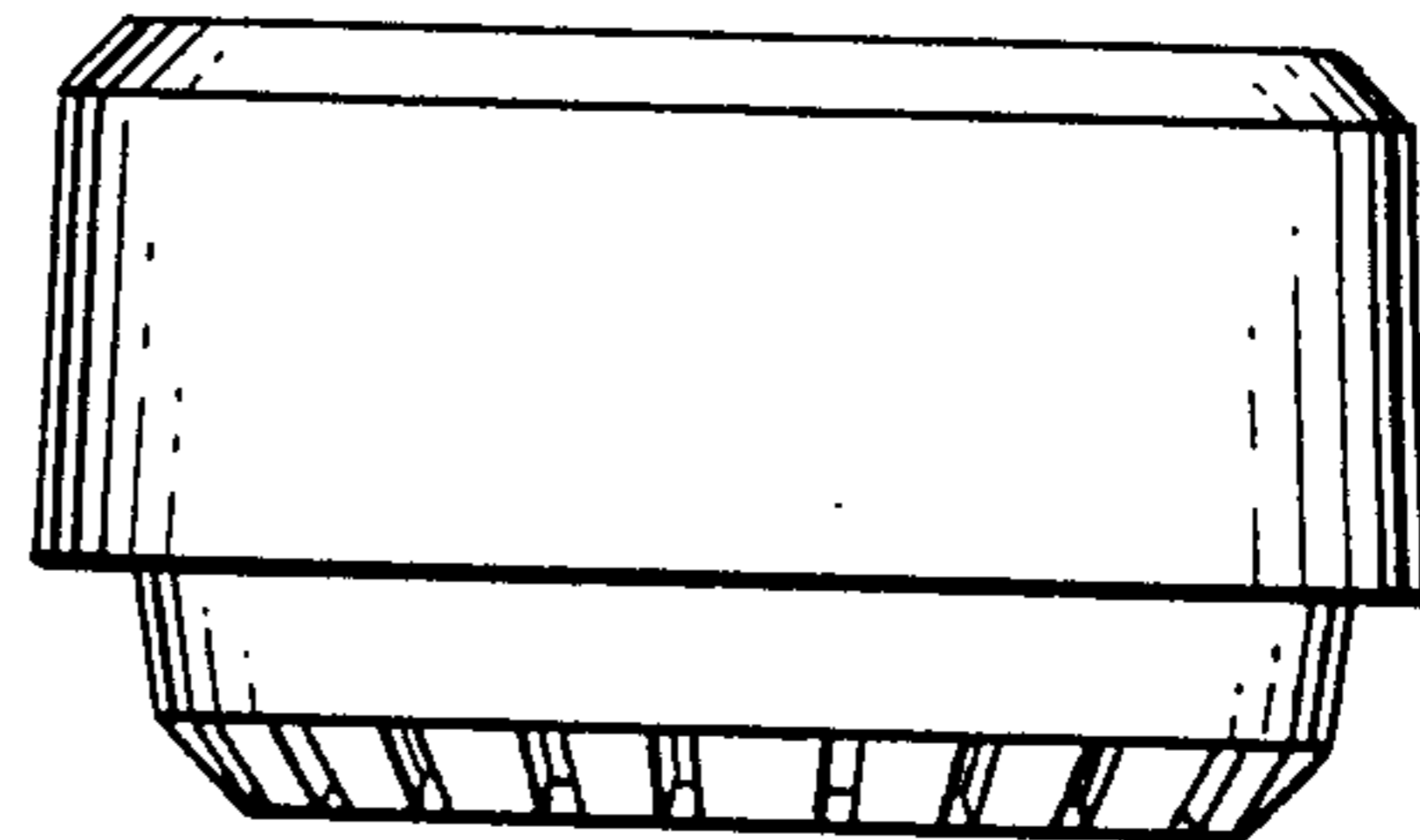

FIG. 5