

[54] ALTERNATOR BRACKET FOR VEHICLES

3,516,627 6/1970 Gable et al. 248/15

[76] Inventors: Paul N. Mygind, 5567 Airways Ave., Fresno, Calif. 93727; Floyd E. Gross, 6468 N. 7th St., Fresno, Calif. 93710

Primary Examiner—A. Hugo Word
Attorney, Agent, or Firm—Eugene M. Eckelman

[**] Term: 14 Years

[57] CLAIM

[21] Appl. No.: 775,270

The ornamental design for an alternator bracket for vehicles, as shown.

[22] Filed: Mar. 7, 1977

DESCRIPTION

[51] Int. Cl.² D8—08

FIG. 1 is a top plan view of an alternator bracket for vehicles showing our new design;

[52] U.S. Cl. D8/380; D8/354; D8/363; D8/366

FIG. 2 is a side elevational view taken on the line 2—2 of FIG. 1;

[58] Field of Search D8/354, 363, 373, 380; 248/3, 14, 15, 16

FIG. 3 is a bottom plan view taken on the line 3—3 of FIG. 2;

[56] References Cited

FIG. 4 is a side elevational view taken on the line 4—4 of FIG. 1;

U.S. PATENT DOCUMENTS

FIG. 5 is an end elevational view taken on the line 5—5 of FIG. 1; and

D. 204,809 5/1966 Neill D8/380
D. 244,748 6/1977 Canterburg D8/380

FIG. 6 is an end elevational view taken on the line 6—6 of FIG. 1.

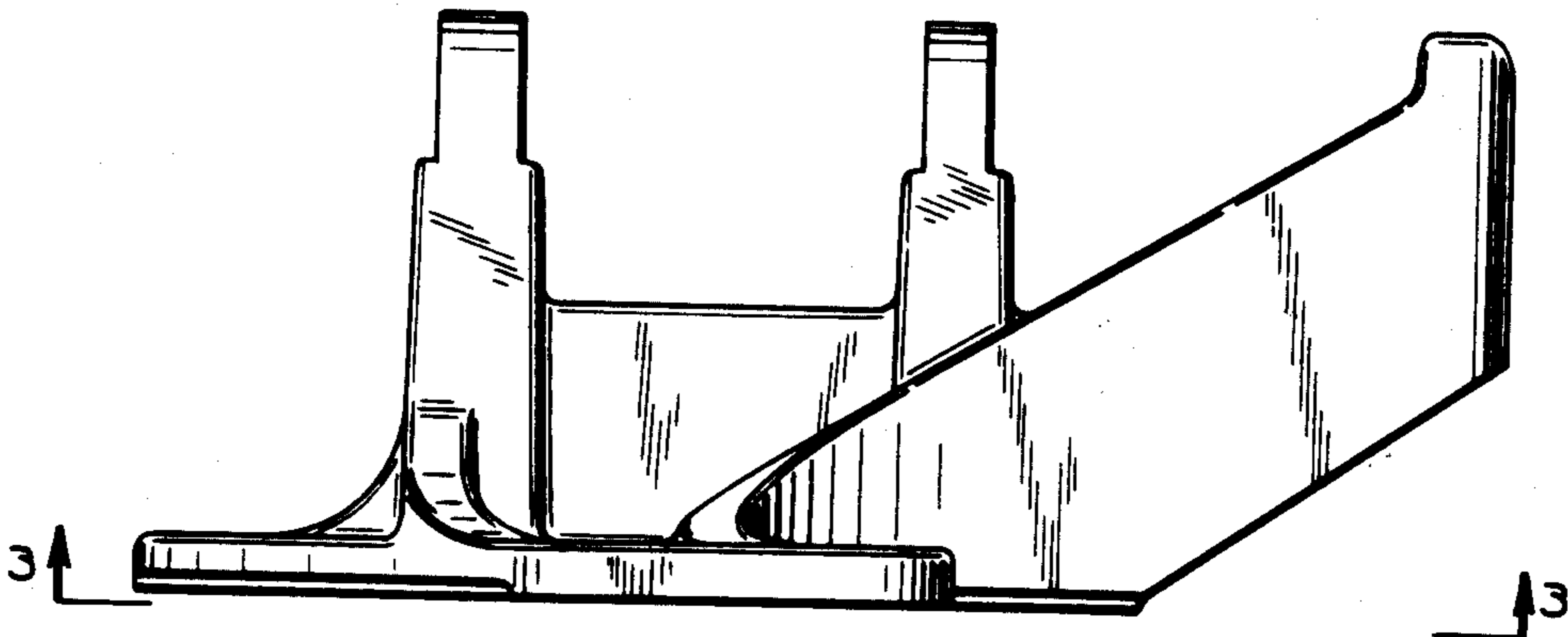

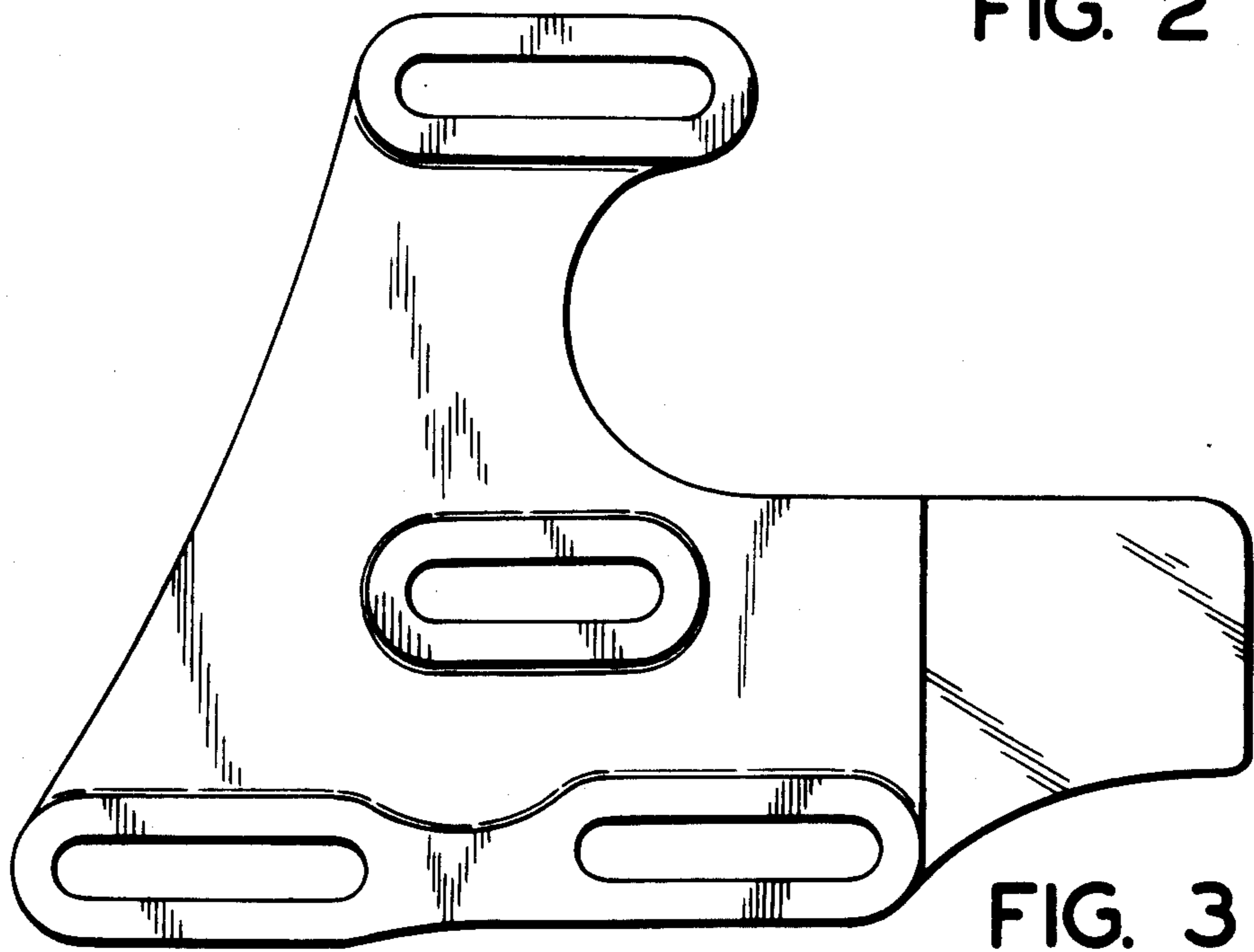
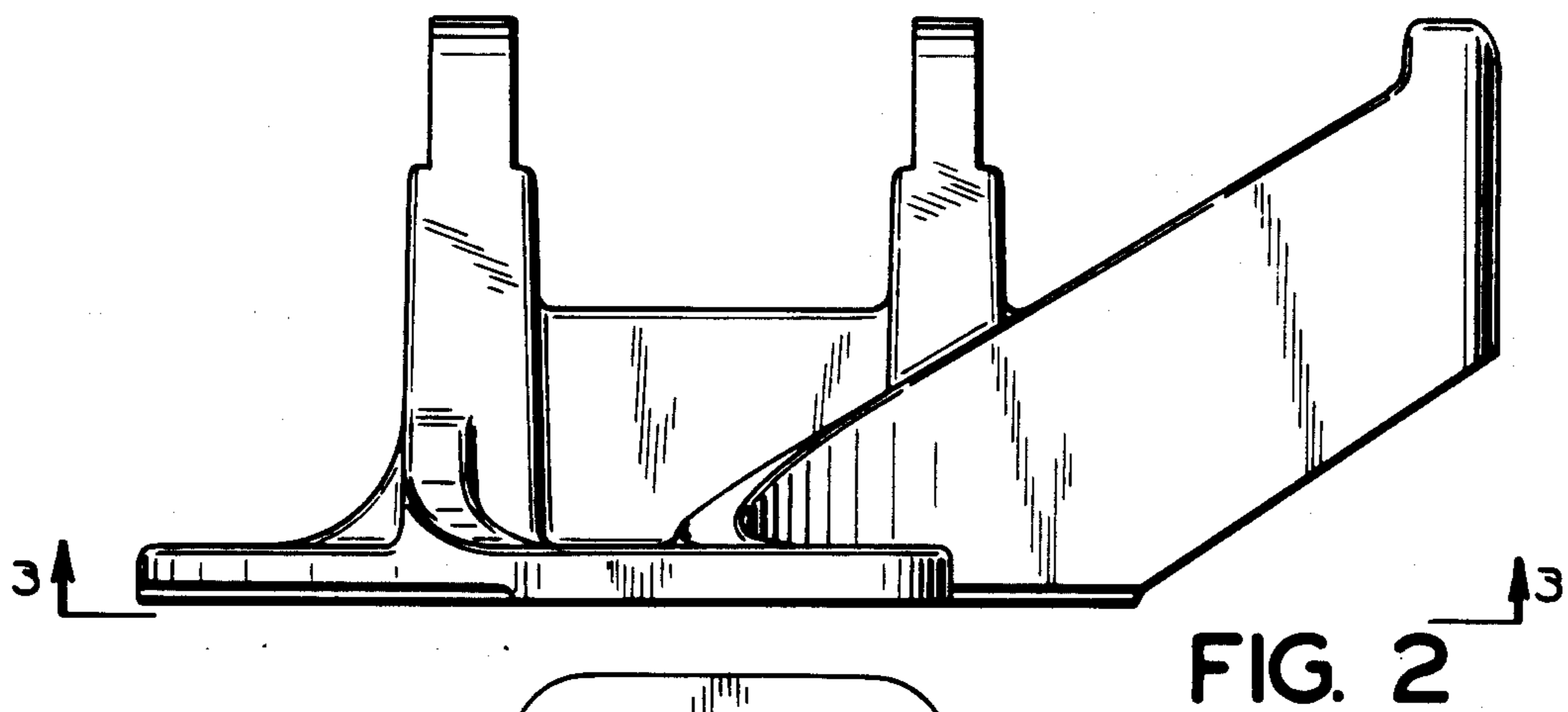
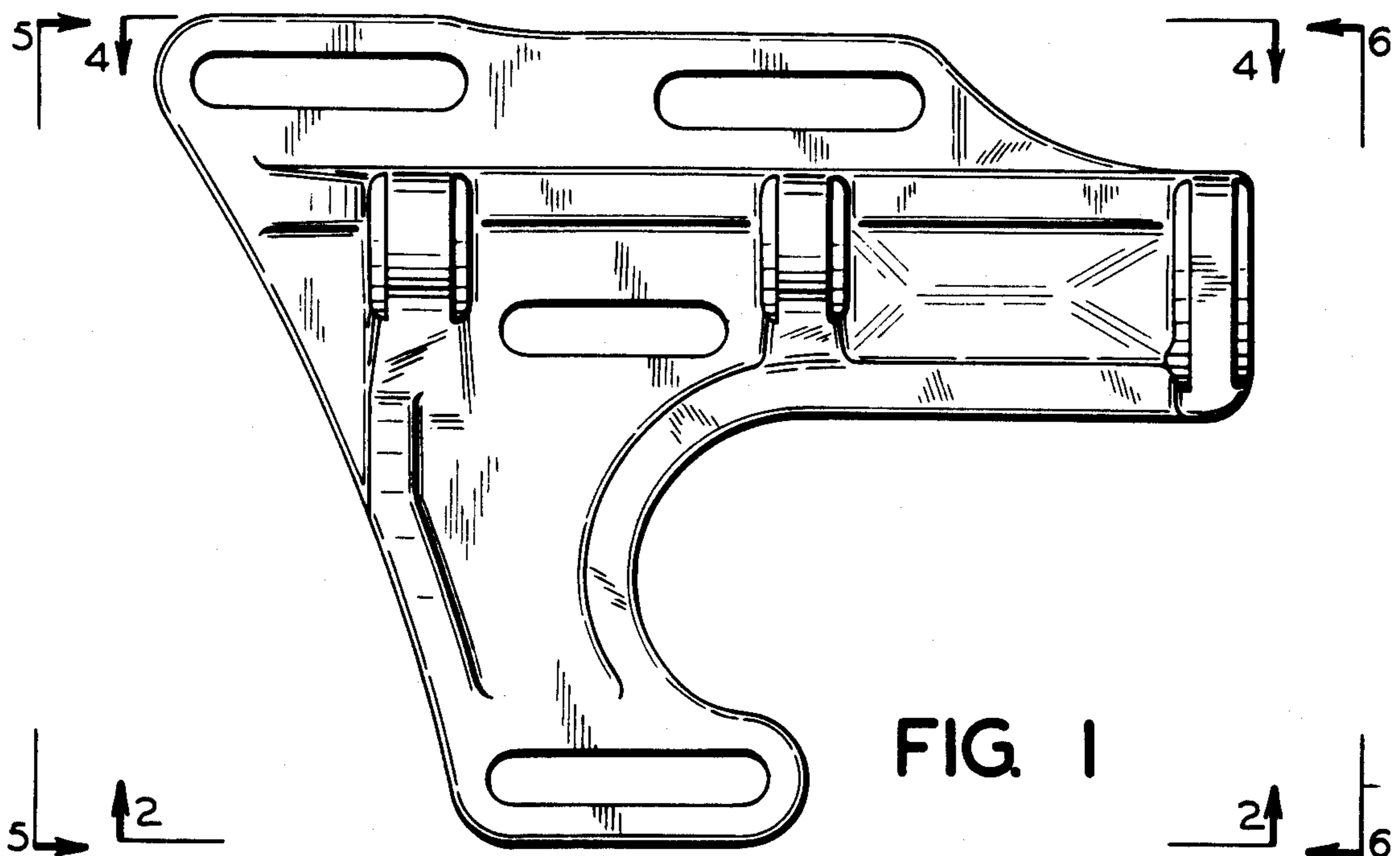

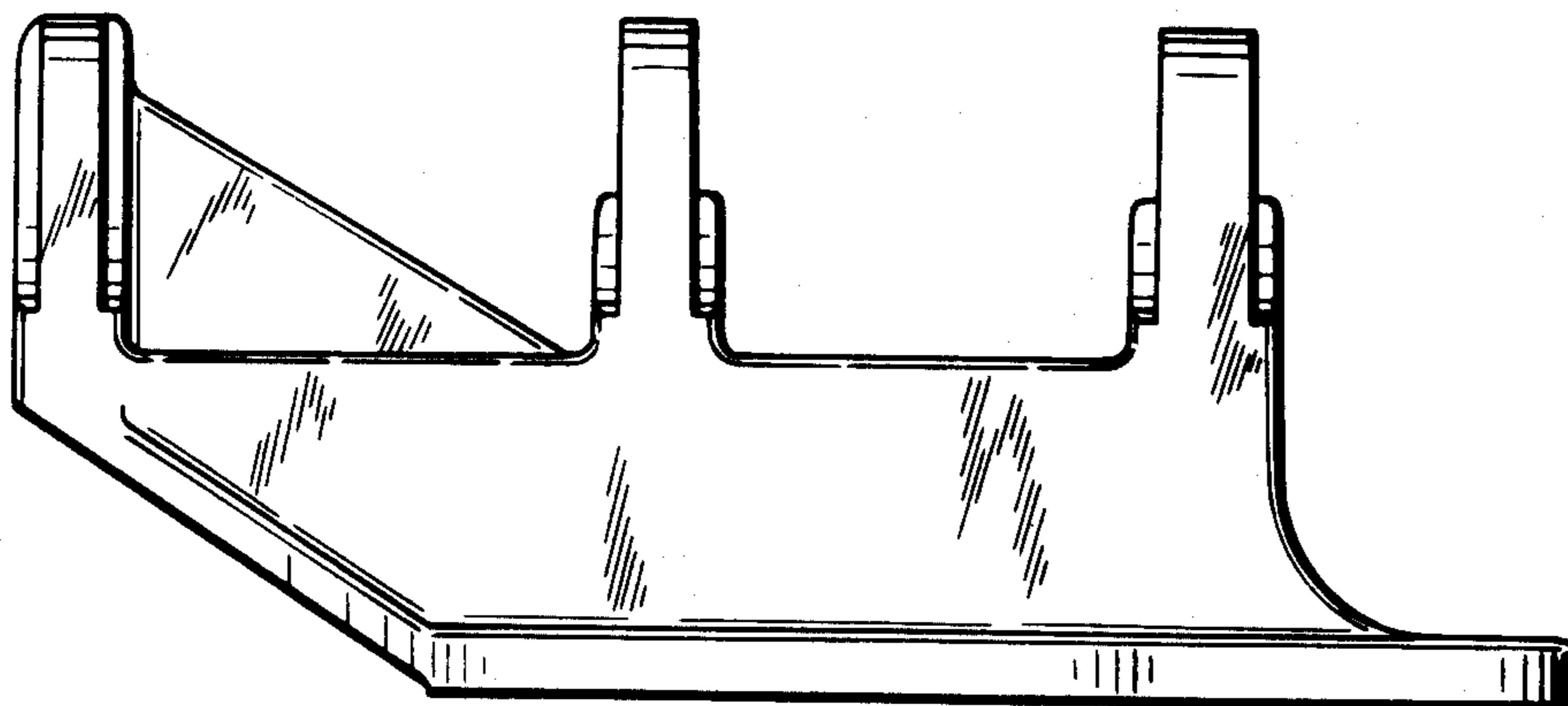

FIG. 4

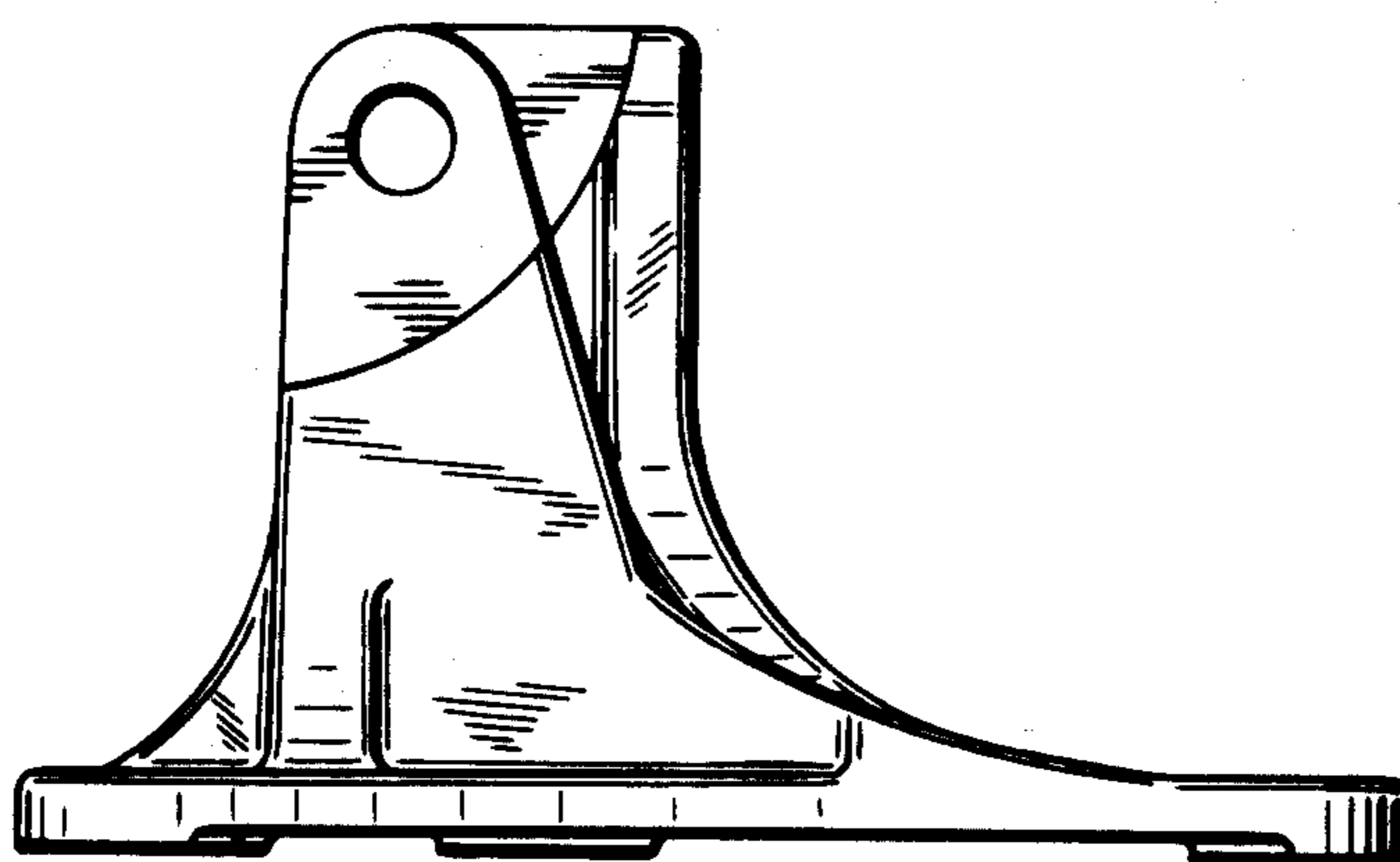

FIG. 5

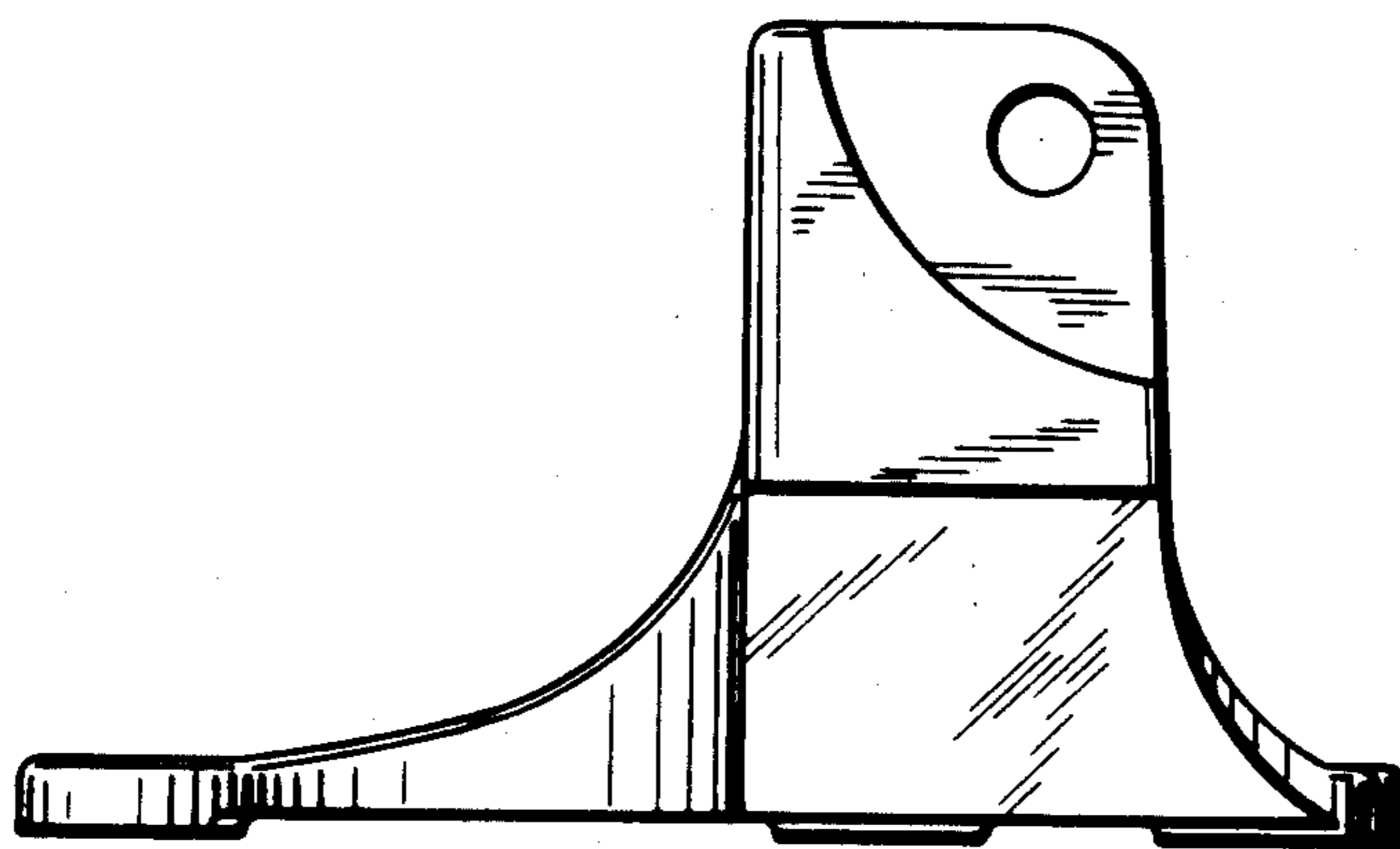

FIG. 6