

[54] COMBINED DISPLAY AND KEYBOARD TERMINAL

[75] Inventors: William N. Mayer, White Bear Lake; Richard K. Kirchner, Bloomington; Nicholas C. Andreadakis, White Bear Lake, all of Minn.

[73] Assignee: Modern Controls Inc., Minneapolis, Minn.

[**] Term: 14 Years

[21] Appl. No.: 743,694

[22] Filed: Nov. 22, 1976

[51] Int. Cl. D14-02

[52] U.S. Cl. D14/43

[58] Field of Search D14/40, 41, 42, 43, D14/44, 45, 46, 47, 50; D13/40, 41; D64/11 R, 11 B, 11 C

[56] References Cited

U.S. PATENT DOCUMENTS

- D. 215,847 11/1969 Glover et al. D14/45
- D. 222,883 1/1972 Levow et al. D14/45

OTHER PUBLICATIONS

Modern Data, Oct. 1975, p. 26-Portable terminal.

Primary Examiner—Susan J. Lucas
Attorney, Agent, or Firm—Paul L. Sjoquist

[57] CLAIM

The ornamental design for a combined display and keyboard terminal, substantially as shown and described.

DESCRIPTION

FIG. 1 is an isometric view of the combined display and keyboard terminal in an opened position; FIG. 2 is an isometric view thereof in a closed position; FIG. 3 is a right side elevational view; FIG. 4 is a rear elevational view thereof; FIG. 5 is a bottom plan view thereof; and FIG. 6 is a front elevational view thereof.

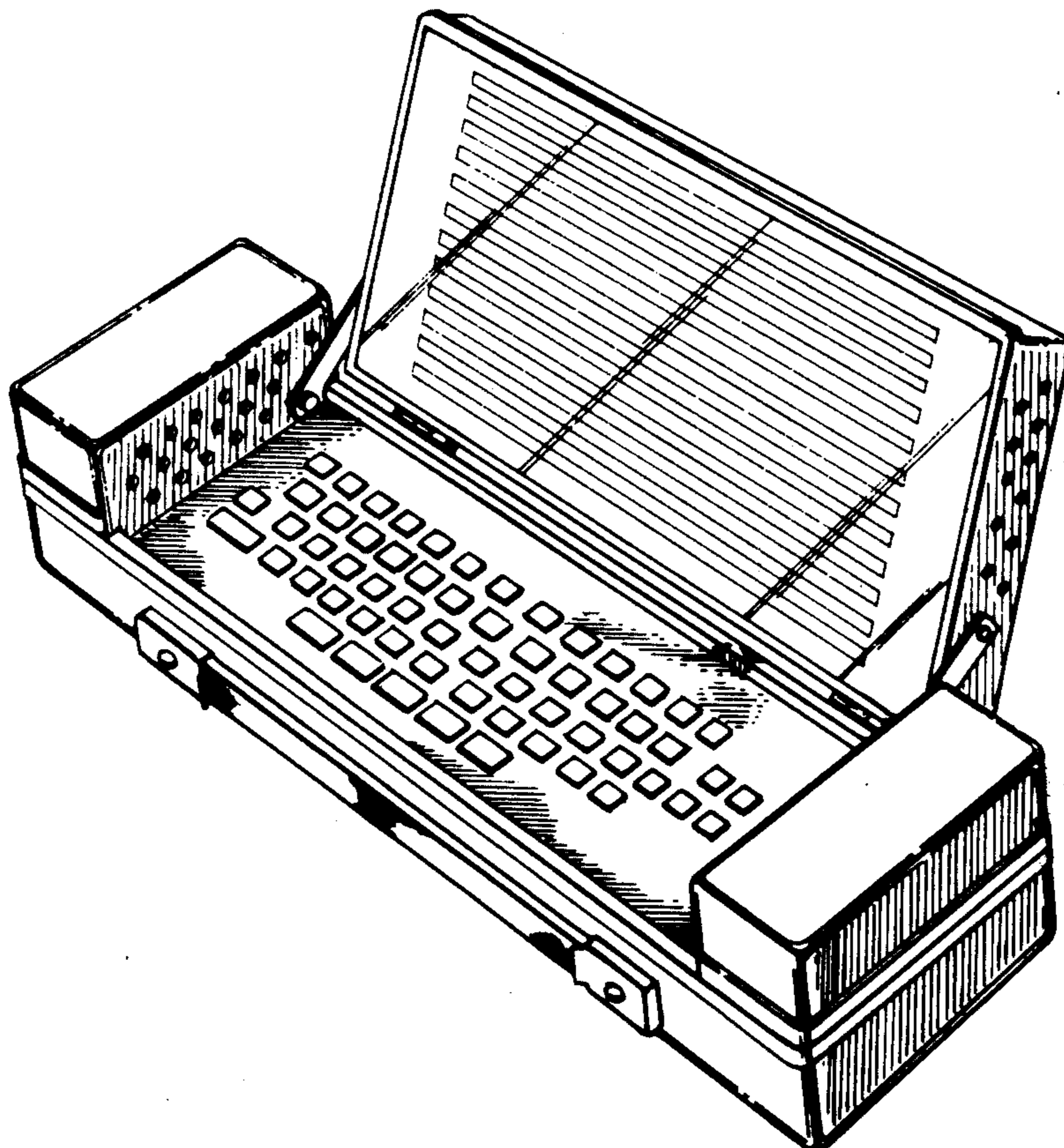

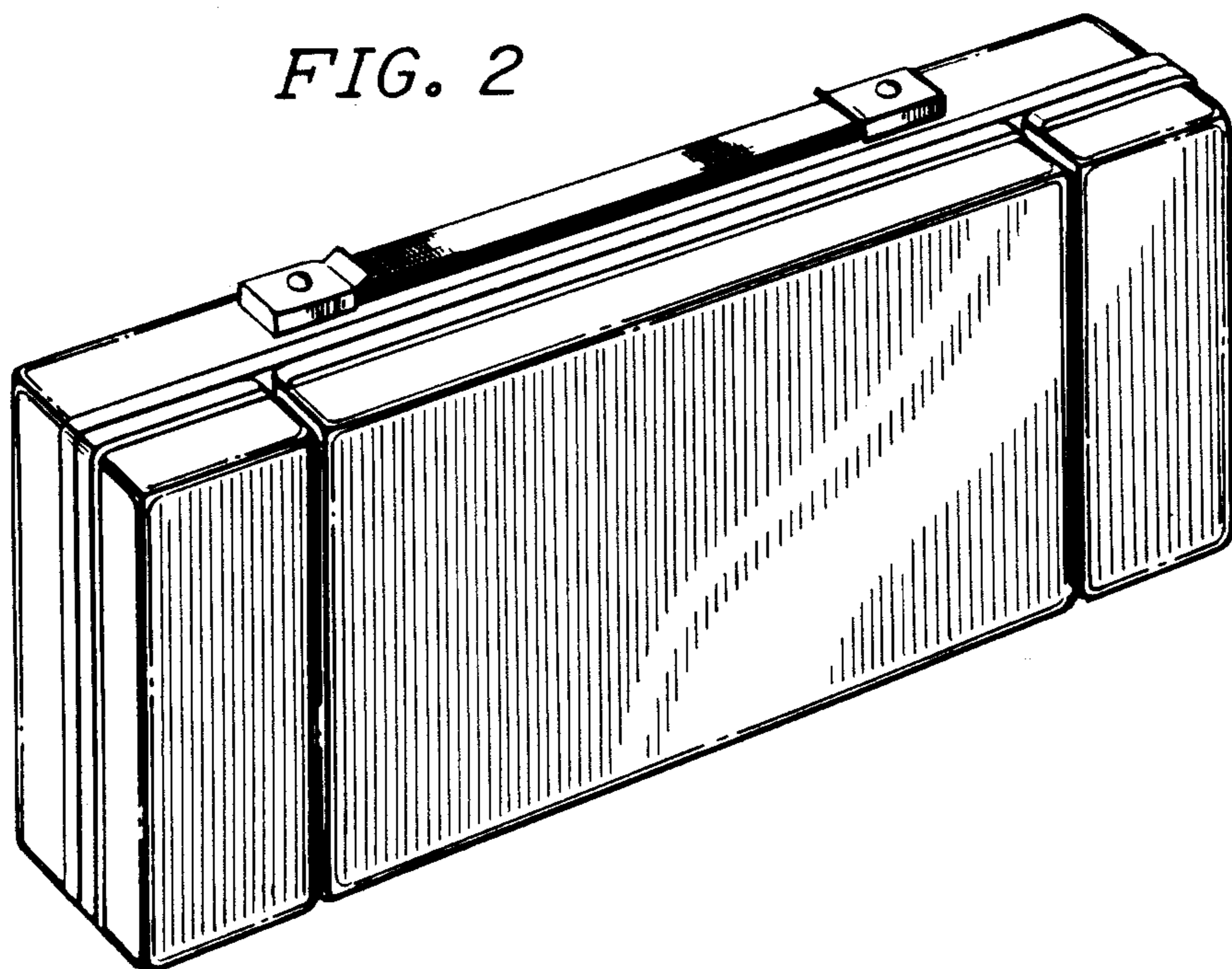
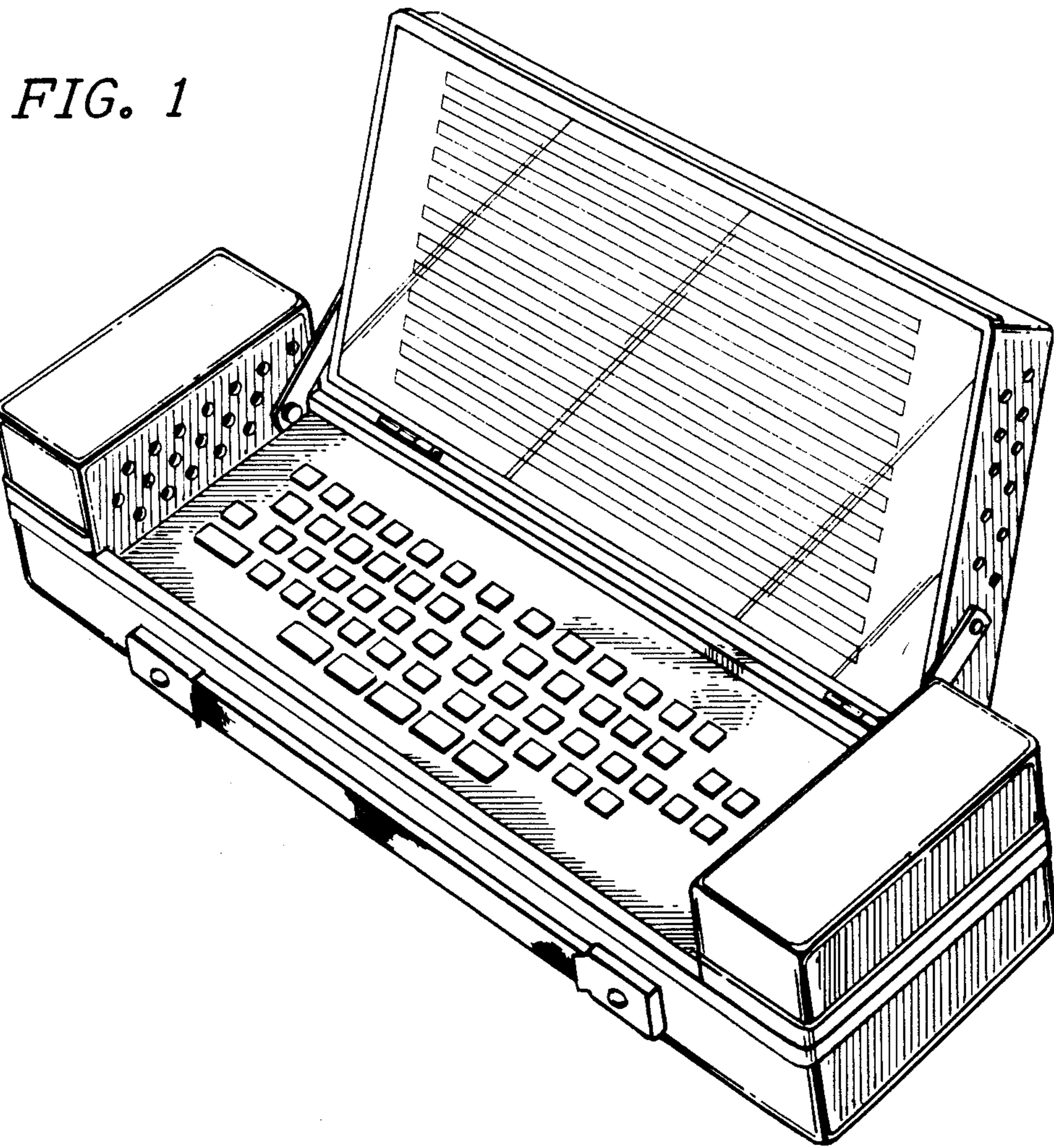

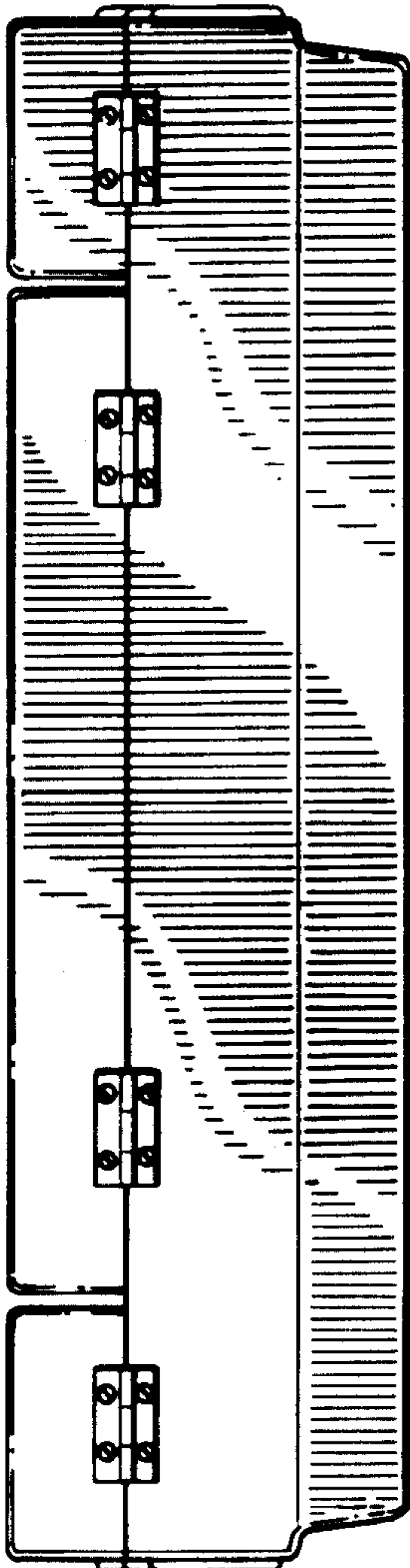

FIG. 4

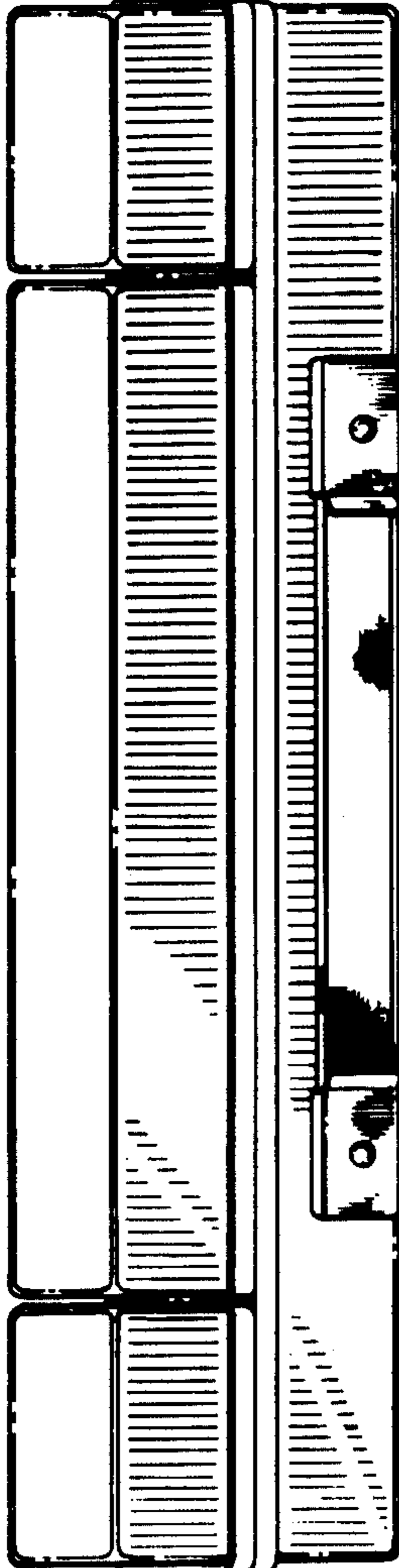

FIG. 6

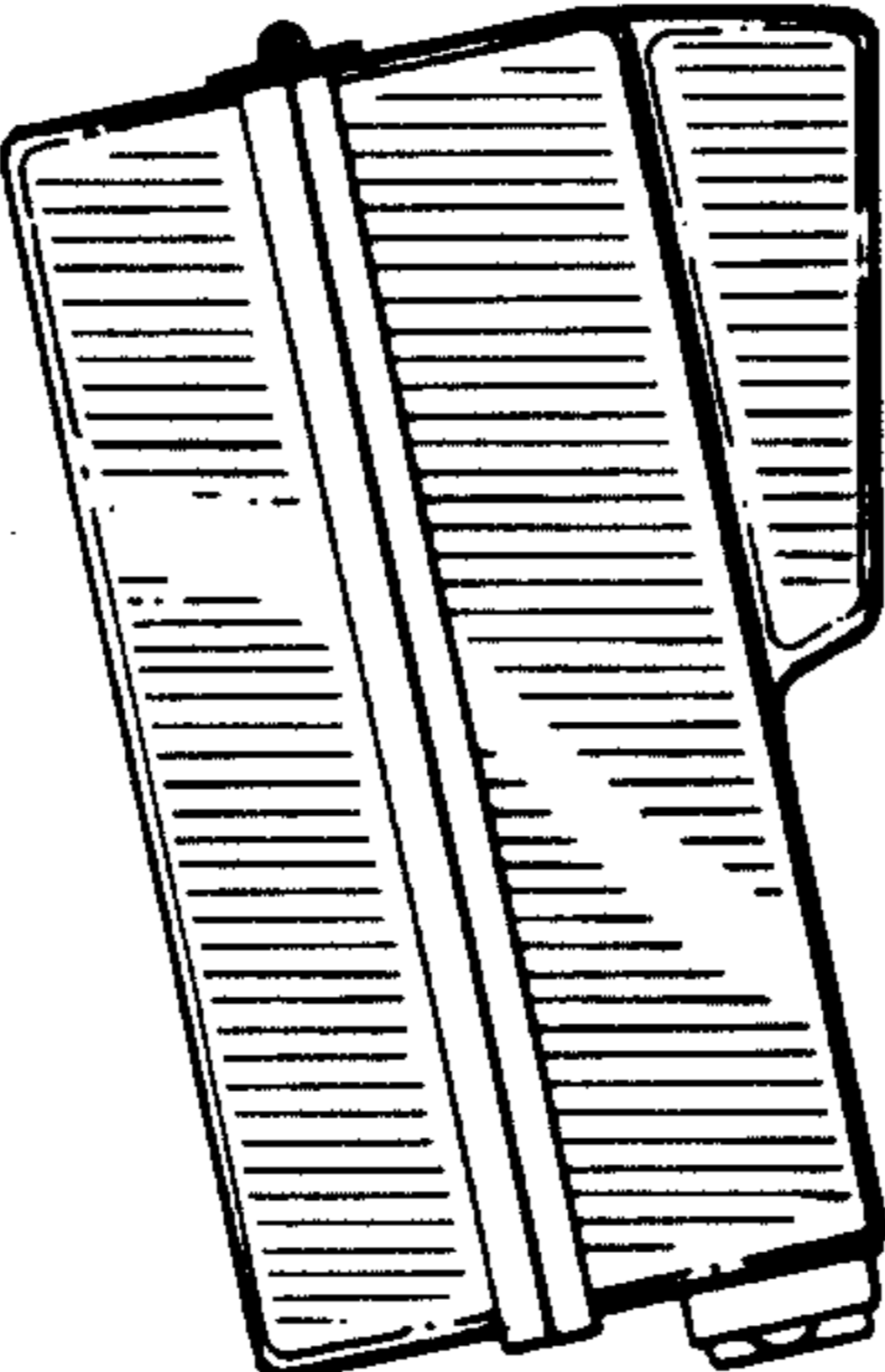

FIG. 3

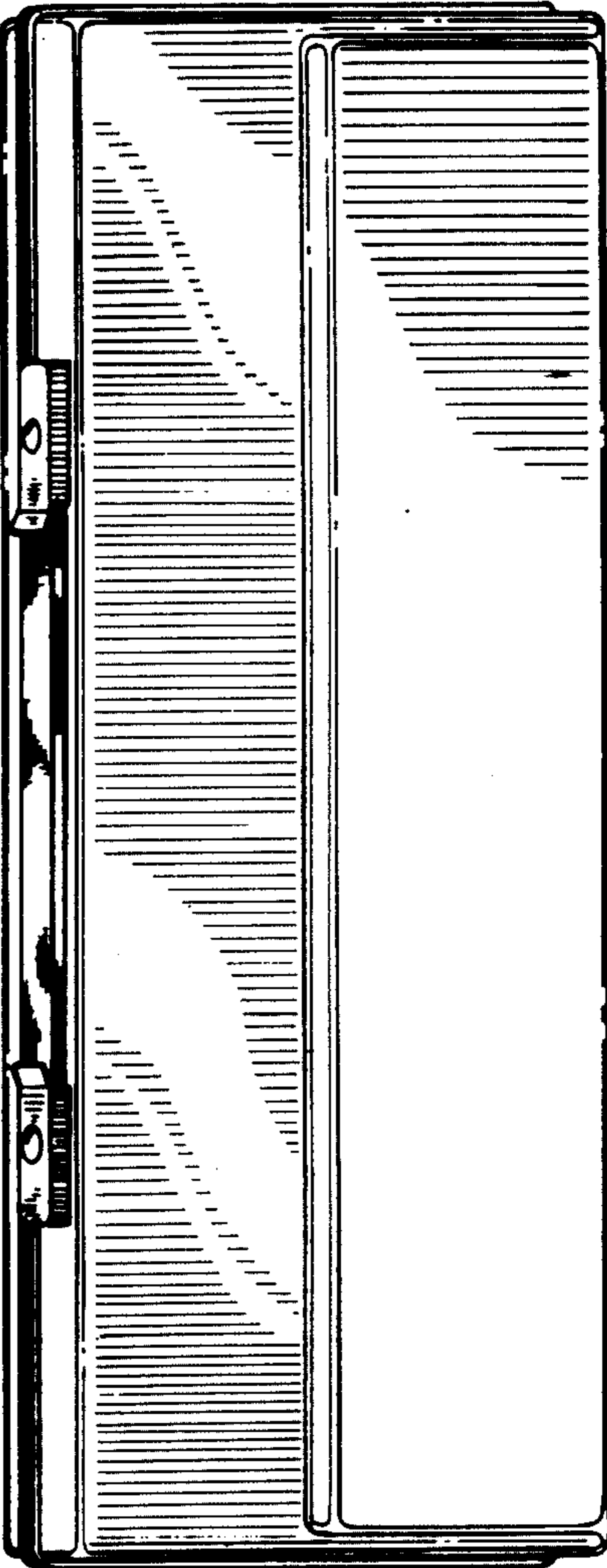

FIG. 5