

[54] HAND-HELD SPOTLIGHT

[76] Inventor: John B. Brinkmann, 3525 Turtle Creek, Dallas, Tex. 75219

[**] Term: 14 Years

[21] Appl. No.: 805,621

[22] Filed: Jun. 10, 1977

[51] Int. Cl. D26-04; D26-02

[52] U.S. Cl. D48/20 K; D48/24 R

[58] Field of Search D48/24 R, 24 A, 20 K; 362/158, 157, 161, 164, 183, 184, 187, 188, 189, 190, 191, 194, 196, 201, 202, 203, 204, 205, 208

[56] References Cited

U.S. PATENT DOCUMENTS

D. 224,556	8/1972	Chan	D48/24 R
1,273,851	7/1918	Grether	362/188
3,539,797	11/1970	Brindley et al.	D48/24 R X

Primary Examiner—Susan J. Lucas

Attorney, Agent, or Firm—John R. Kirk, Jr.

[57]

CLAIM

The ornamental design for a hand-held spotlight, substantially as shown and described.

DESCRIPTION

FIG. 1 is a front elevational view of a hand-held spotlight showing my new design;
 FIG. 2 is a fragmentary side elevational view thereof, the cord being fragmentarily shown for convenience of illustration and the handle being fragmentarily shown for purposes of disclosure;
 FIG. 3 is a rear elevational view thereof, the cord being fragmentarily shown for convenience of illustration;
 FIG. 4 is a fragmentary cross-sectional view of the pivot on the side of the housing, the edge of the fragmentary handle also being shown;
 FIG. 5 is a side elevational view thereof on a reduced scale, the handle being shown in an alternate position;
 FIGS. 6 and 7 are top and bottom plan views, respectively, the cord being fragmentarily shown for convenience of illustration.

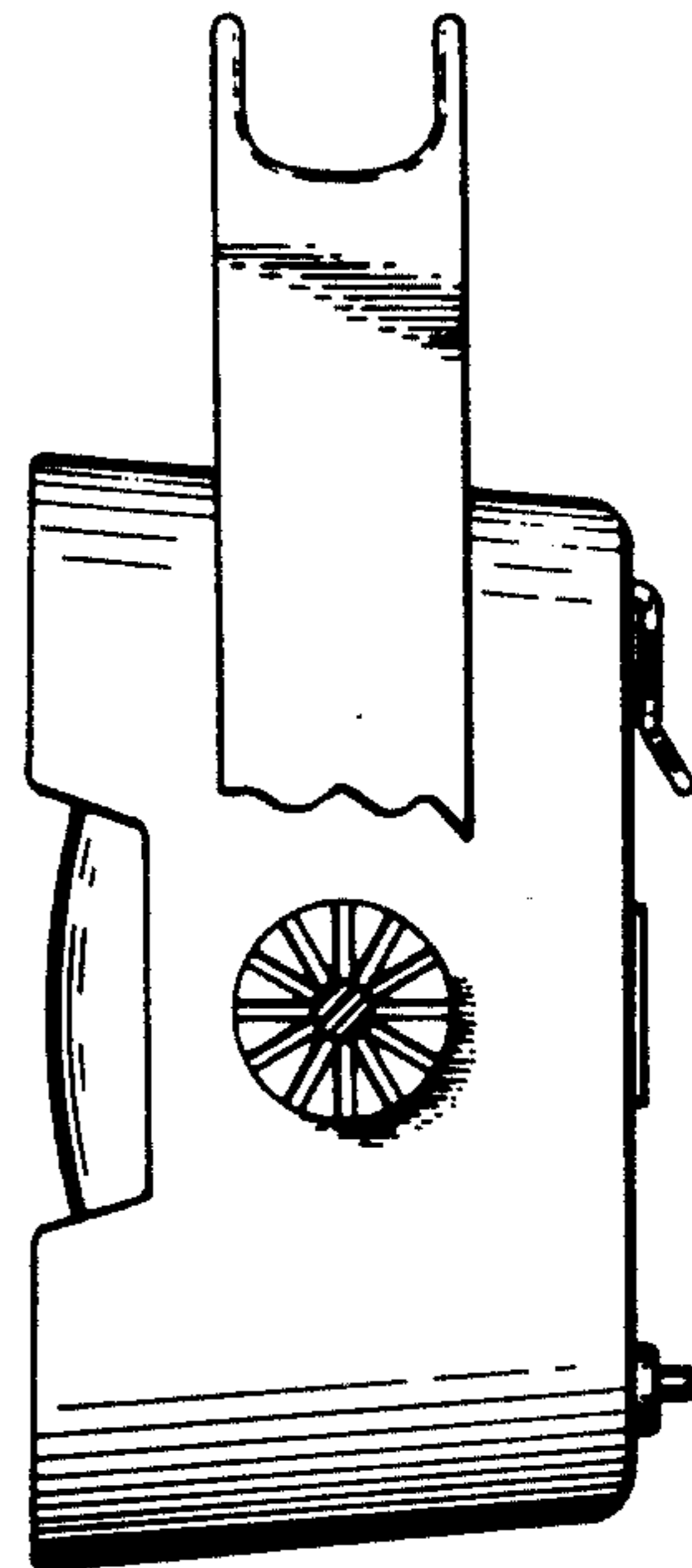
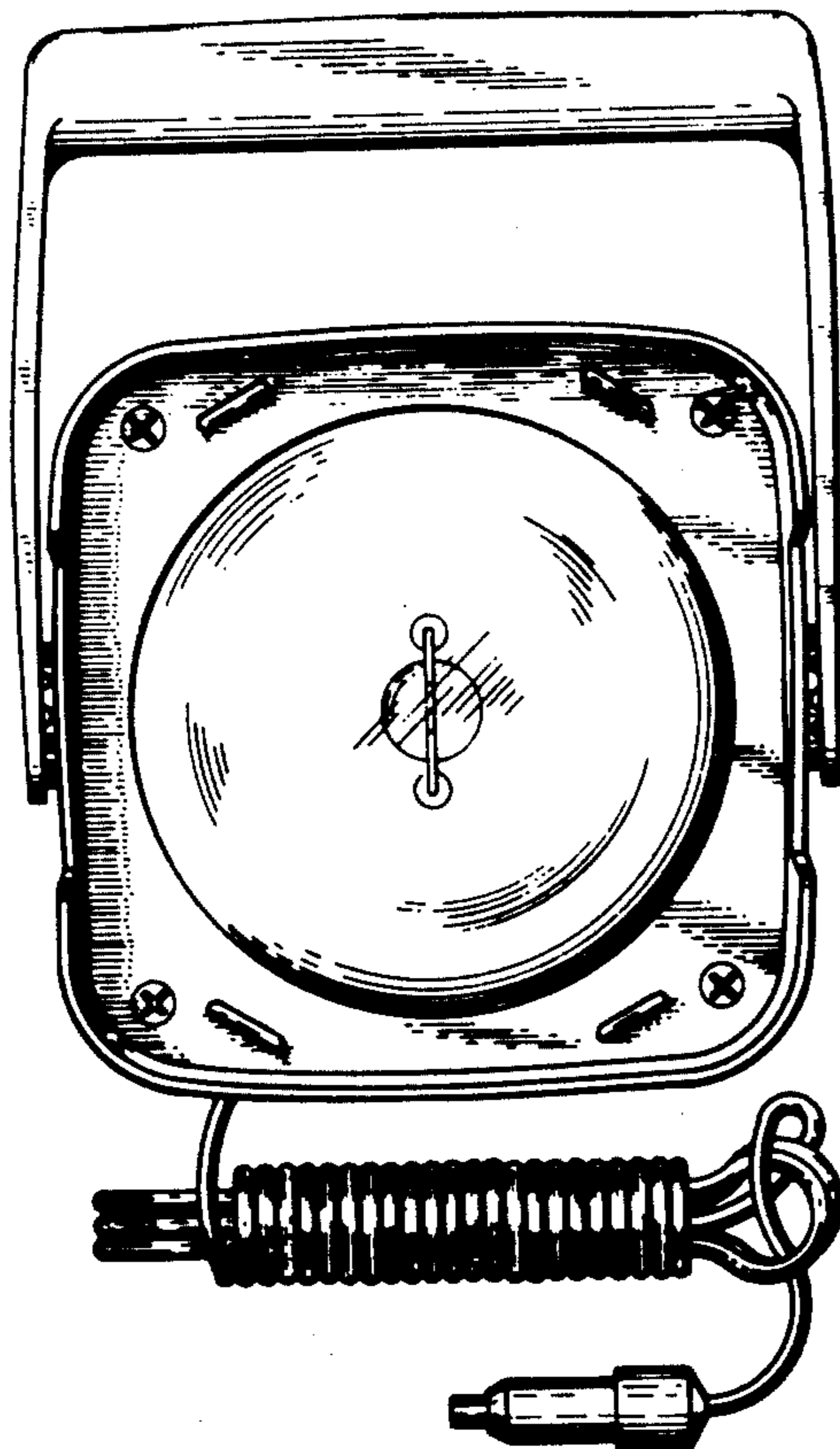

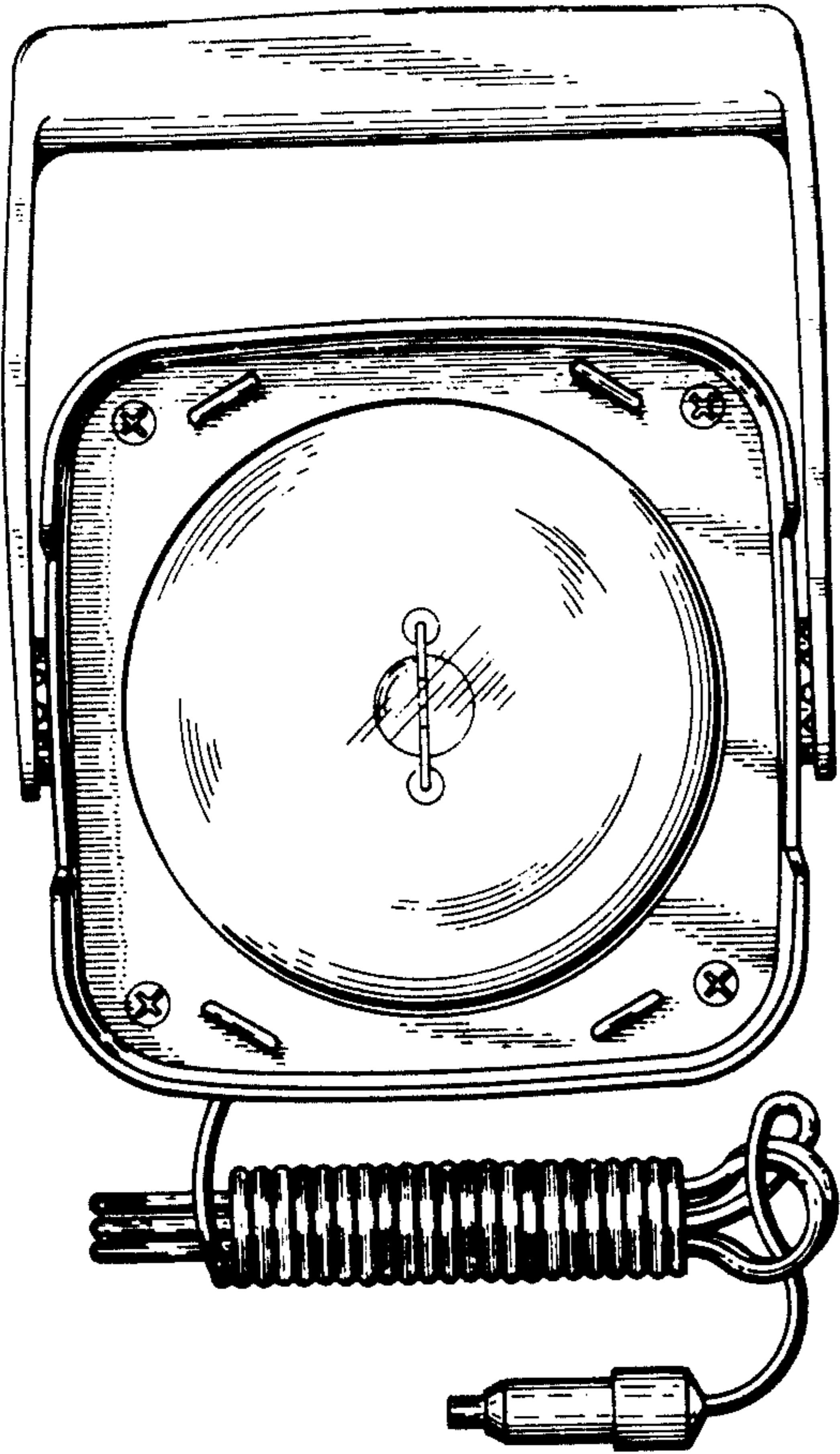

FIG. 1.

FIG. 2.

FIG. 4.

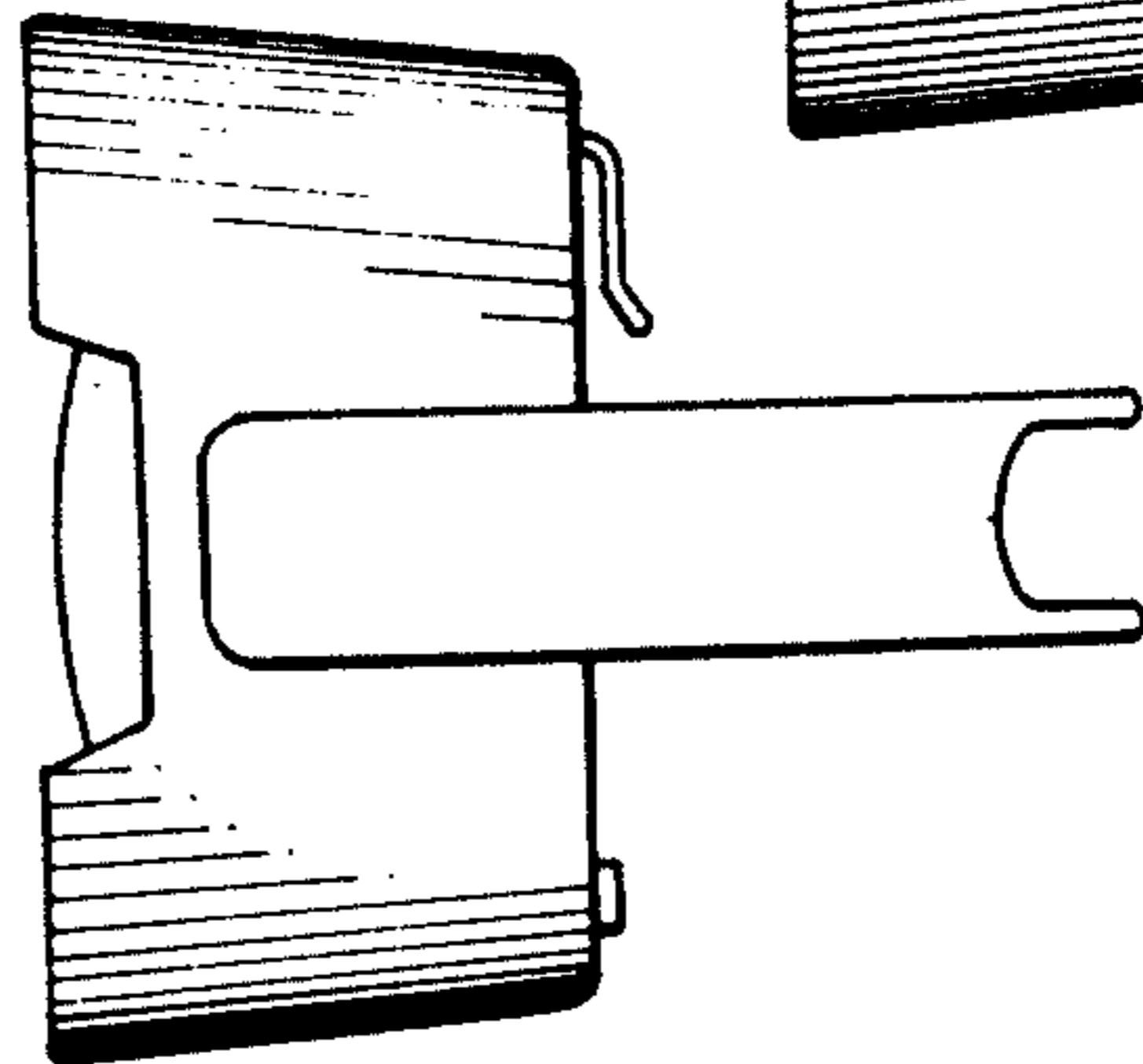
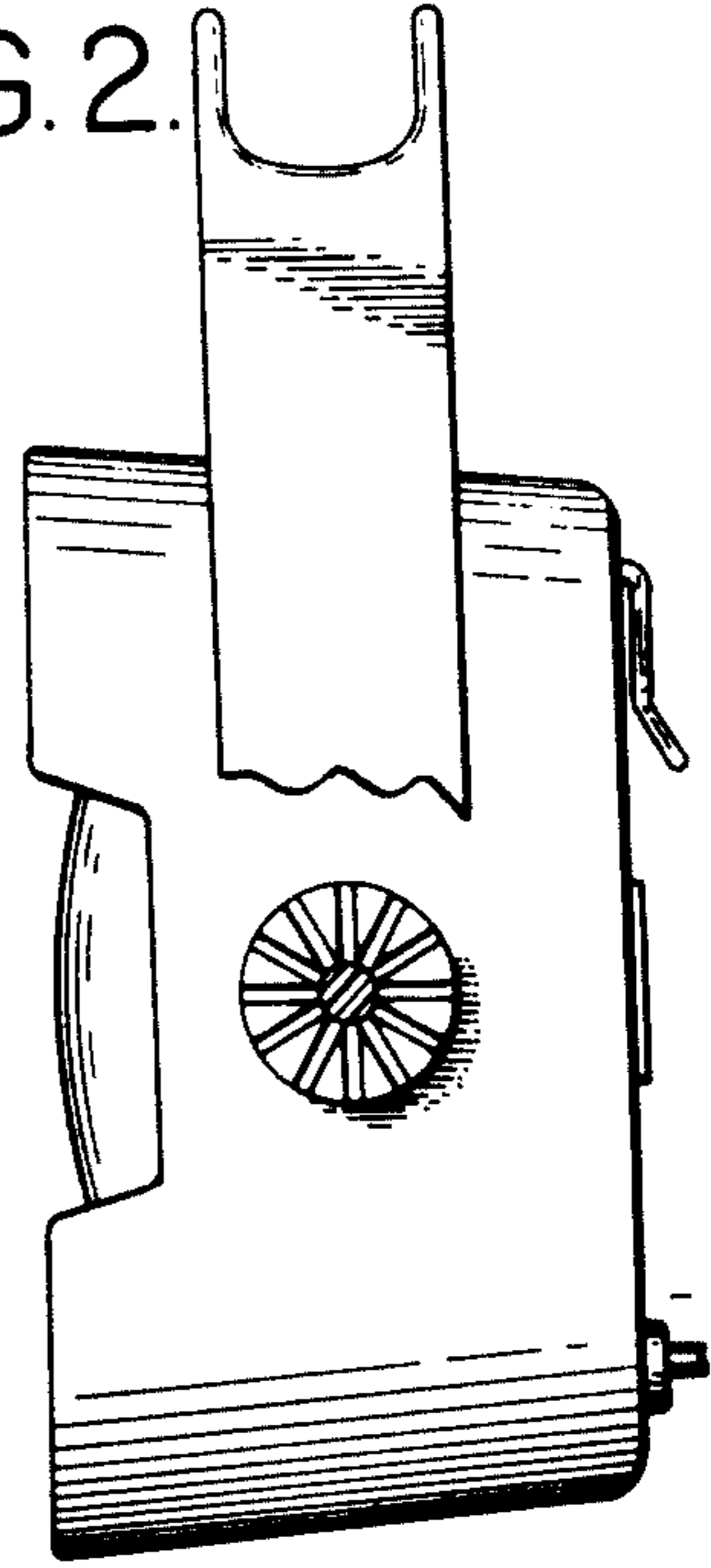
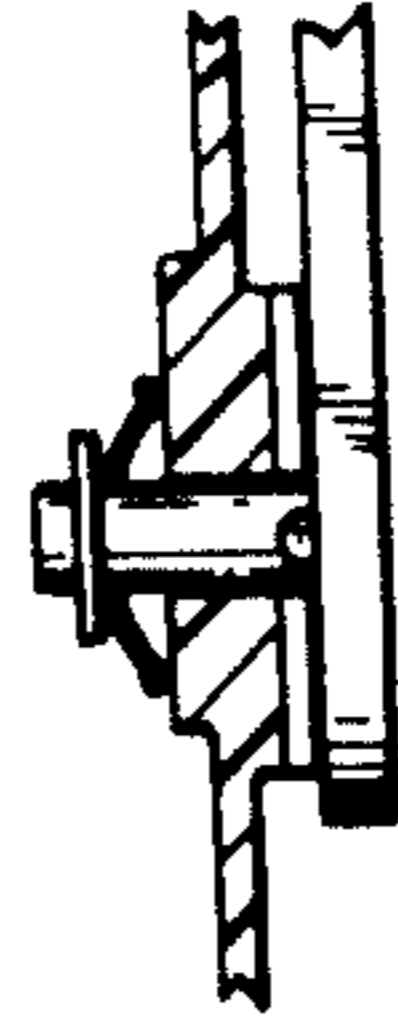

FIG. 5.

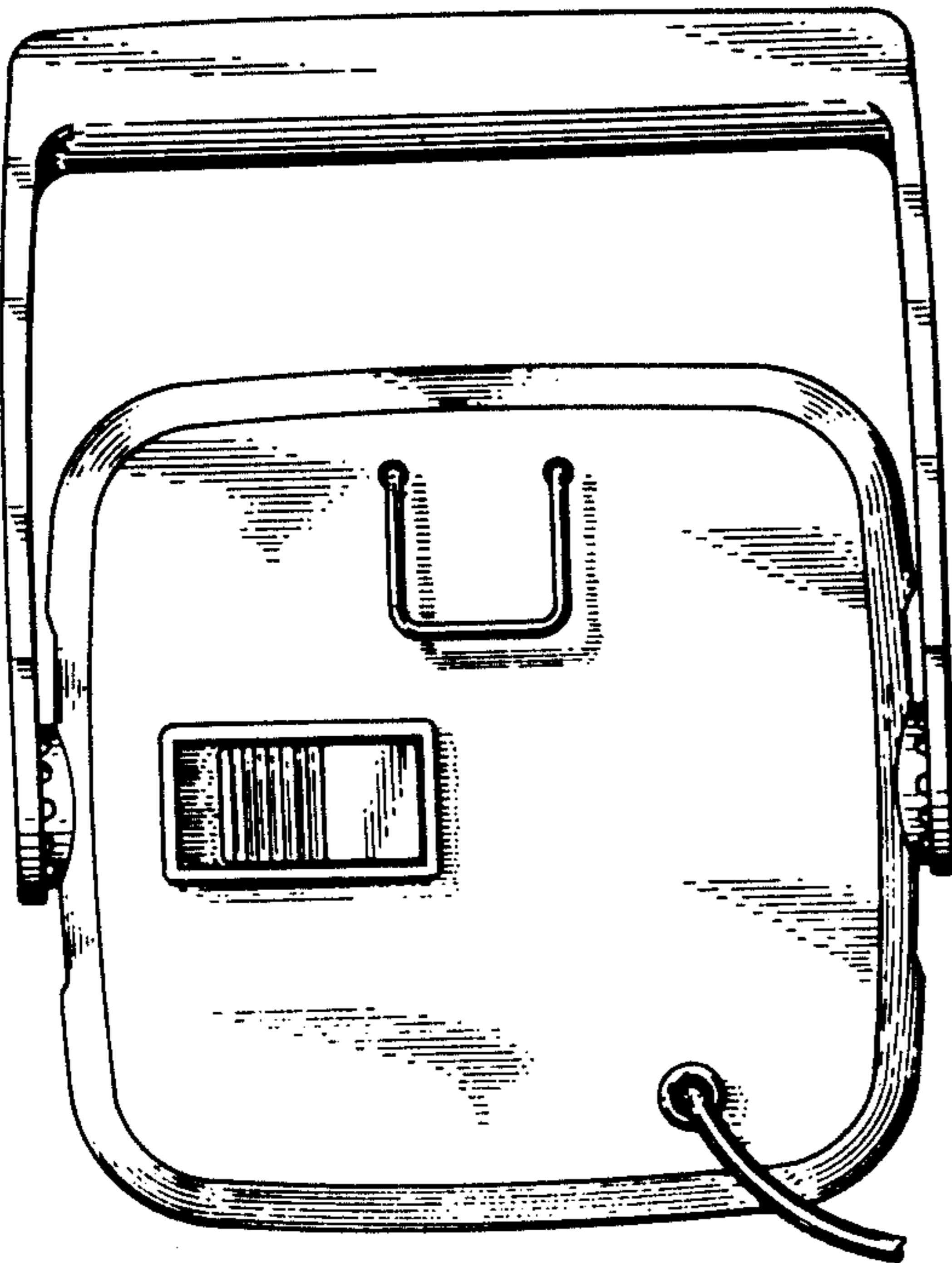

FIG. 3.

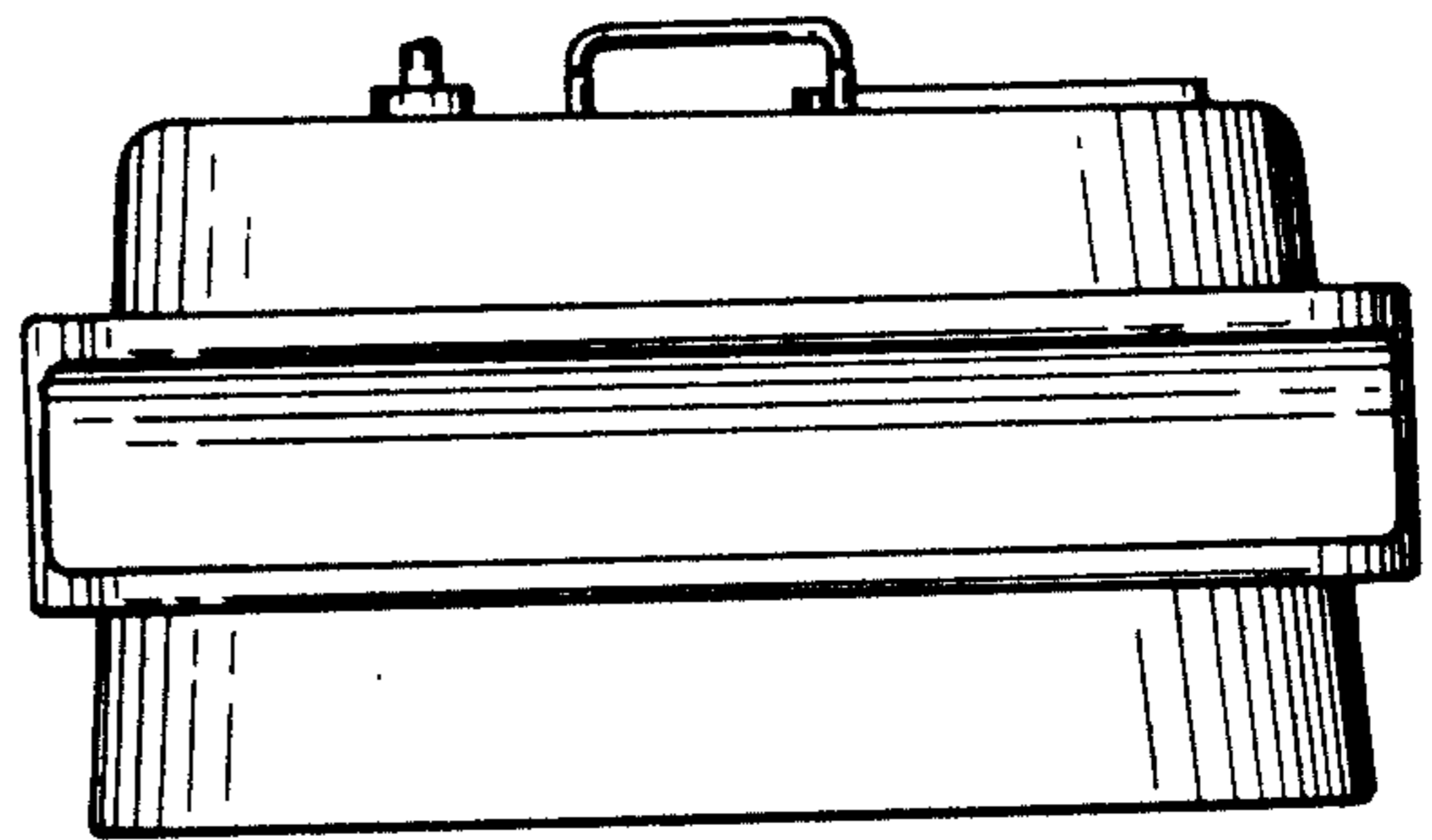

FIG. 6.

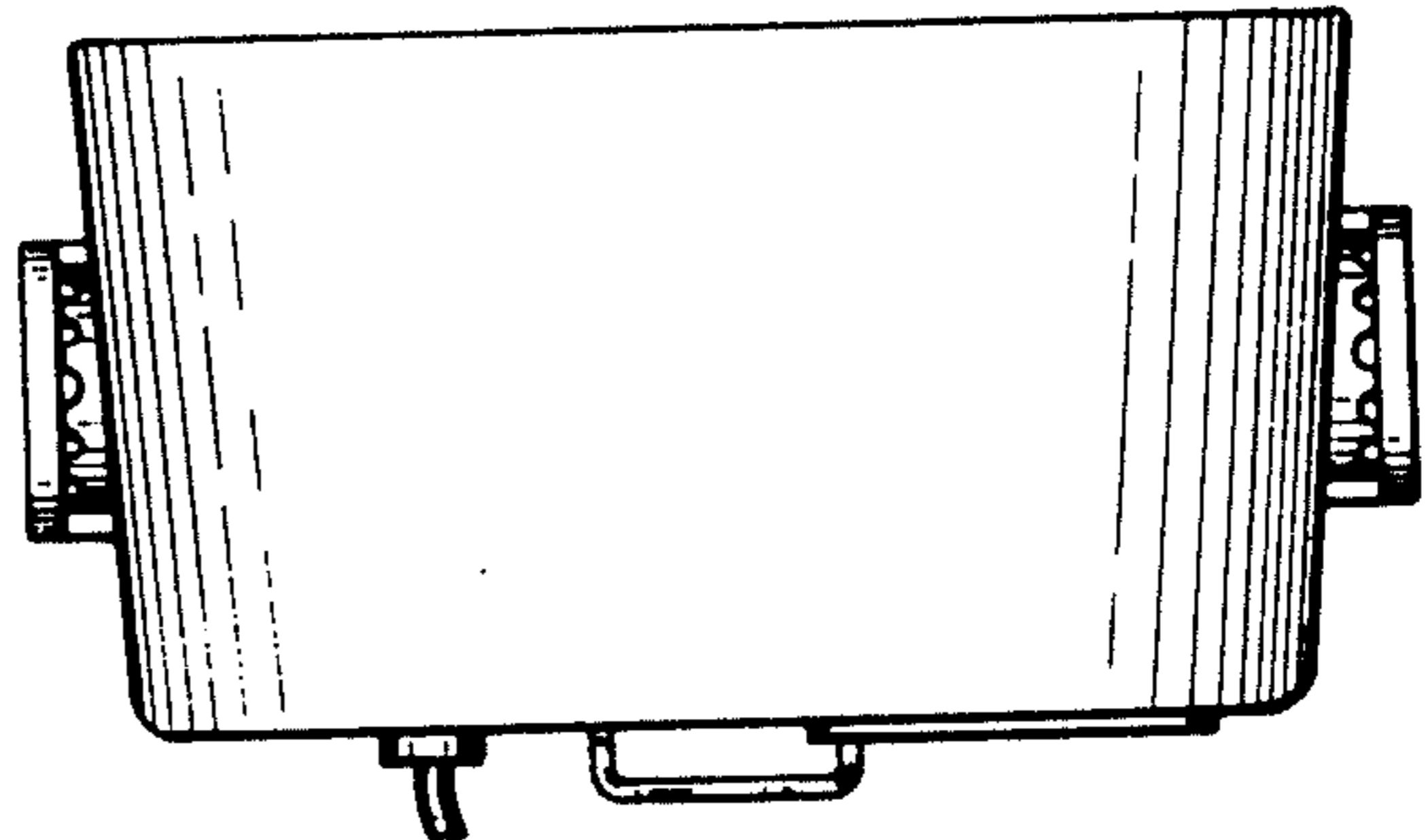

FIG. 7.