

- [54] **PORTABLE TOILET BUILDING**
- [75] **Inventors:** Frank T. Sargent; Samuel C. Crosby,  
both of Ann Arbor, Mich.
- [73] **Assignee:** Thetford Corporation, Ann Arbor,  
Mich.
- [\*\*] **Term:** 14 Years
- [21] **Appl. No.:** 834,530
- [22] **Filed:** Sep. 19, 1977
- [51] **Int. Cl.** ..... D25-03
- [52] **U.S. Cl.** ..... D22/16
- [58] **Field of Search** ..... D23/48-57,  
D23/65-68; D25/16; 4/115, 360, 3; 52/79.1,  
79.2

D. 218,156	7/1970	Johnson .....	D25/16
D. 218,157	7/1970	Johnson .....	D25/16
D. 218,929	10/1970	Johnson .....	D25/16
D. 229,828	1/1974	Hinkley .....	D25/16
3,074,076	1/1963	Kersten .....	4/115
3,629,874	12/1971	Bellar .....	4/115 X
4,031,572	6/1977	Harding .....	4/115 X

*Primary Examiner*—James R. Largen  
*Attorney, Agent, or Firm*—Finn G. Olsen

[57] **CLAIM**

The ornamental design for a portable toilet building, as shown.

**DESCRIPTION**

FIG. 1 is a perspective view of a portable toilet building showing our new design;  
FIG. 2 is a top view thereof;  
FIG. 3 is a front perspective view thereof, with the door in an open position;  
FIG. 4 is a front elevational view thereof;  
FIG. 5 is a rear elevational view thereof;  
FIG. 6 is a left side elevational view thereof; and  
FIG. 7 is a right elevational view thereof.

- [56] **References Cited**
- U.S. PATENT DOCUMENTS**
- D. 192,112 1/1962 Kulka ..... D25/16
- D. 209,192 11/1967 Harding ..... D25/16
- D. 210,008 1/1968 Thompson ..... D25/16
- D. 214,886 8/1969 Katona ..... D25/16

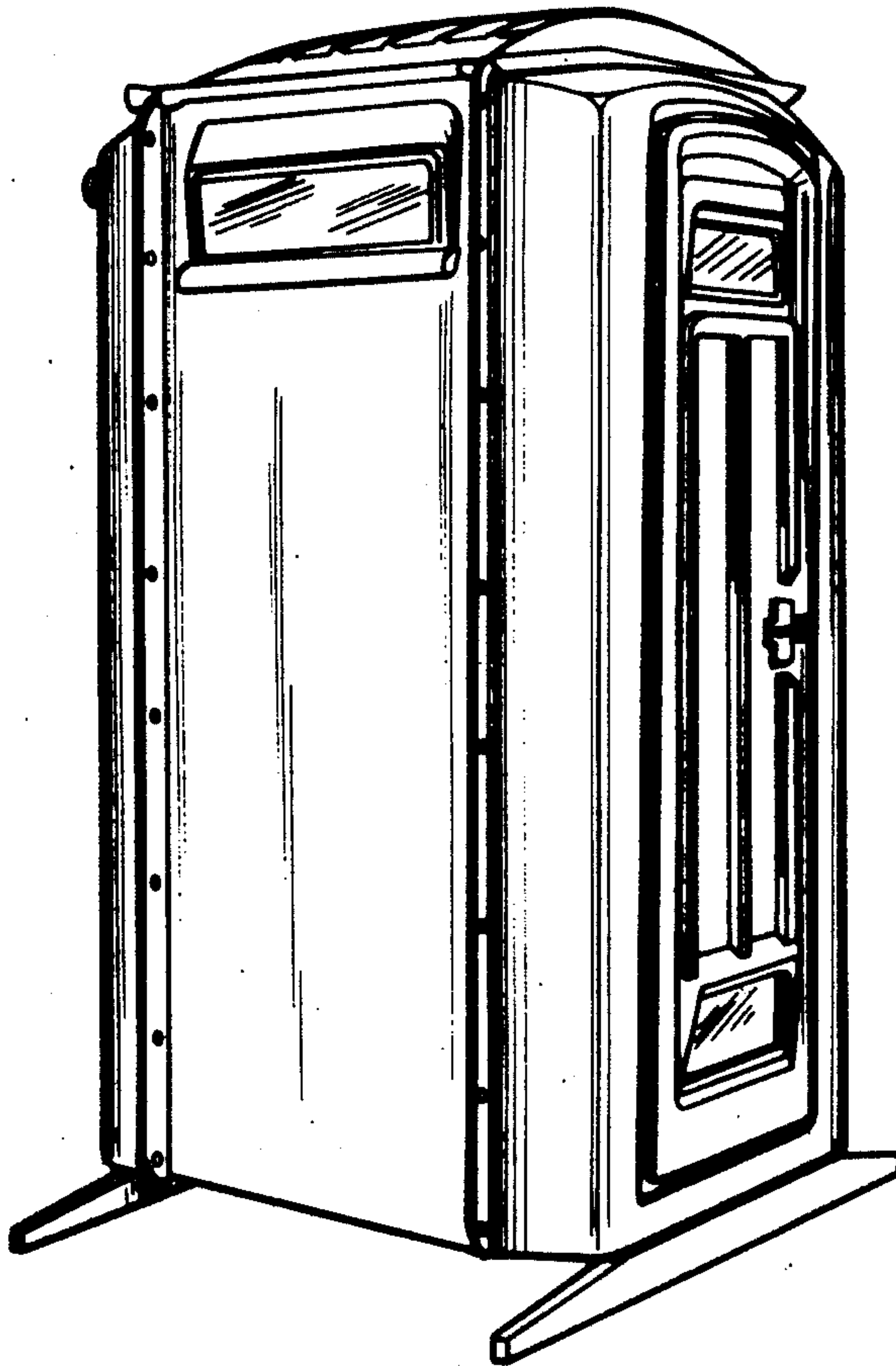

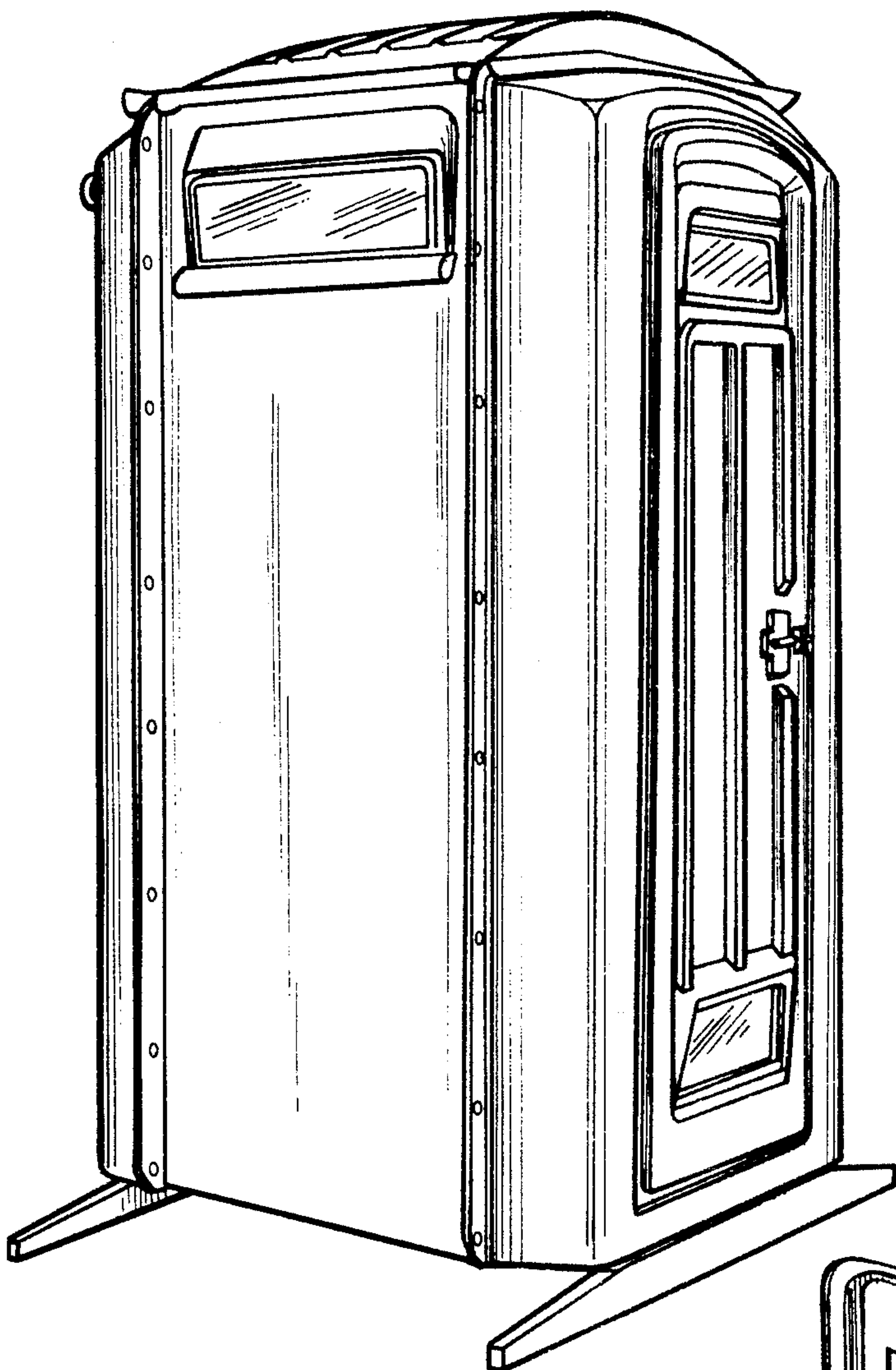

Fig-1

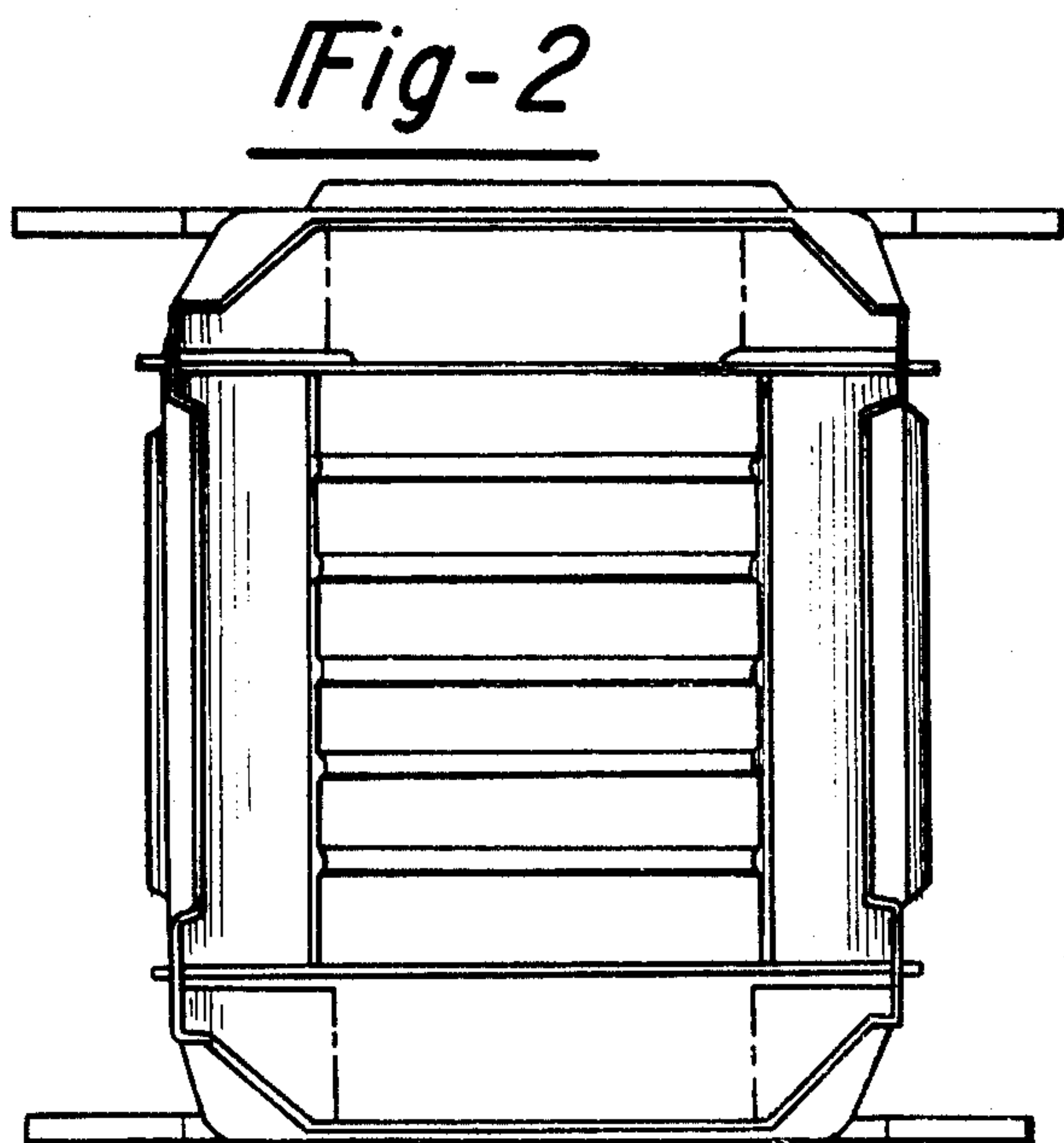

Fig-2

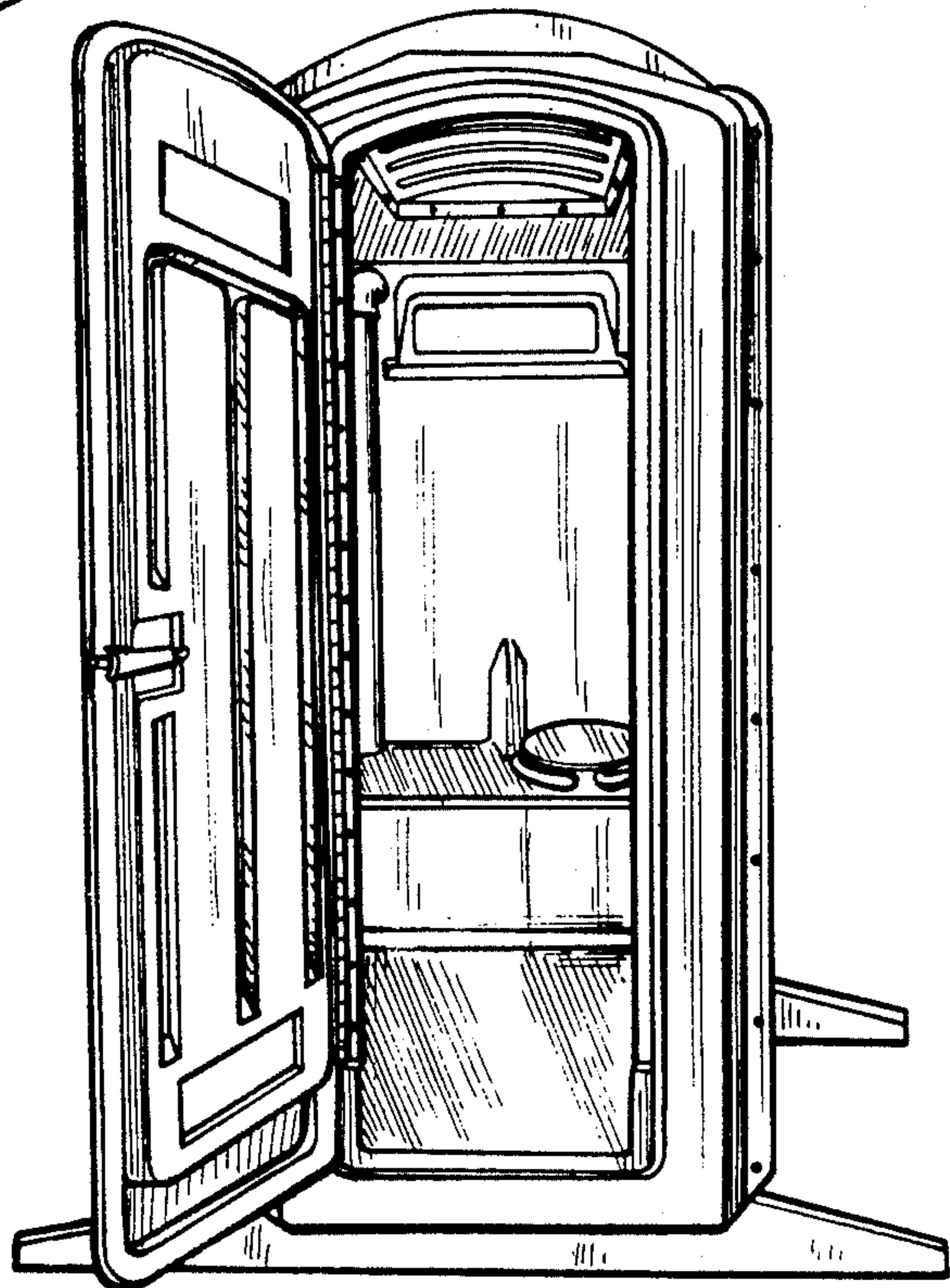

Fig-3

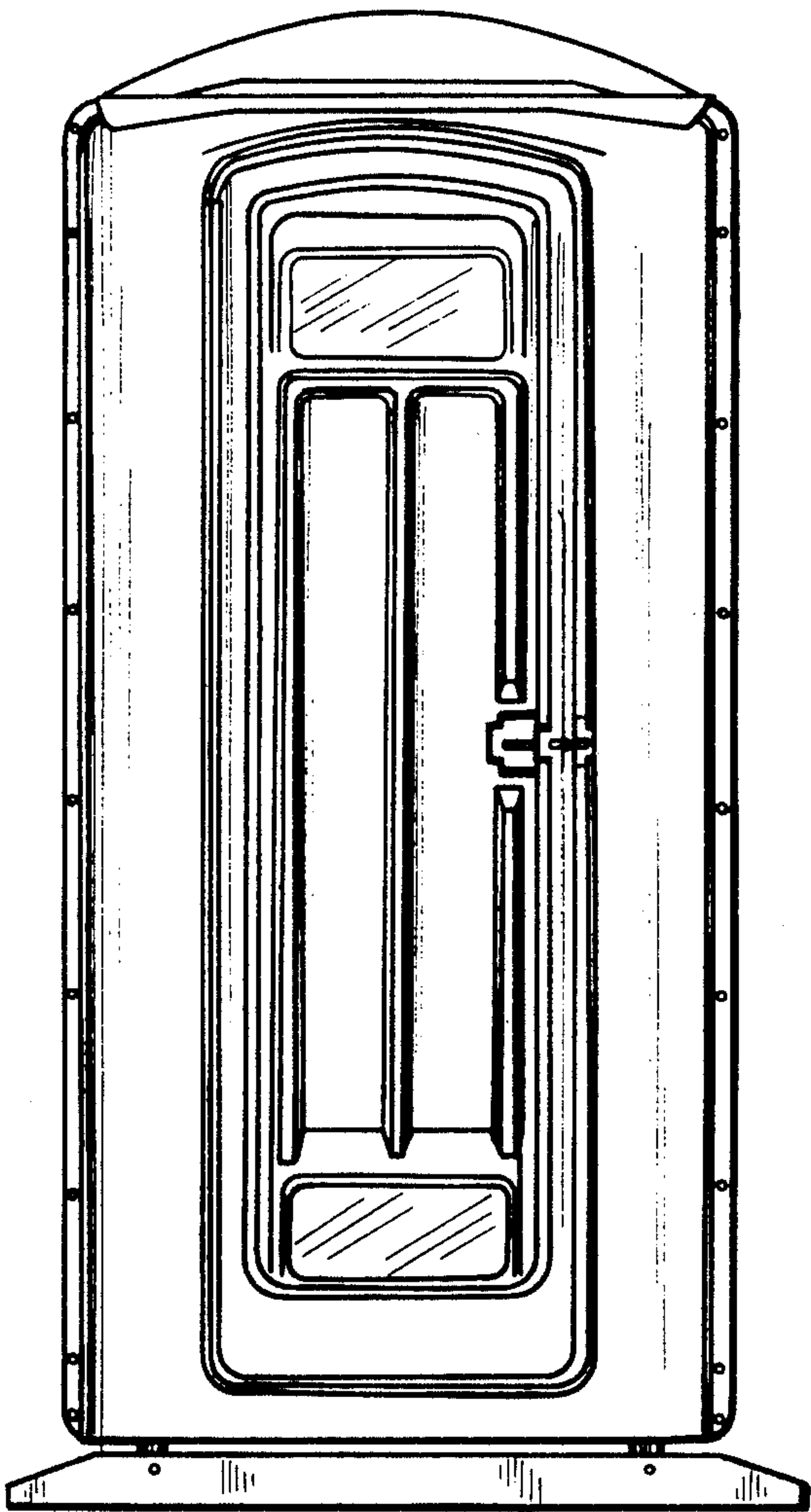

Fig-4

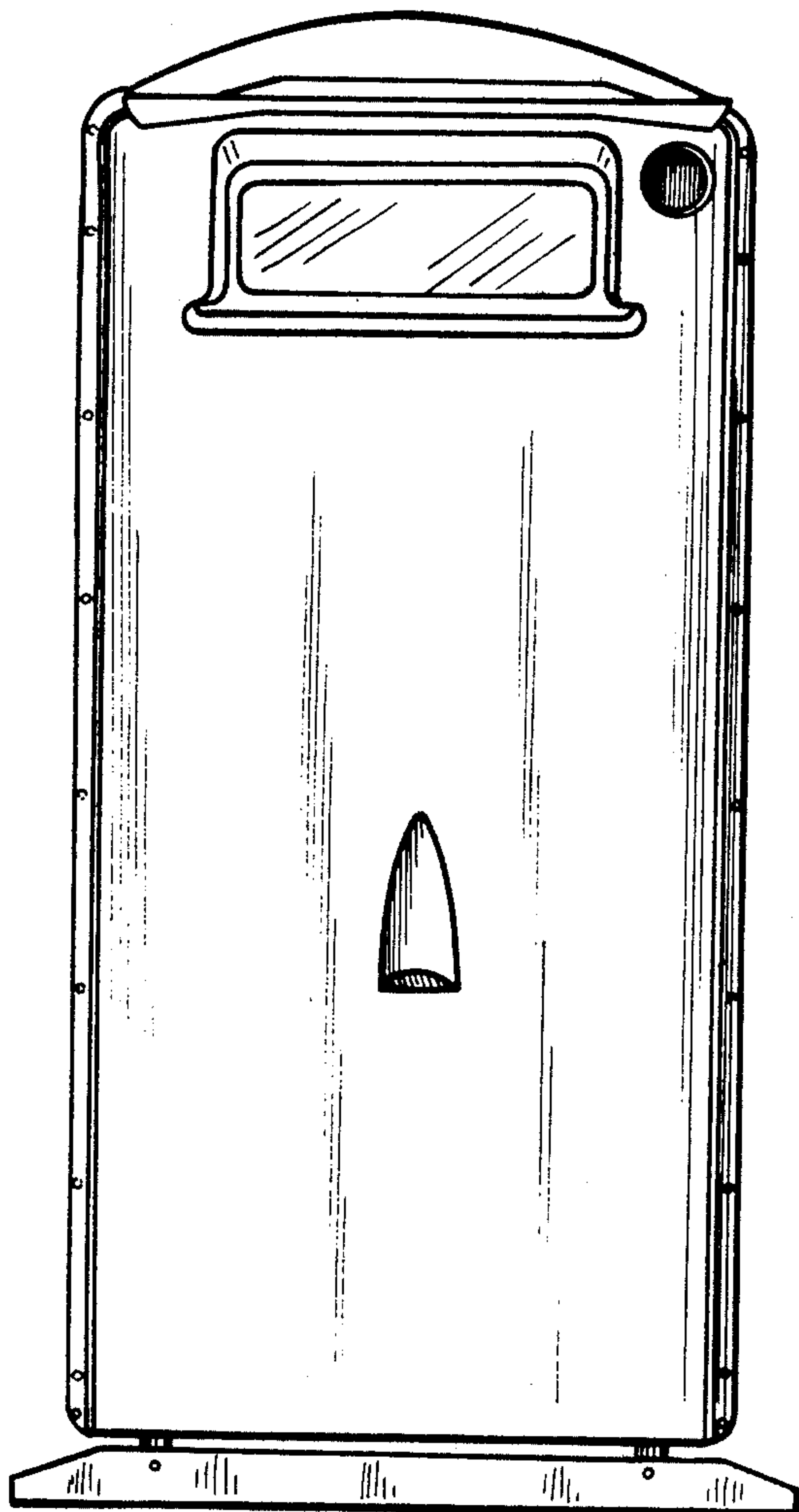

Fig-5



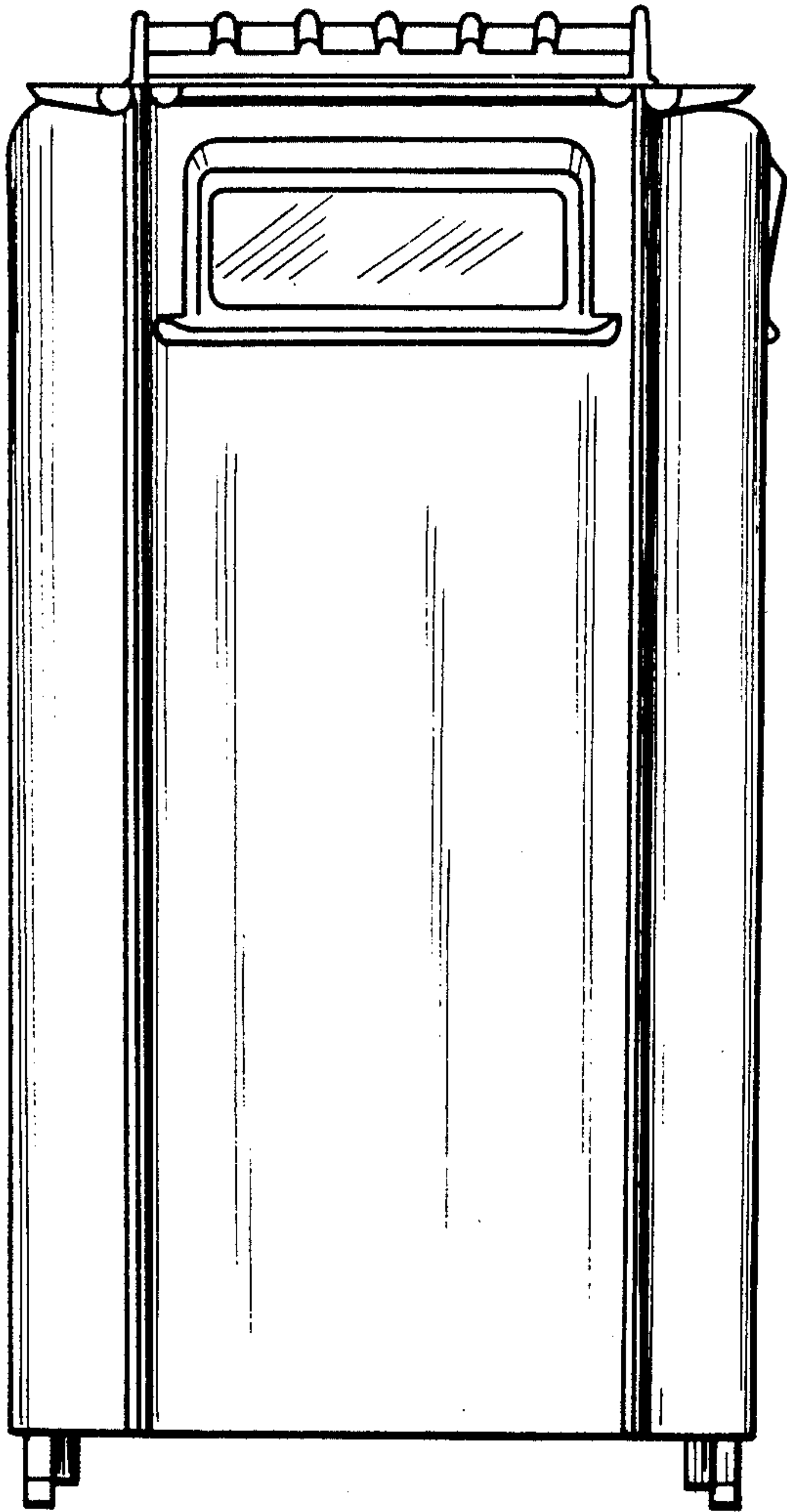

Fig-7

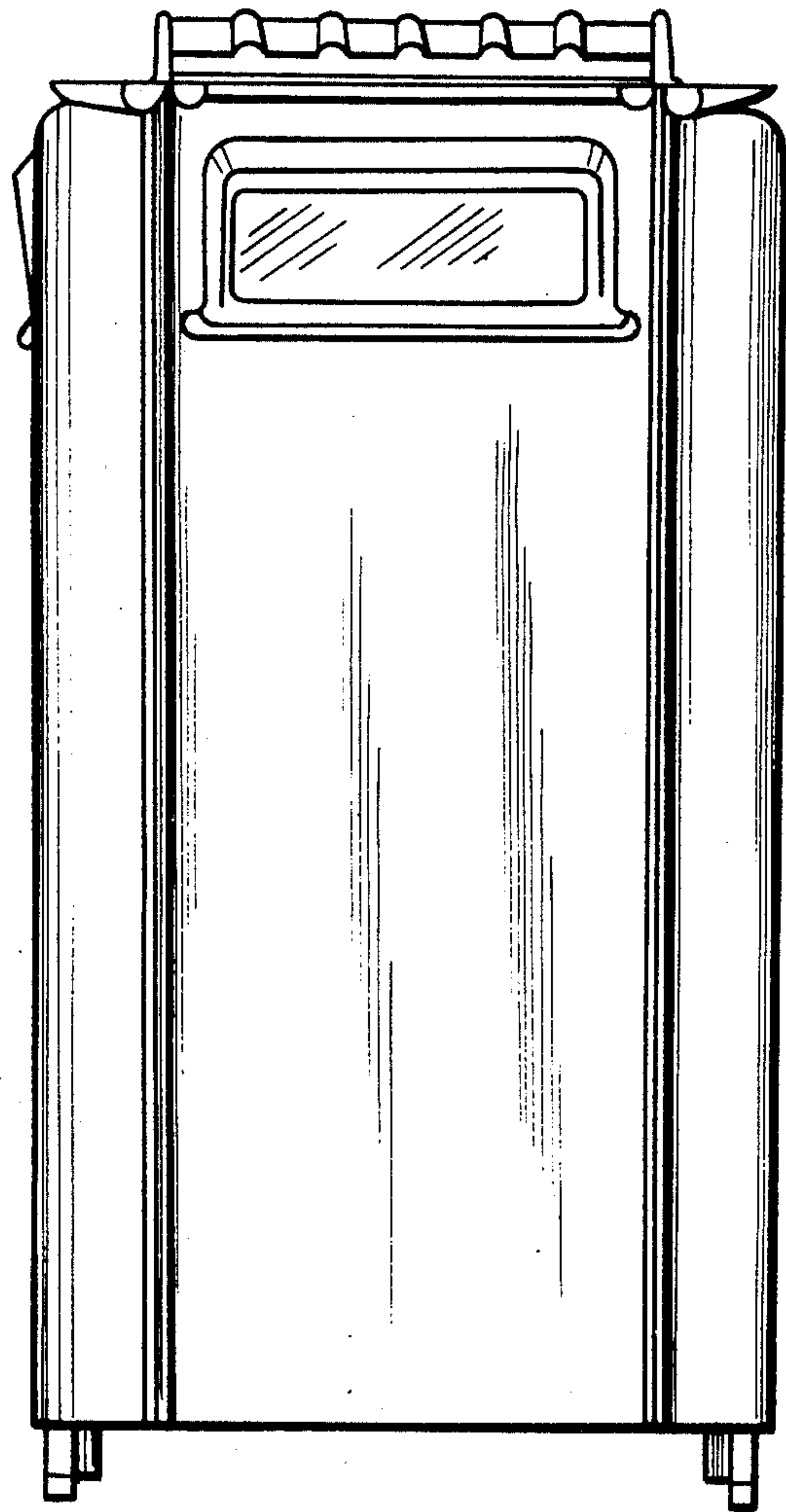

Fig-6