

[54] BREAD-OVEN

[76] Inventor: Guy Selva, 7 Rue Vendome, Lyon, France, 69006

[**] Term: 14 Years

[21] Appl. No.: 685,010

[22] Filed: May 10, 1976

[51] Int. Cl. D7-02

[52] U.S. Cl. D15/108; D7/126

[58] Field of Search D7/111-120, D7/126; D15/92, 104, 106, 108-110; 126/1 R, 4, 15 R, 19 R, 273 R; 99/325, 467, 468, 473, 324, 340, 341, 348

[56] References Cited

U.S. PATENT DOCUMENTS

D. 28,601	5/1898	McMillan	D7/126
D. 173,983	2/1955	Janssen	D7/126 X
D. 223,065	3/1972	Turner	D15/108

662,175	11/1900	Starks	126/273 R
2,134,474	10/1938	Gillespie	126/273 R

Primary Examiner—Wallace R. Burke
Assistant Examiner—Catherine Kemper
Attorney, Agent, or Firm—Arthur E. Dowell, III

[57] CLAIM

The ornamental design for a bread-oven, as shown.

DESCRIPTION

FIG. 1 is a top plan view of a bread oven, showing my new design;
FIG. 2 is a front elevational view thereof;
FIG. 3 is a left side elevational view thereof;
FIG. 4 is a right side elevational view thereof;
FIG. 5 is a rear elevational view thereof;
FIG. 6 is a bottom plan view thereof;
FIG. 7 is a perspective view looking at the front and left-side thereof.
FIG. 8 is a perspective view looking at the rear and left-side thereof.

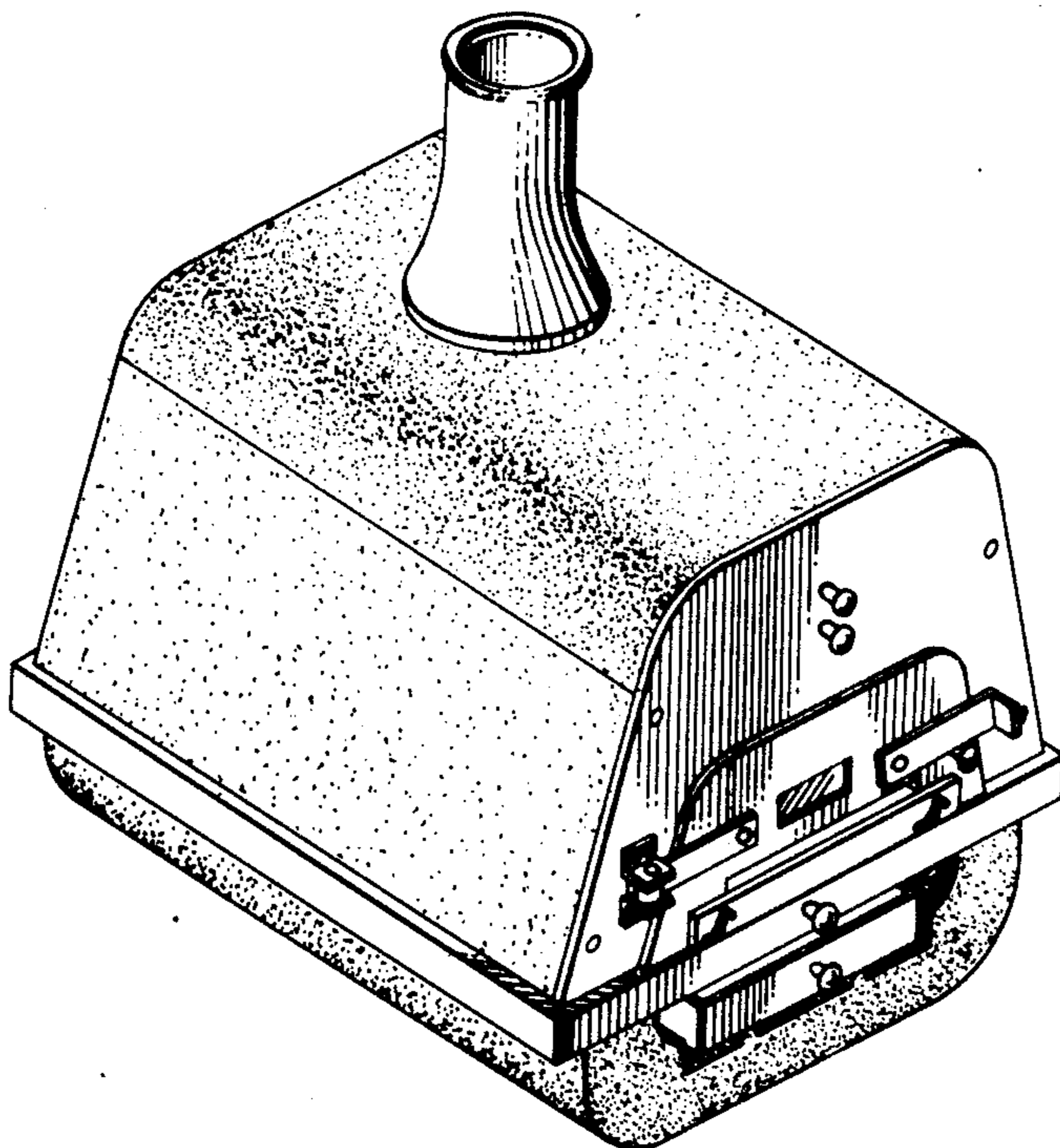

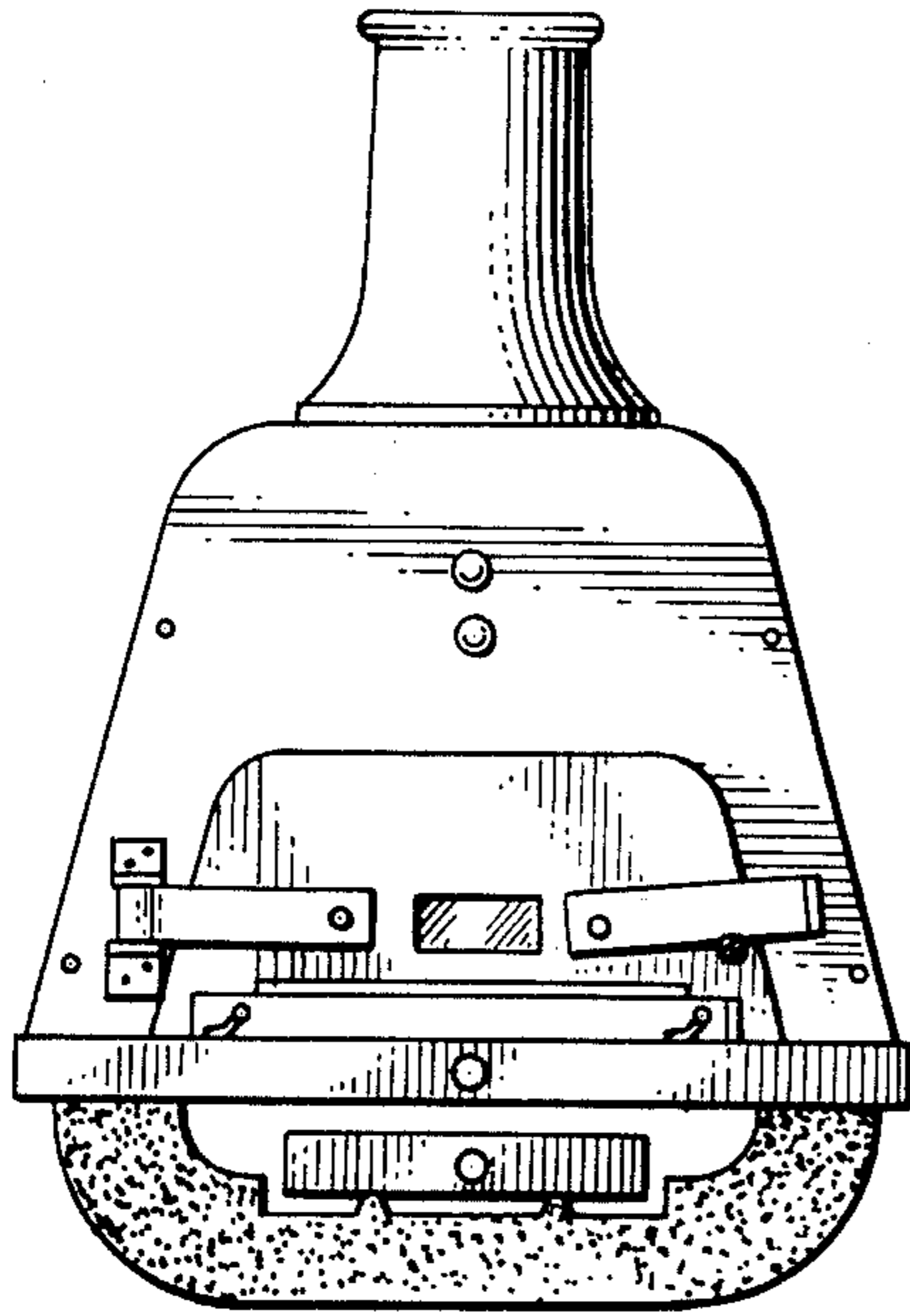

FIG. 2.

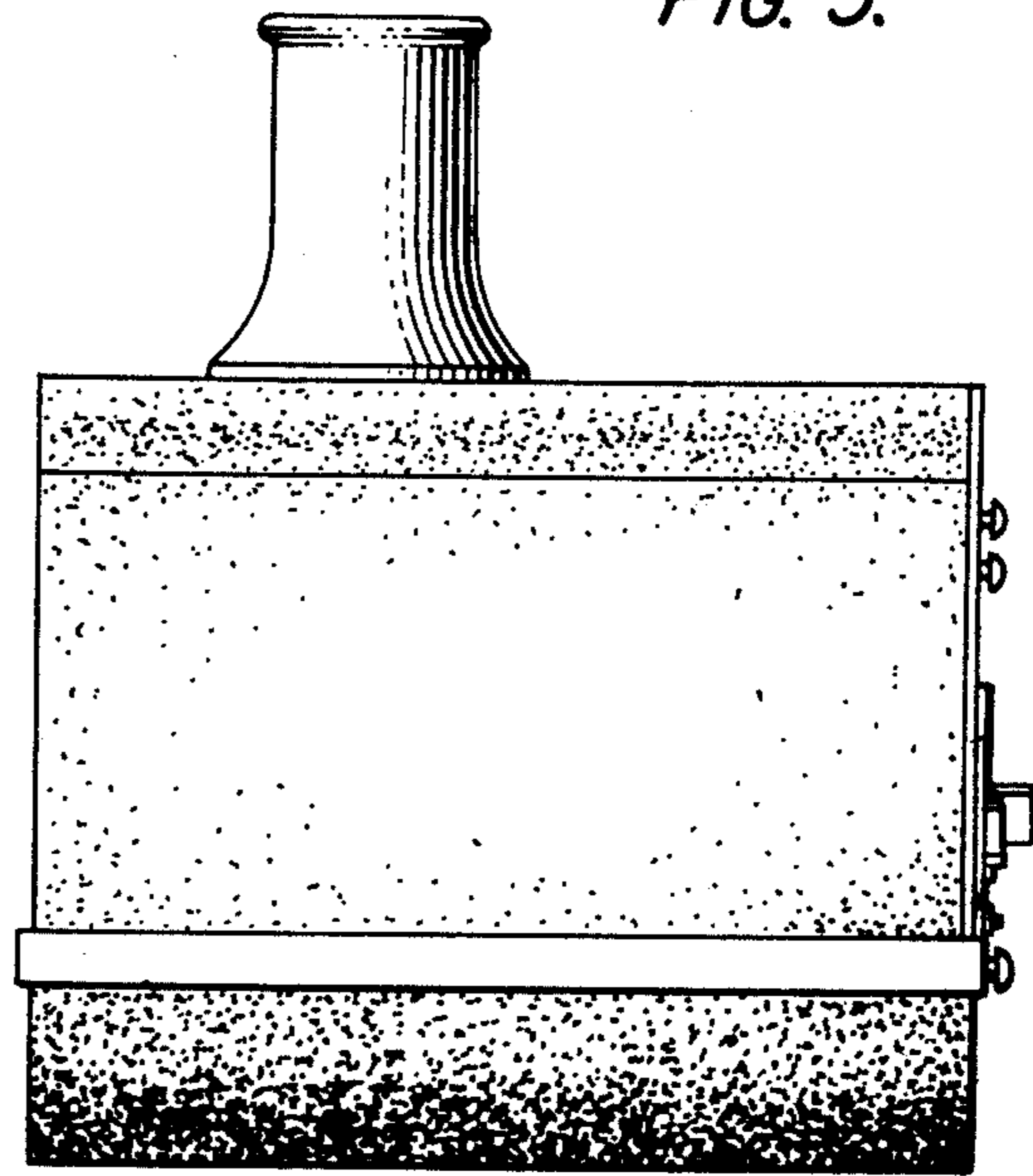

FIG. 3.

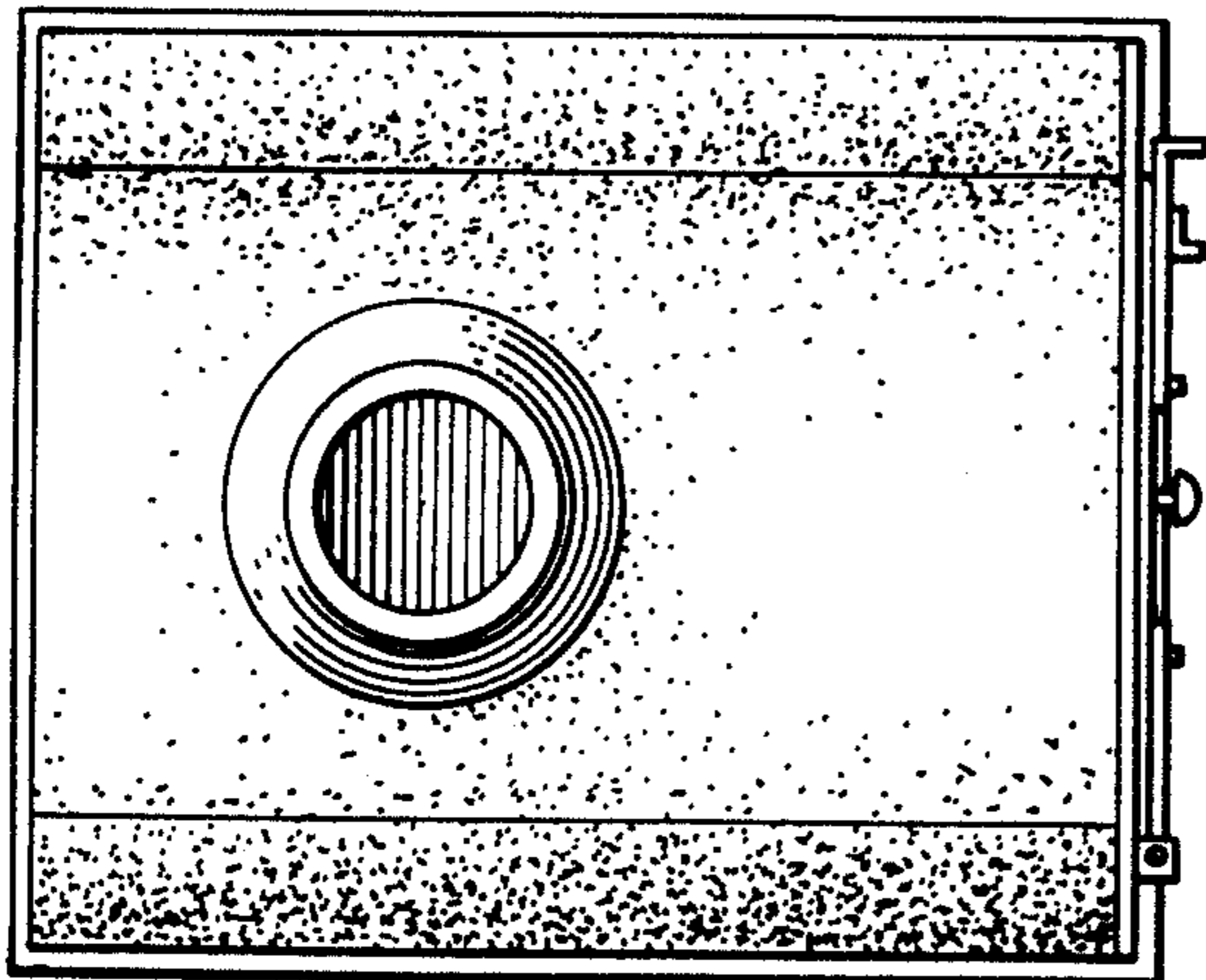

FIG. 1.

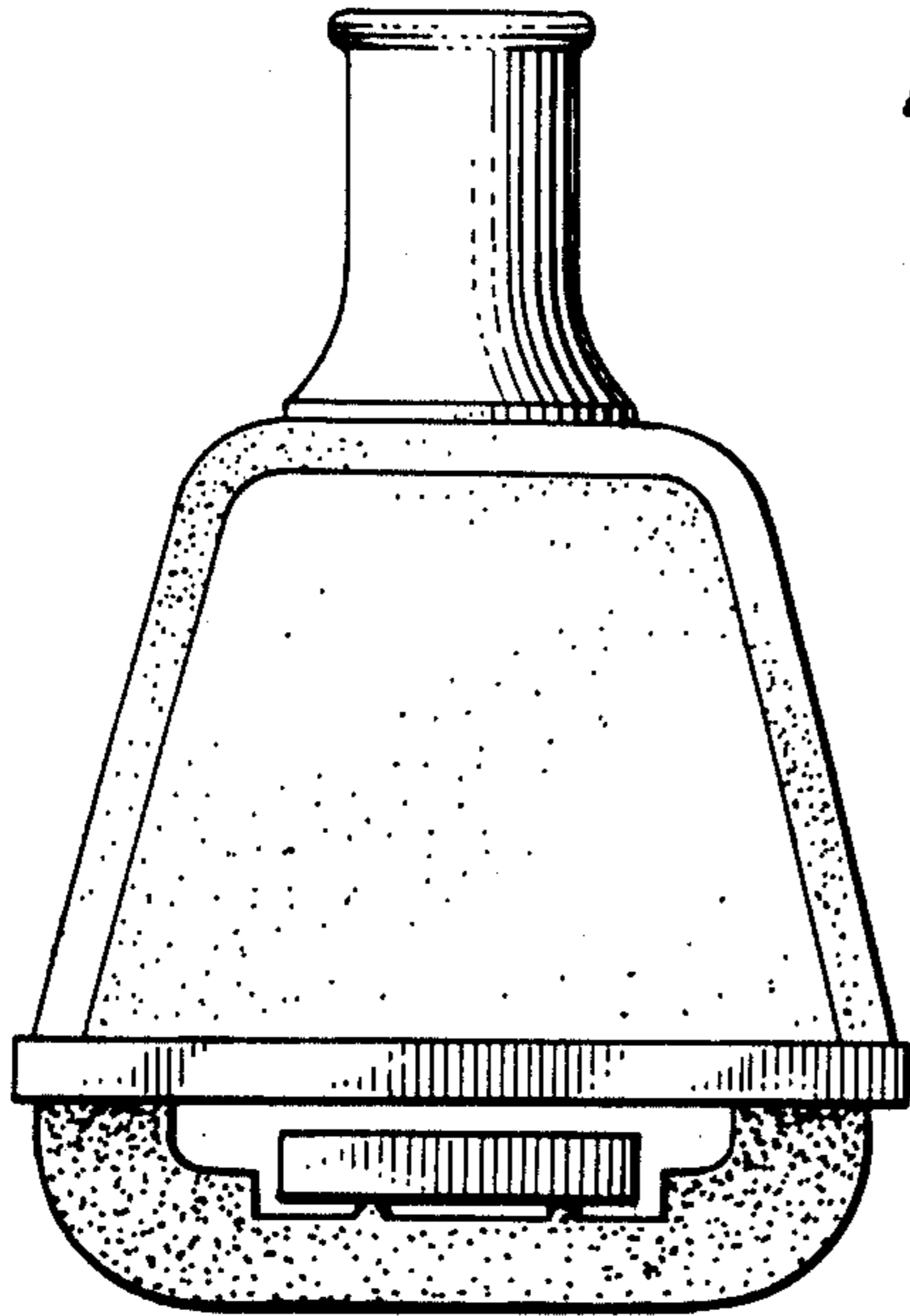

FIG. 5.

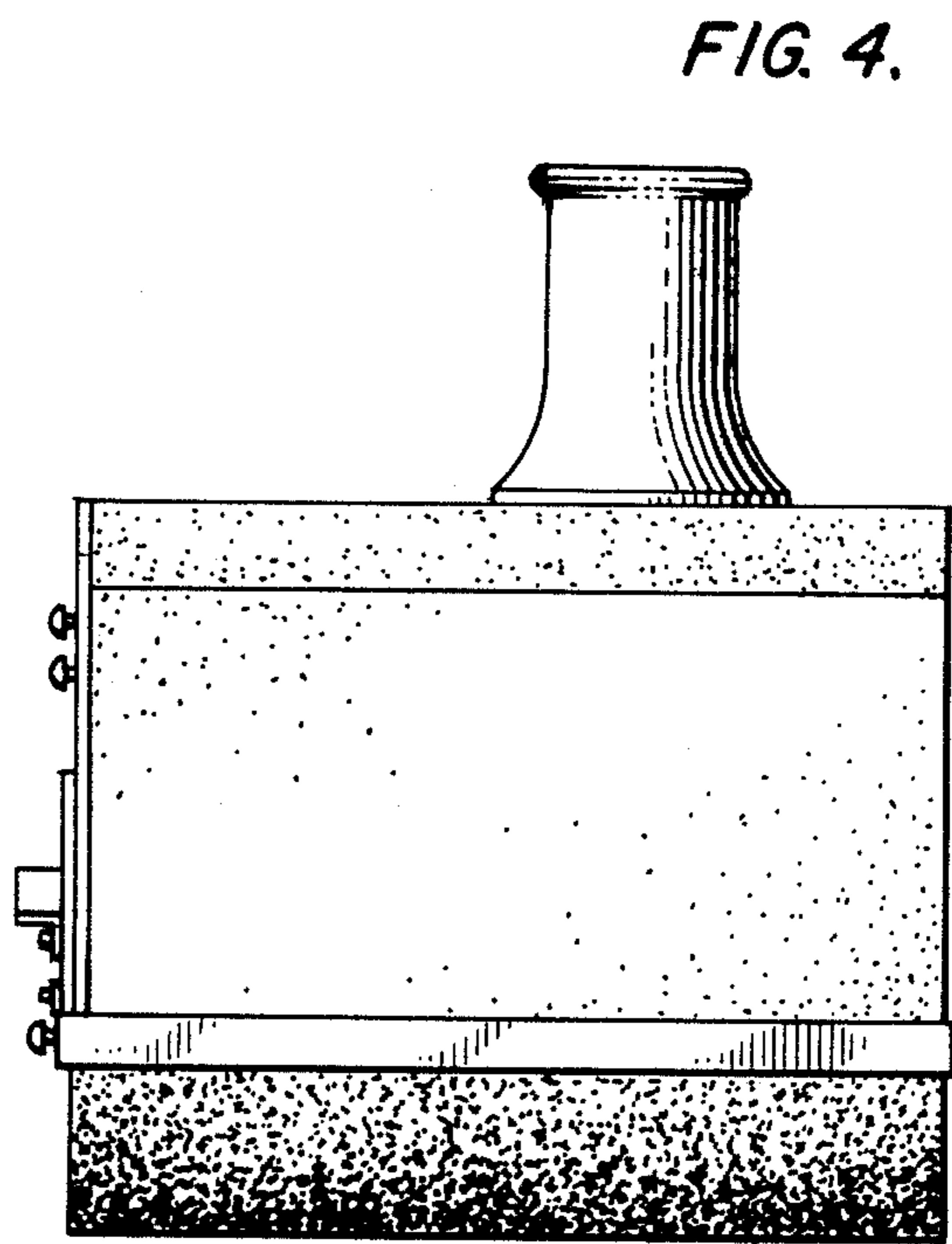
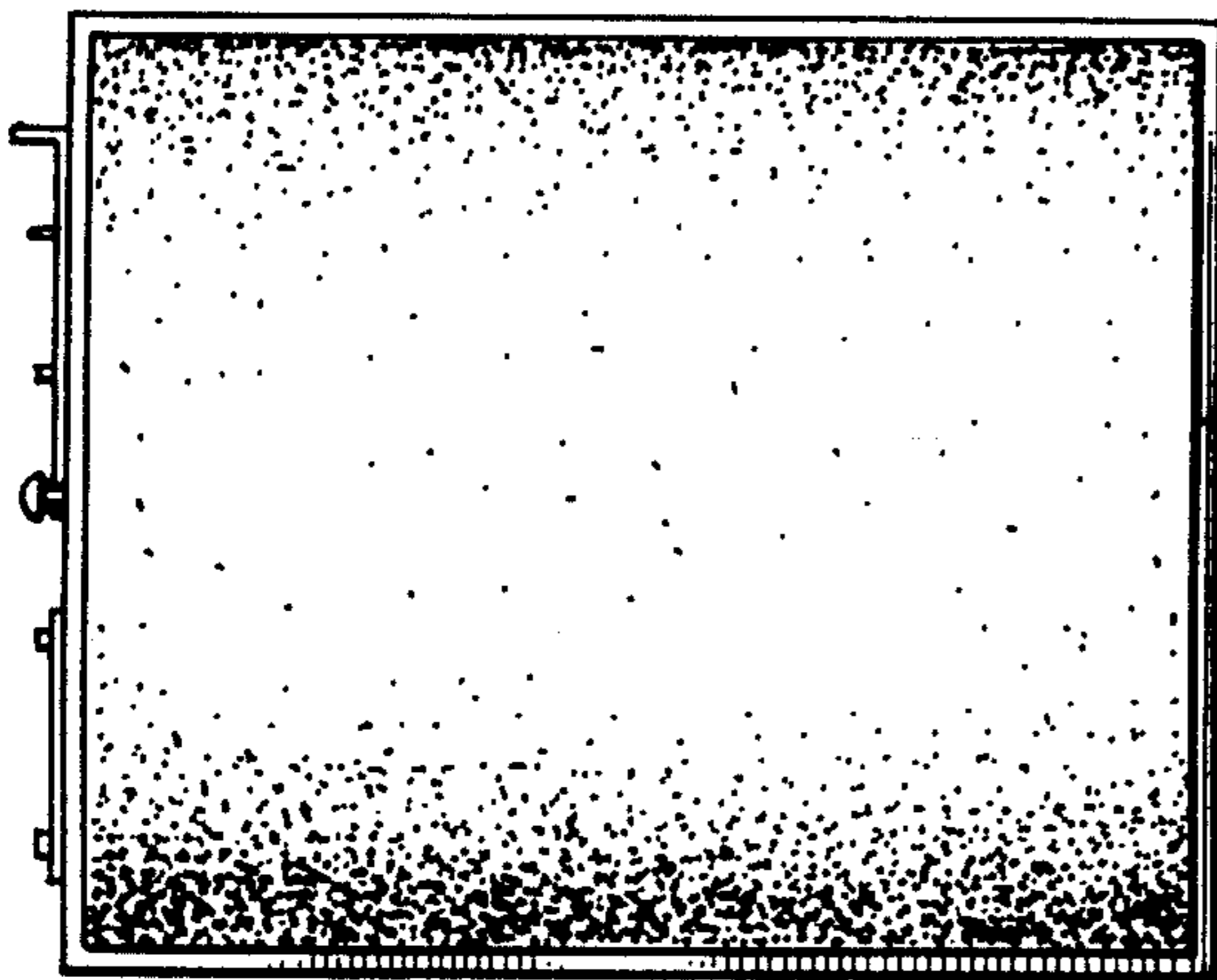

FIG. 4.

FIG. 6.



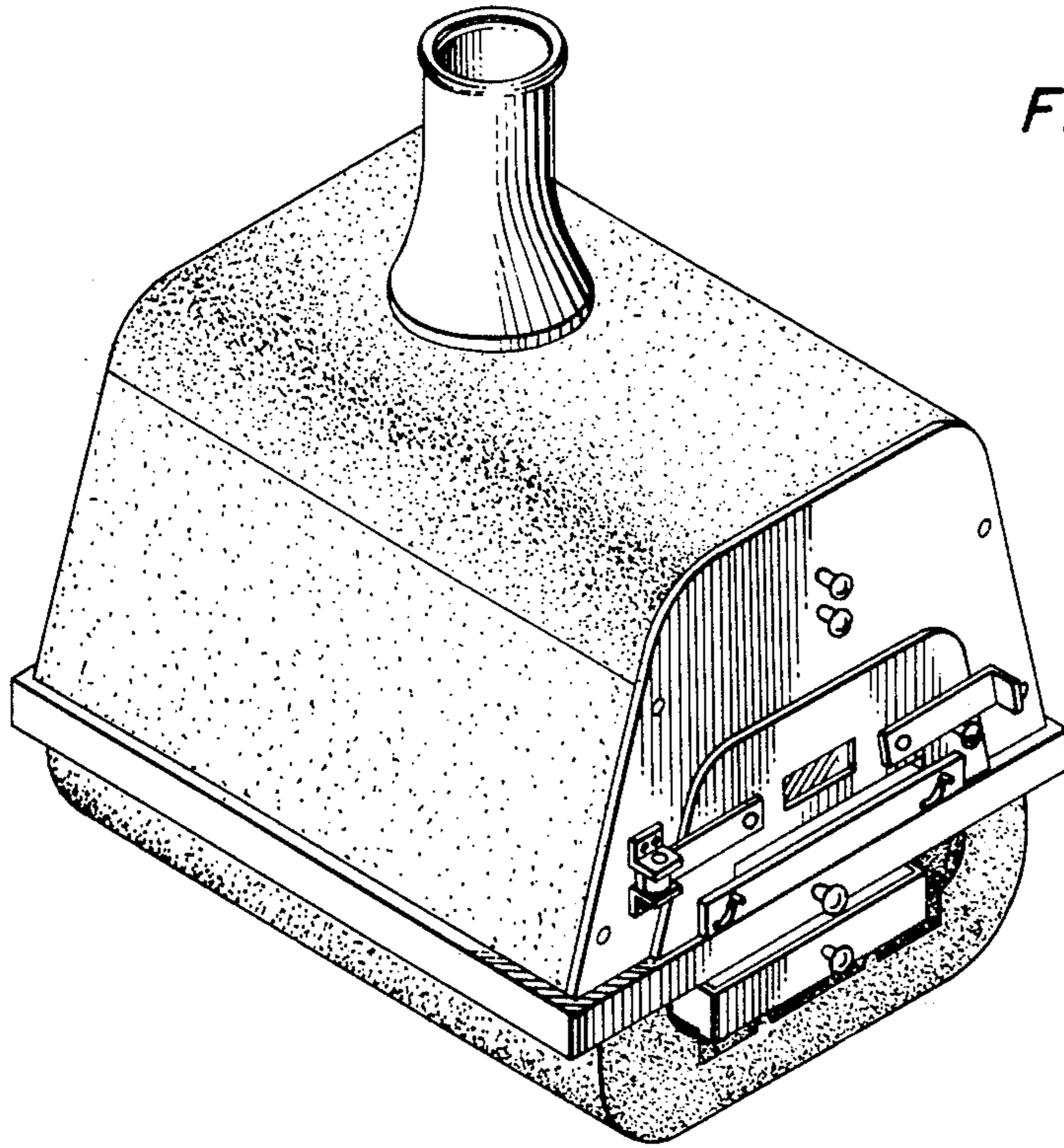

FIG. 7.

FIG. 8.

