

[54] COMBINED CARRYING CASE AND COVER FOR A SEWING MACHINE

[76] Inventor: Cristian J. Felix, 43-32 170th St., Flushing, N.Y. 11358

[**] Term: 14 Years

[21] Appl. No.: 781,900

[22] Filed: Mar. 28, 1977

[51] Int. Cl. D3-02

[52] U.S. Cl. D87/1 R

[58] Field of Search D87/1 R, 5 F; 150/52 R; 312/208

[56] References Cited

U.S. PATENT DOCUMENTS

D. 153,660	5/1949	Arbib	D87/5 F
D. 225,091	11/1972	Peets	D87/1 R
D. 229,365	11/1973	Genaro	D87/1 R
D. 229,727	12/1973	Genaro	D87/1 R

Primary Examiner—Joel Stearman
Assistant Examiner—George P. Word

Attorney, Agent, or Firm—Robert E. Smith

[57] CLAIM

The ornamental design for a combined carrying case and cover for a sewing machine, as shown and described.

DESCRIPTION

FIG. 1 is a perspective view of a combined carrying case and cover for a sewing machine showing my new design;
FIG. 2 is a right end elevational view;
FIG. 3 is a rear elevational view;
FIG. 4 is a top plan view;
FIG. 5 is a left end elevational view;
FIG. 6 is a front elevational view;
FIG. 7 is a bottom plan view;
FIG. 8 is a left end elevational view of the cover portion of the carrying case;
FIG. 9 is a front elevational view thereof;
FIG. 10 is a right end elevational view thereof;
FIG. 11 is a rear elevational view thereof;
FIG. 12 is a top plan view thereof; and
FIG. 13 is a bottom plan view thereof.

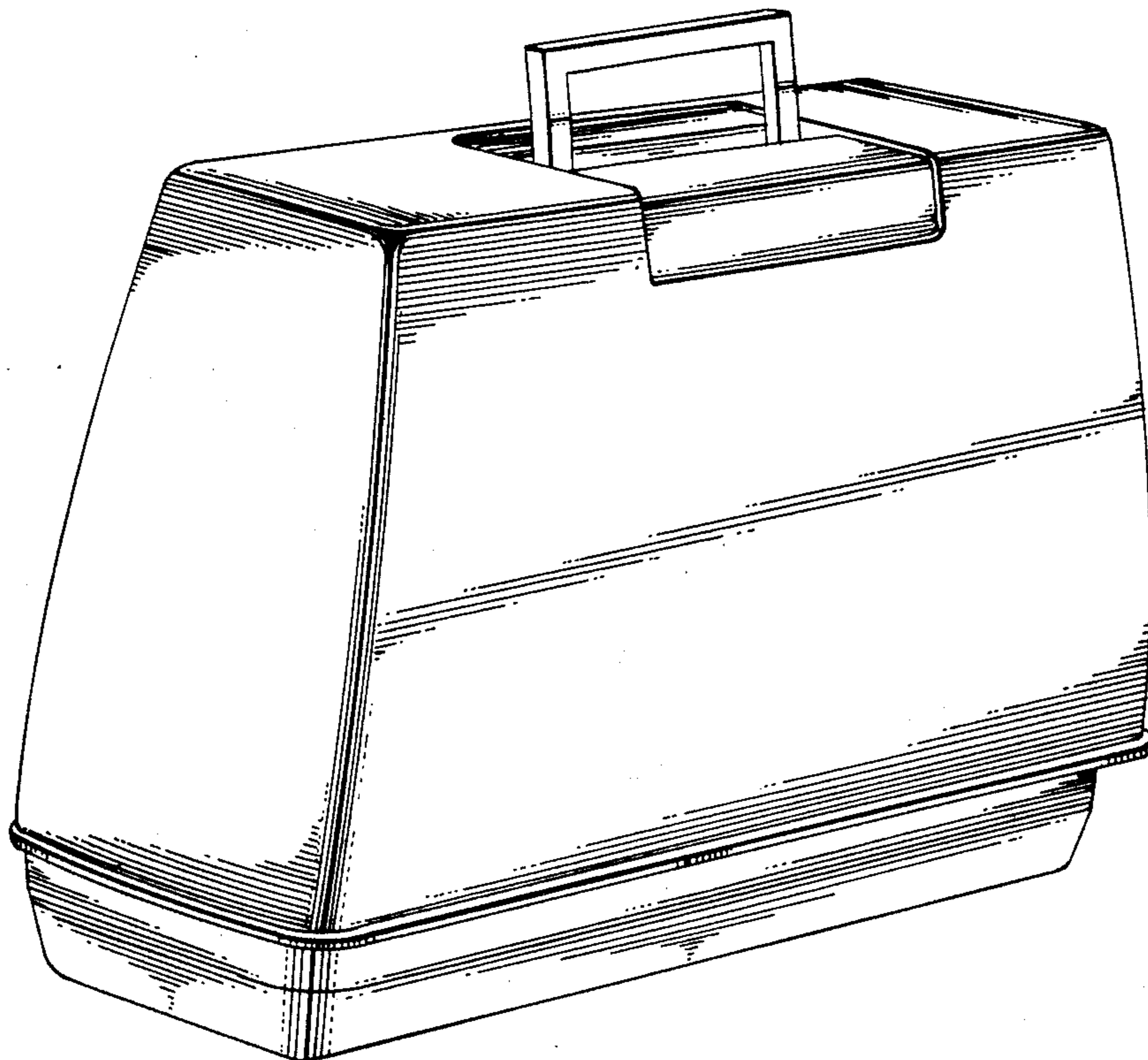

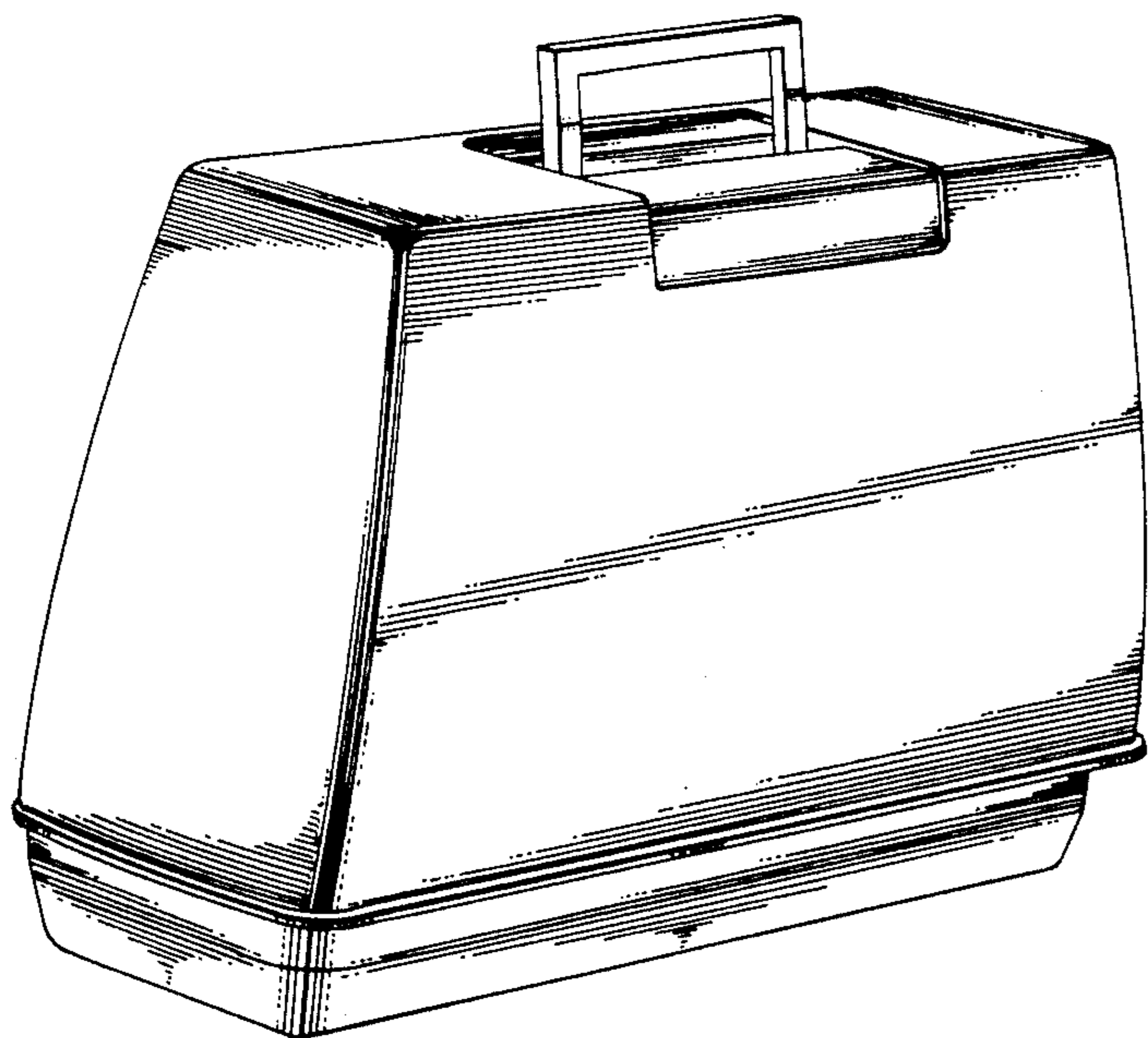

Fig. 1

Fig. 2

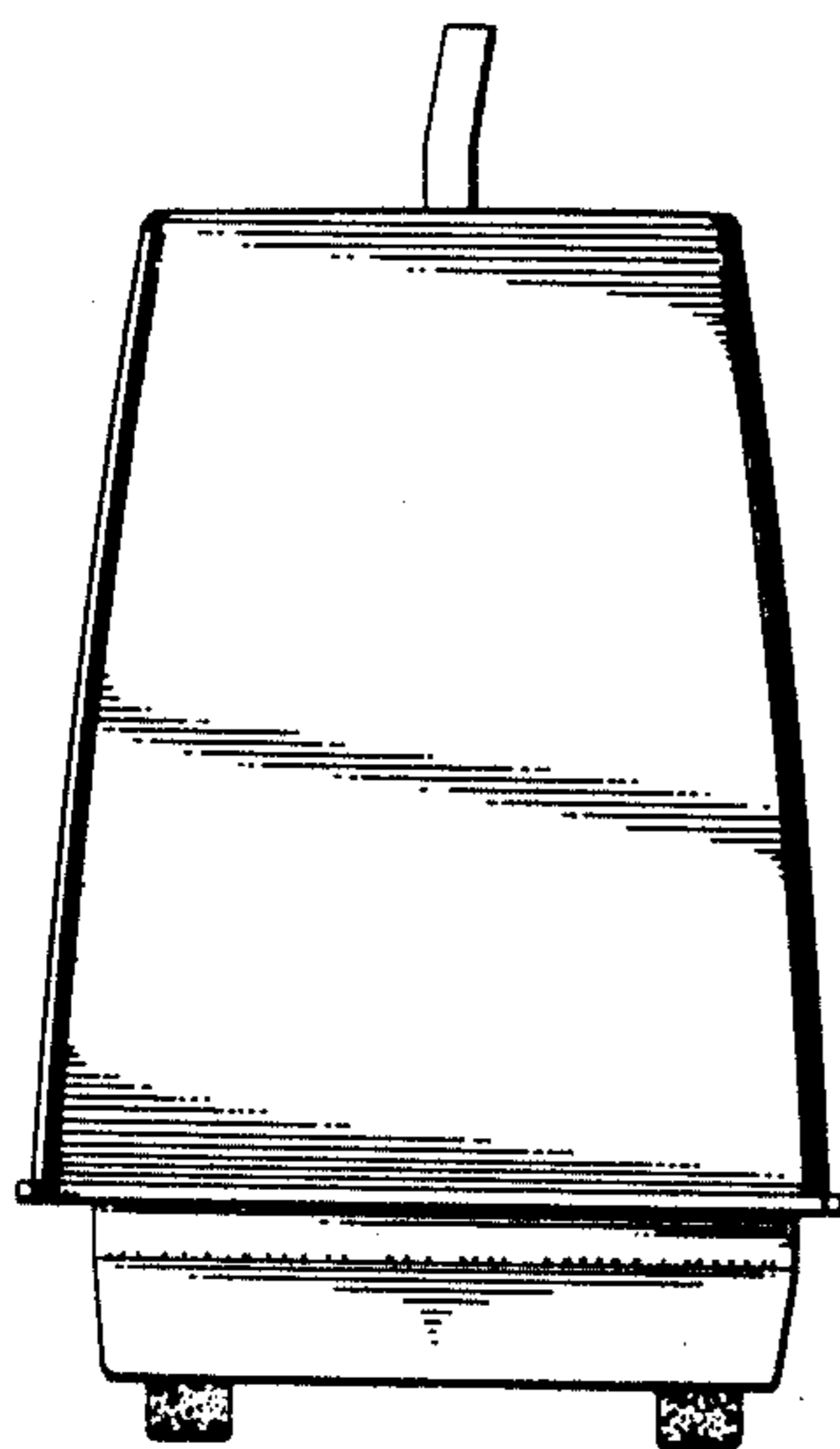

Fig. 3

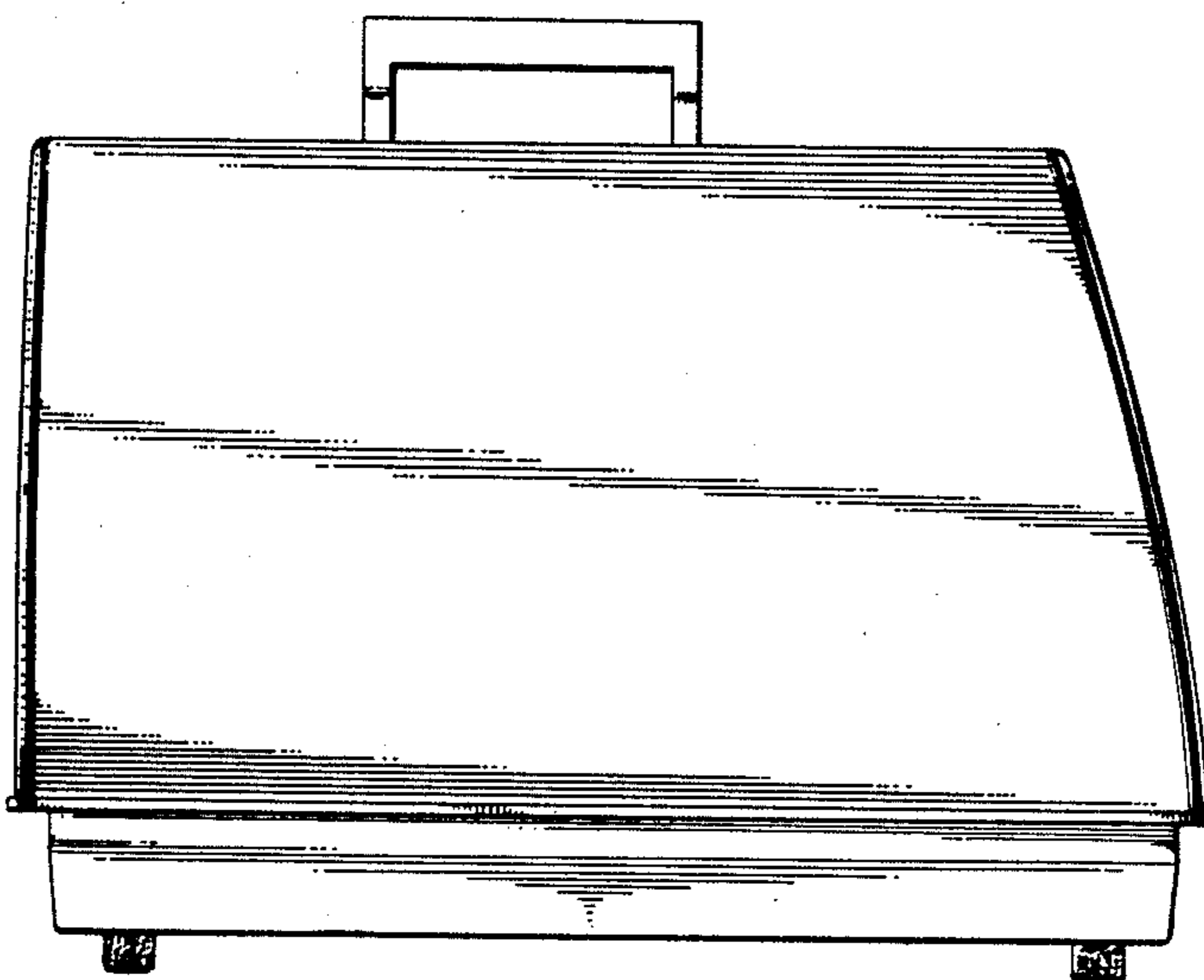

Fig. 4

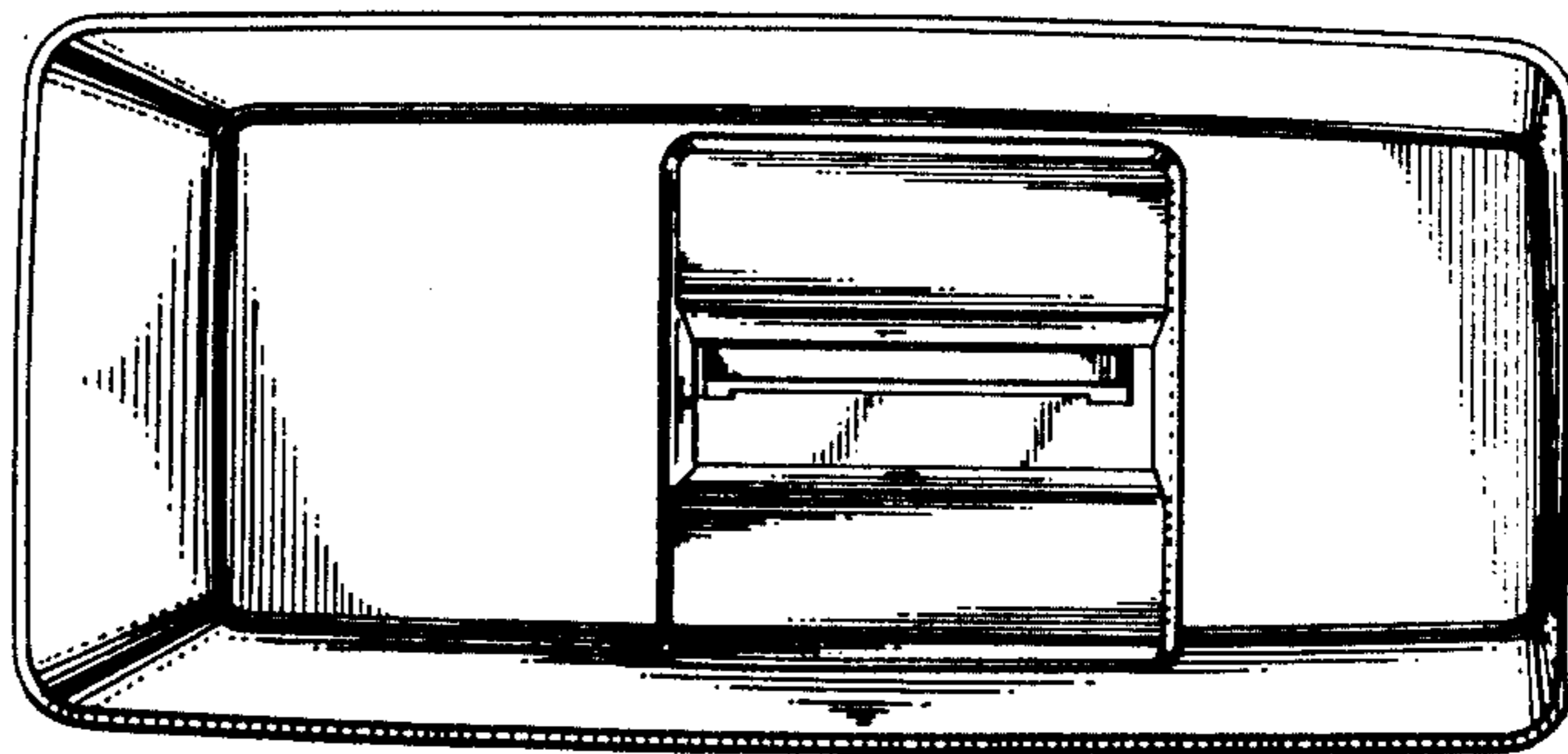

Fig. 5

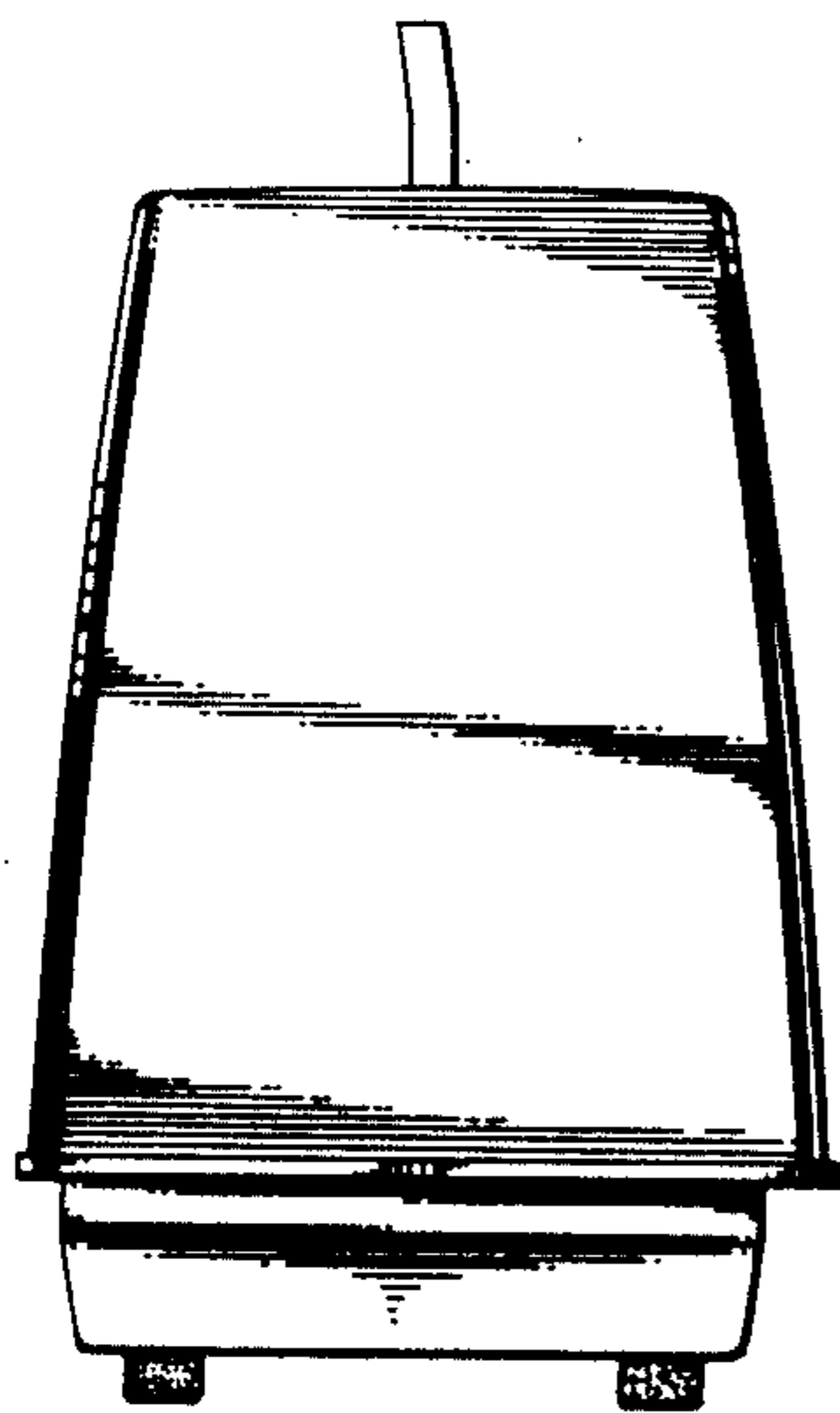

Fig. 6

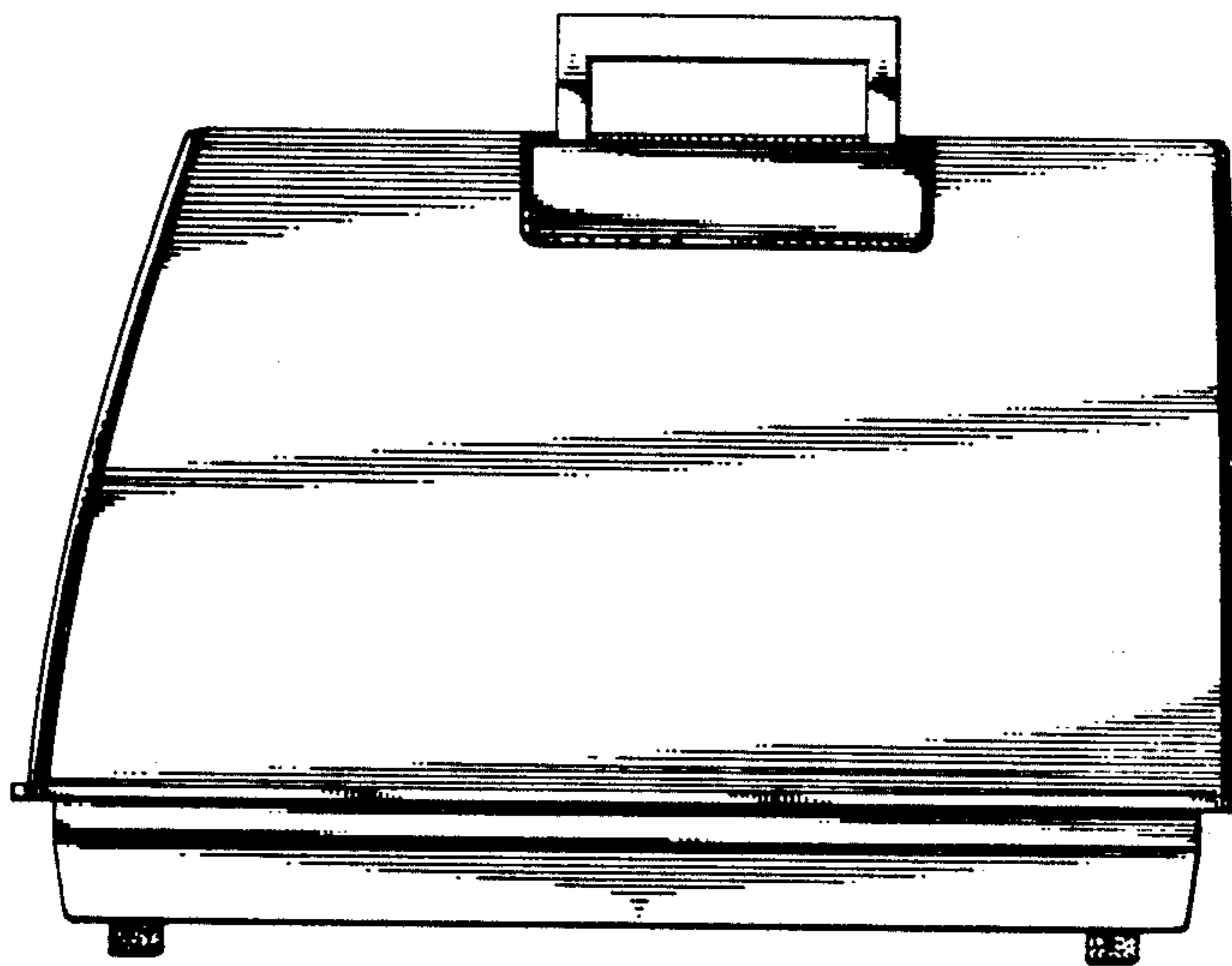
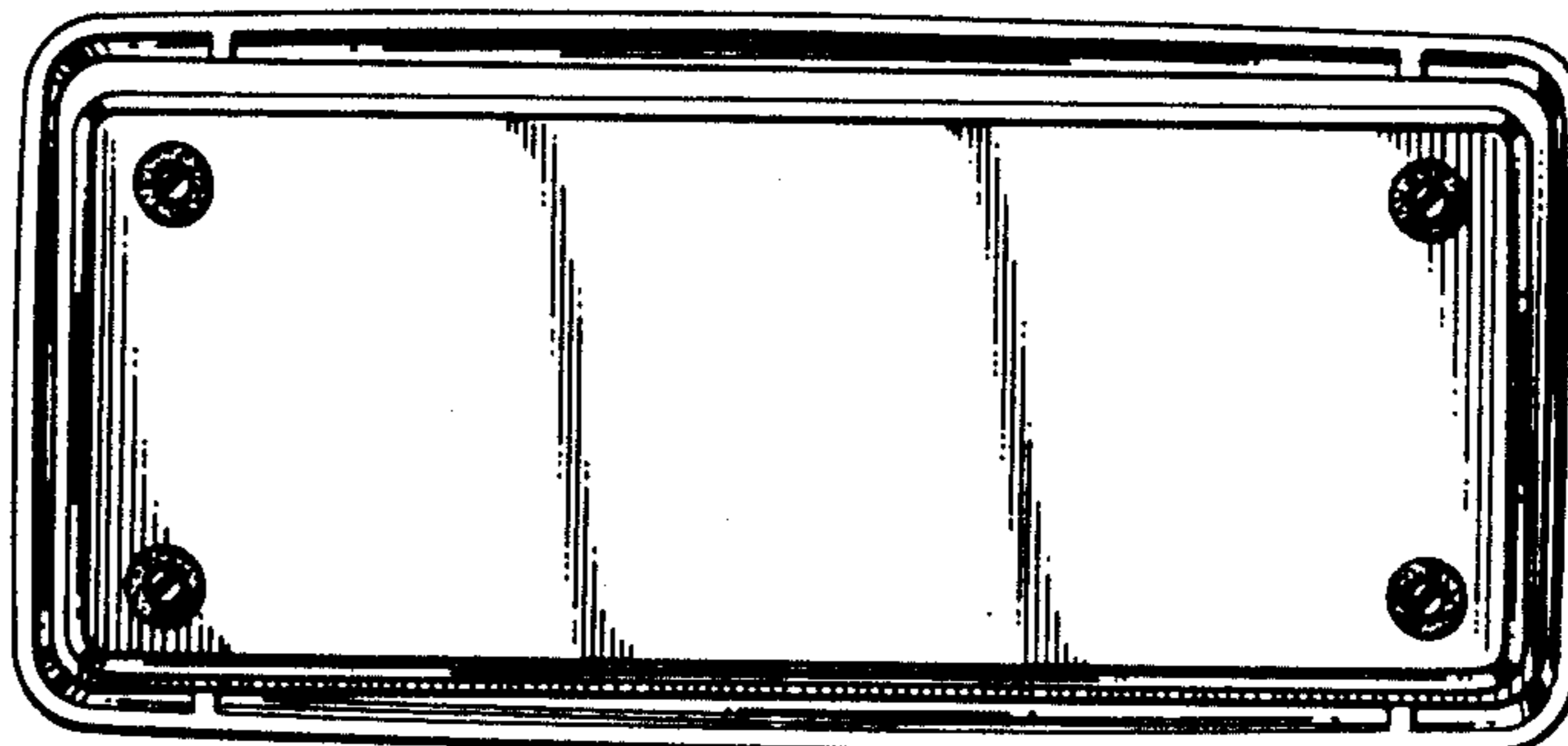

Fig. 7



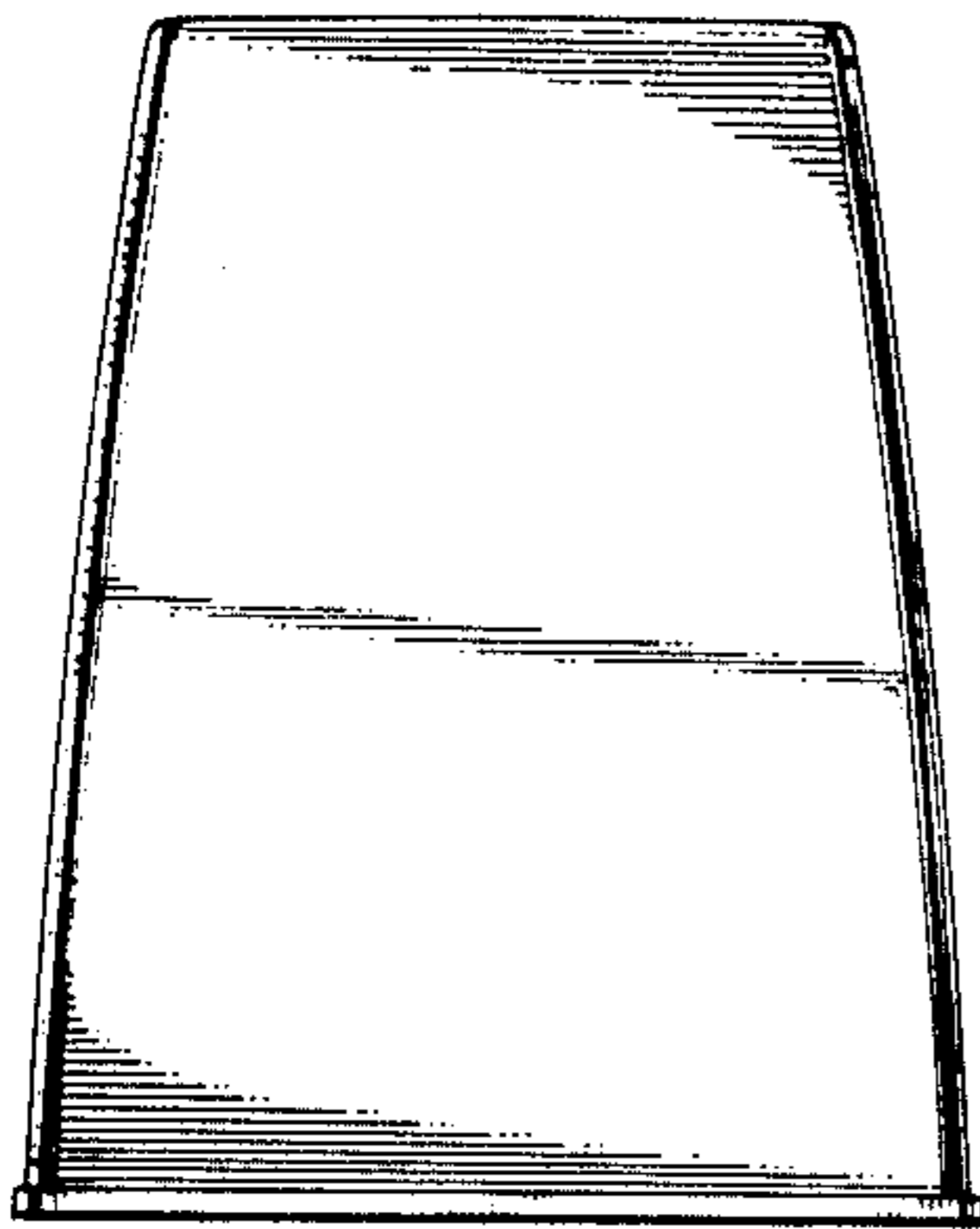

Fig. 8

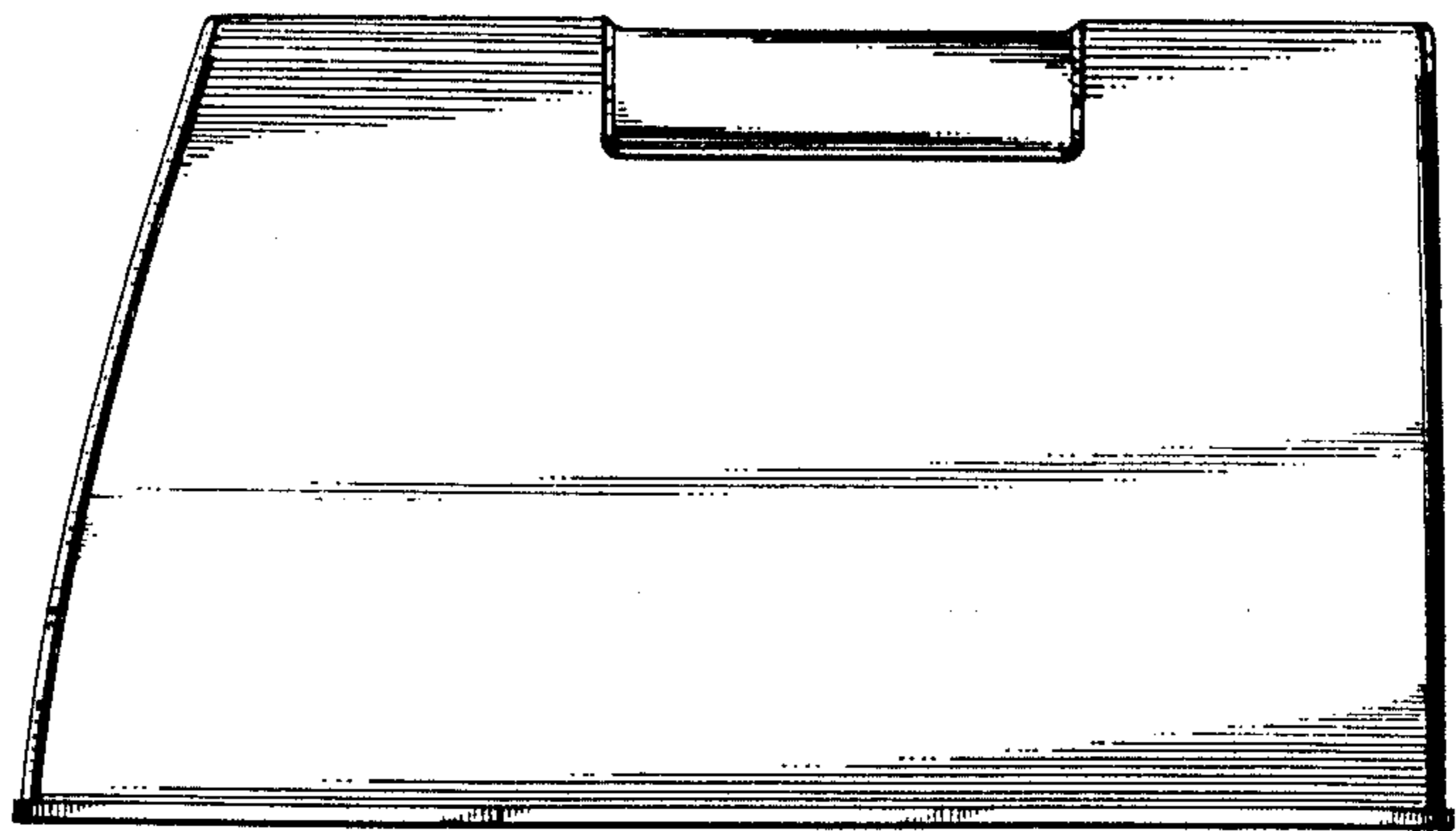

Fig. 9

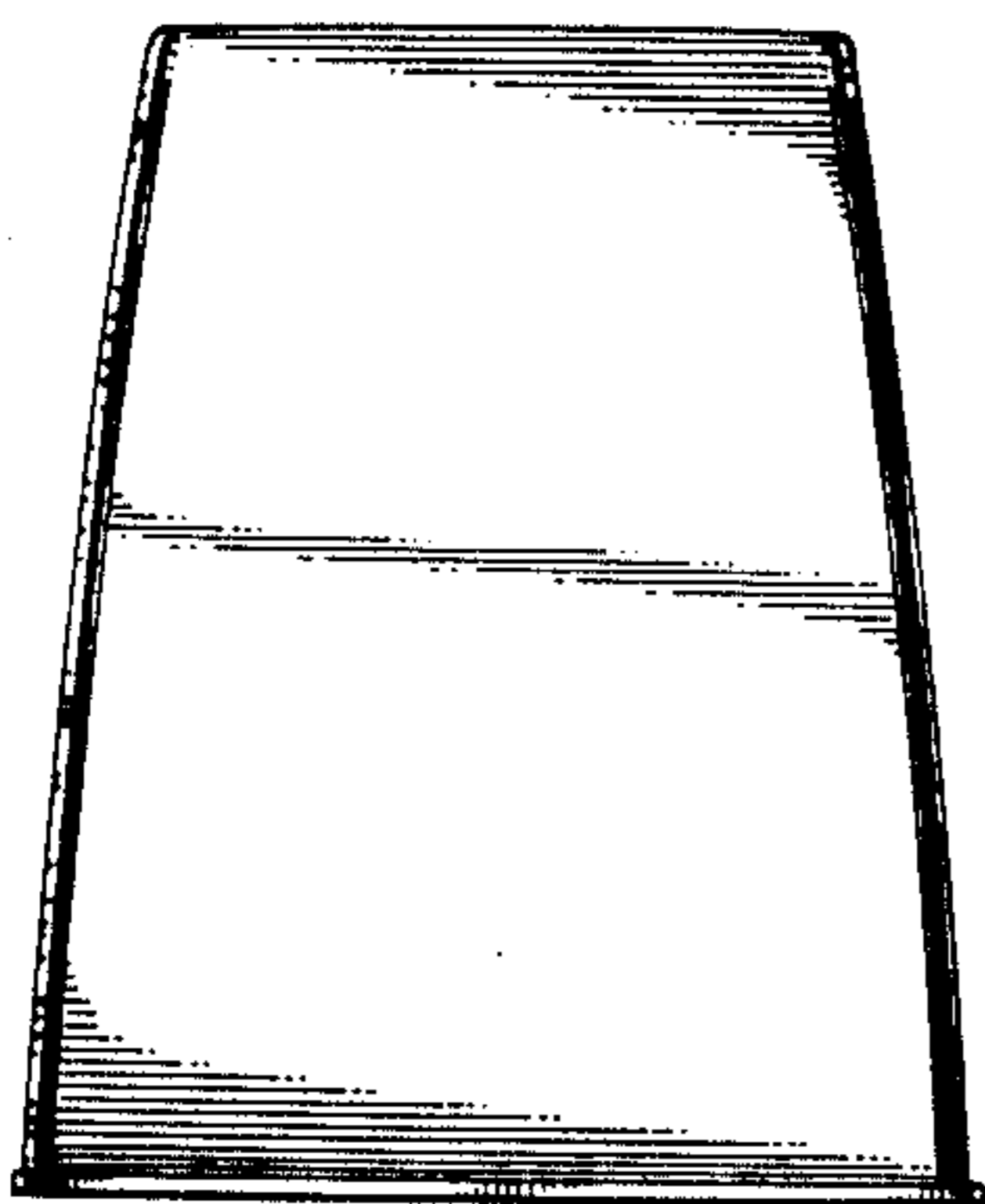

Fig. 10

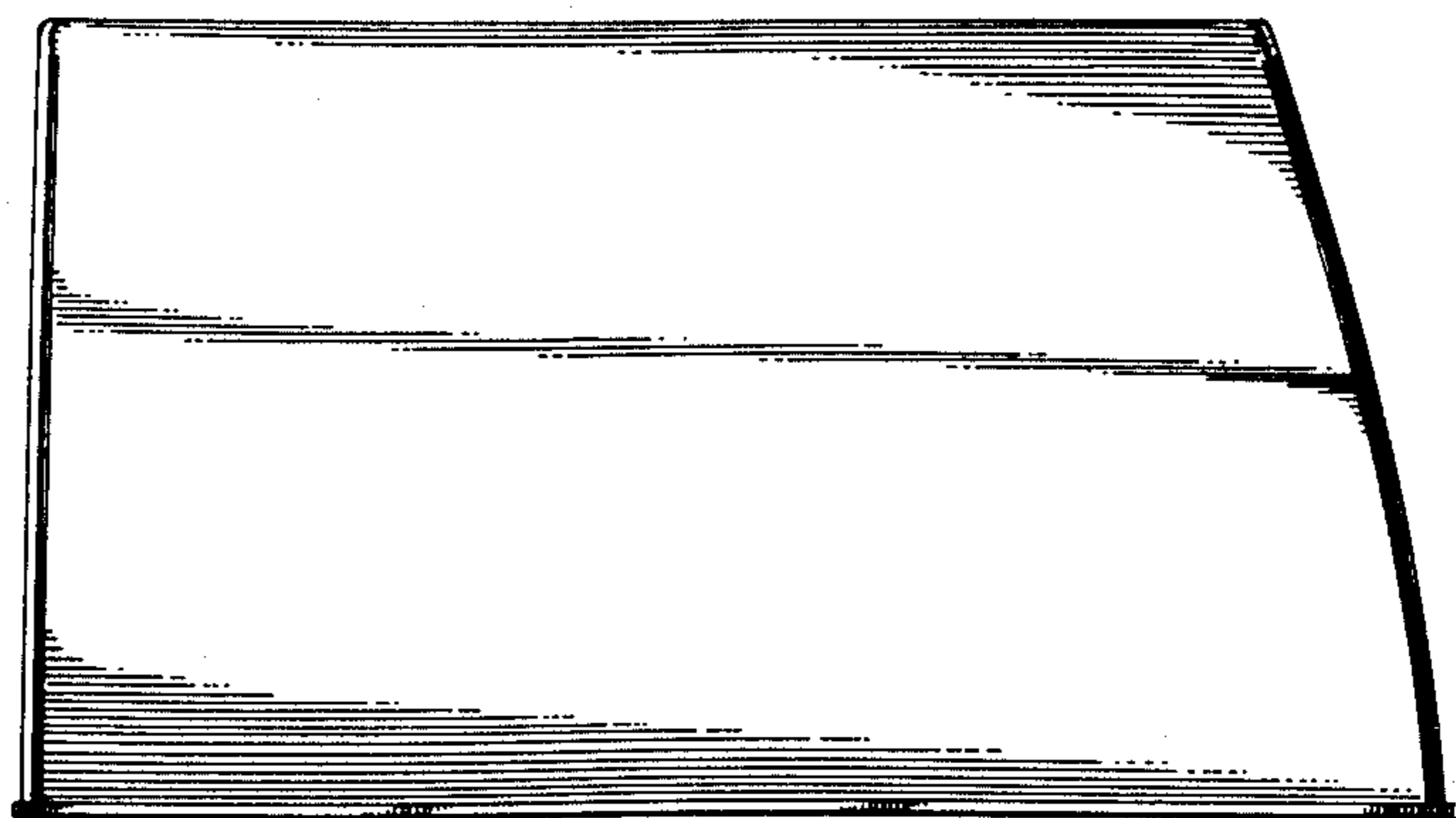

Fig. 11

Fig. 12

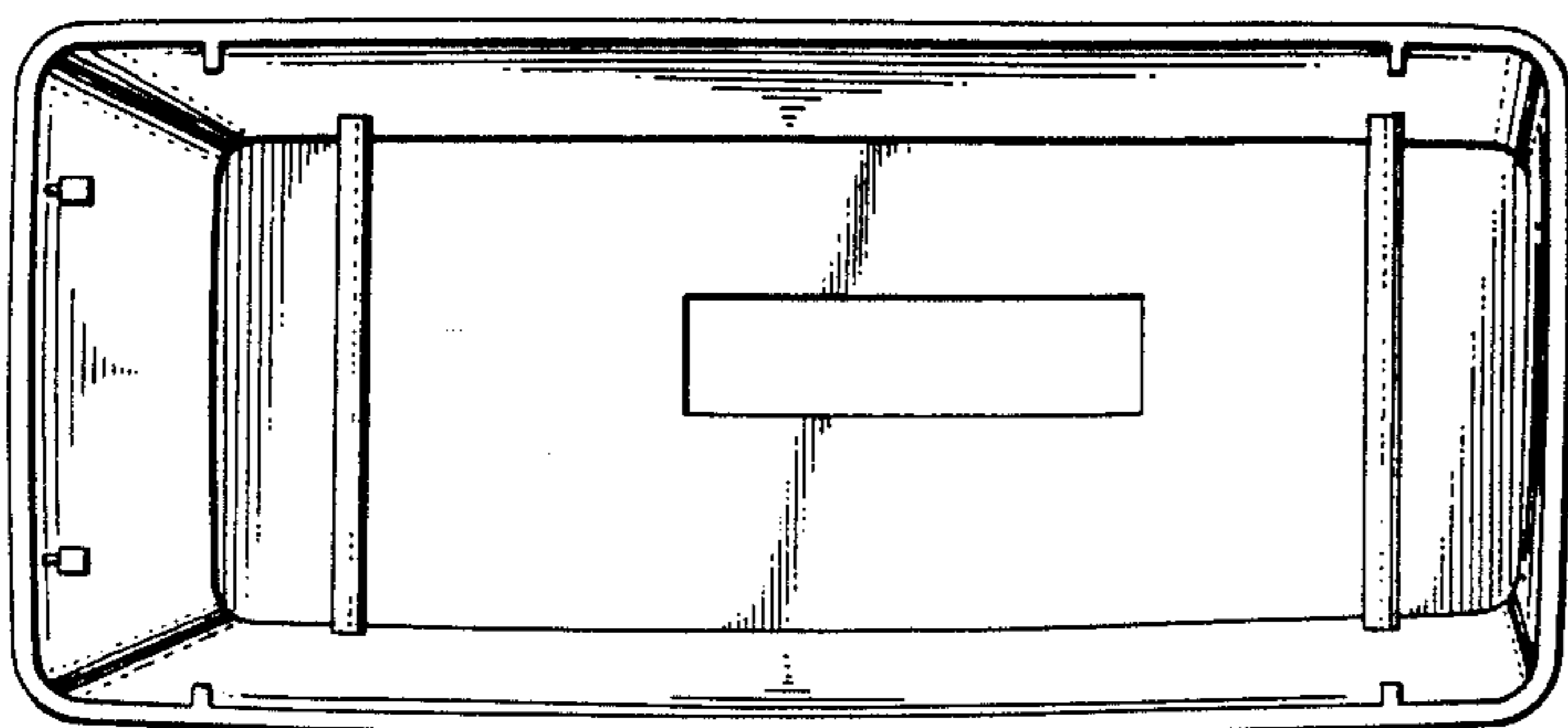
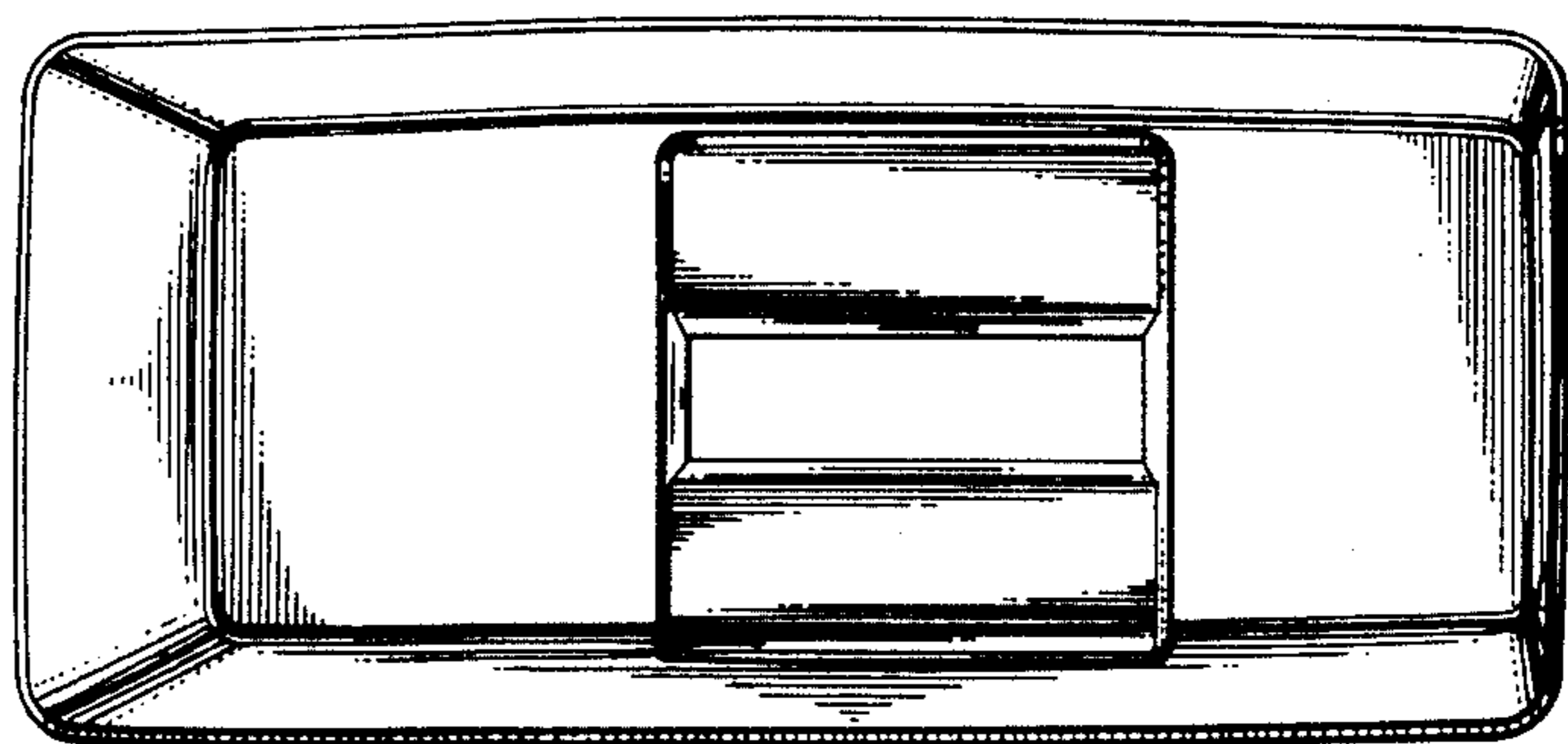

Fig. 13