

[54] SEAT

[76] Inventor: Monte Alpert, 44 Farnsworth St., Boston, Mass. 02210

[**] Term: 14 Years

[21] Appl. No.: 789,429

[22] Filed: Apr. 21, 1977

[51] Int. Cl. D6-01

[52] U.S. Cl. D6/69; D6/73

[58] Field of Search D6/47-78, D6/37-39

[56] References Cited

U.S. PATENT DOCUMENTS

D. 98,889	3/1936	Posser et al.	D6/69
D. 108,877	3/1938	Johnson	D6/69
D. 203,262	12/1965	Davison	D6/69
D. 211,983	8/1968	Kilper	D6/69
D. 217,345	4/1970	Pitt	D6/69
D. 242,310	11/1976	Fister	D6/69
D. 242,886	1/1977	Potter	D6/63 X

OTHER PUBLICATIONS

Interiors, 8-1974, p. 69, Chair by Davis Furn. Co.

Primary Examiner—Bruce W. Dunkins

Attorney, Agent, or Firm—Arthur Z. Bookstein

[57] CLAIM

The ornamental design for a seat, as shown and described.

DESCRIPTION

FIG. 1 is a front perspective view of a seat showing my design in the form of a chair;

FIG. 2 is a front elevation thereof;

FIG. 3 is a side elevation of the chair shown in each of FIGS. 1, 7 and 8;

FIG. 4 is a rear elevation thereof;

FIG. 5 is a top plan view thereof;

FIG. 6 is a bottom plan view thereof;

FIG. 7 is a front perspective view of the seat of FIG. 1 shown in the form of a loveseat; and

FIG. 8 is a front perspective view of the seat of FIG. 1 shown in the form of a sofa.

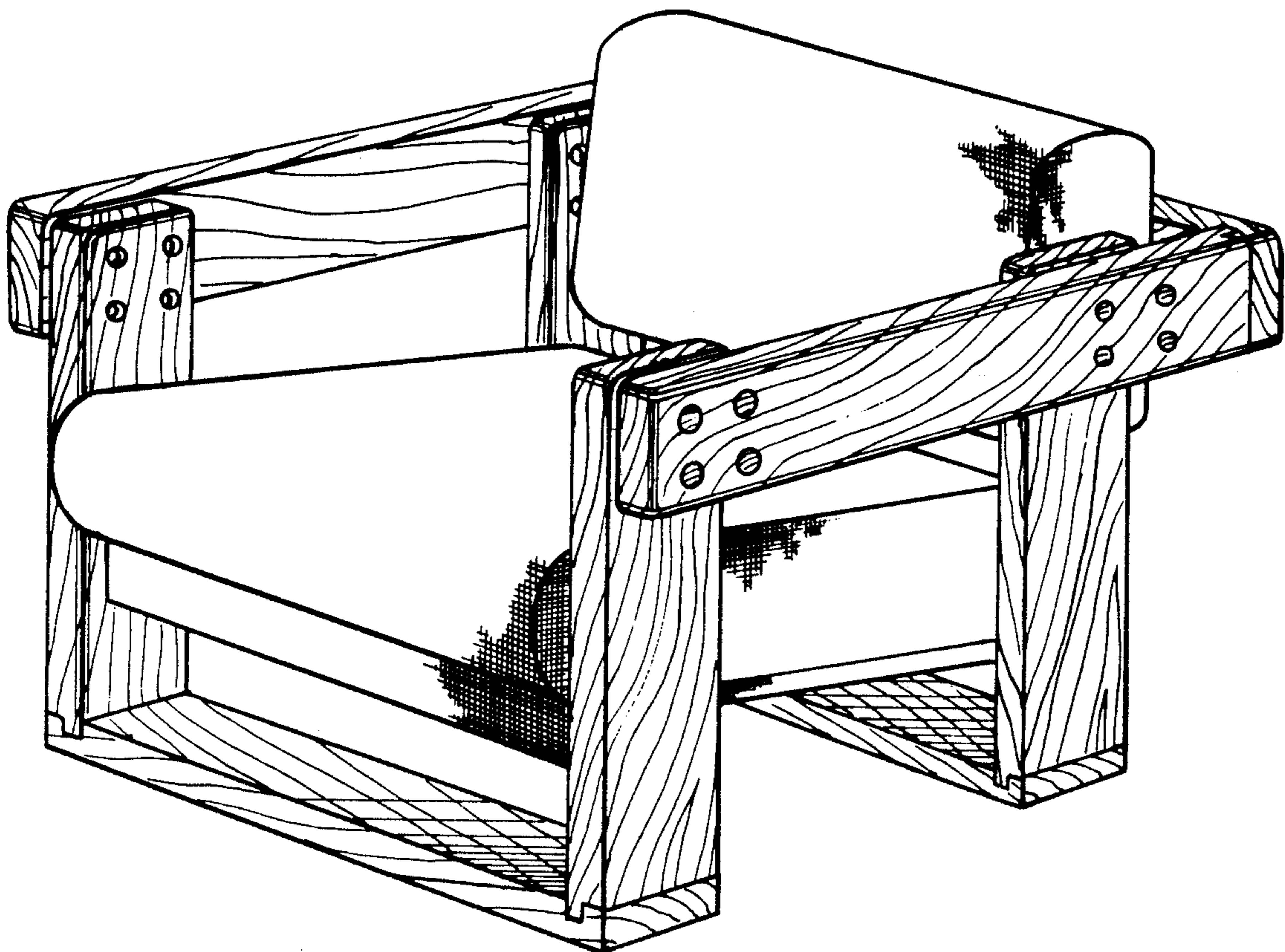

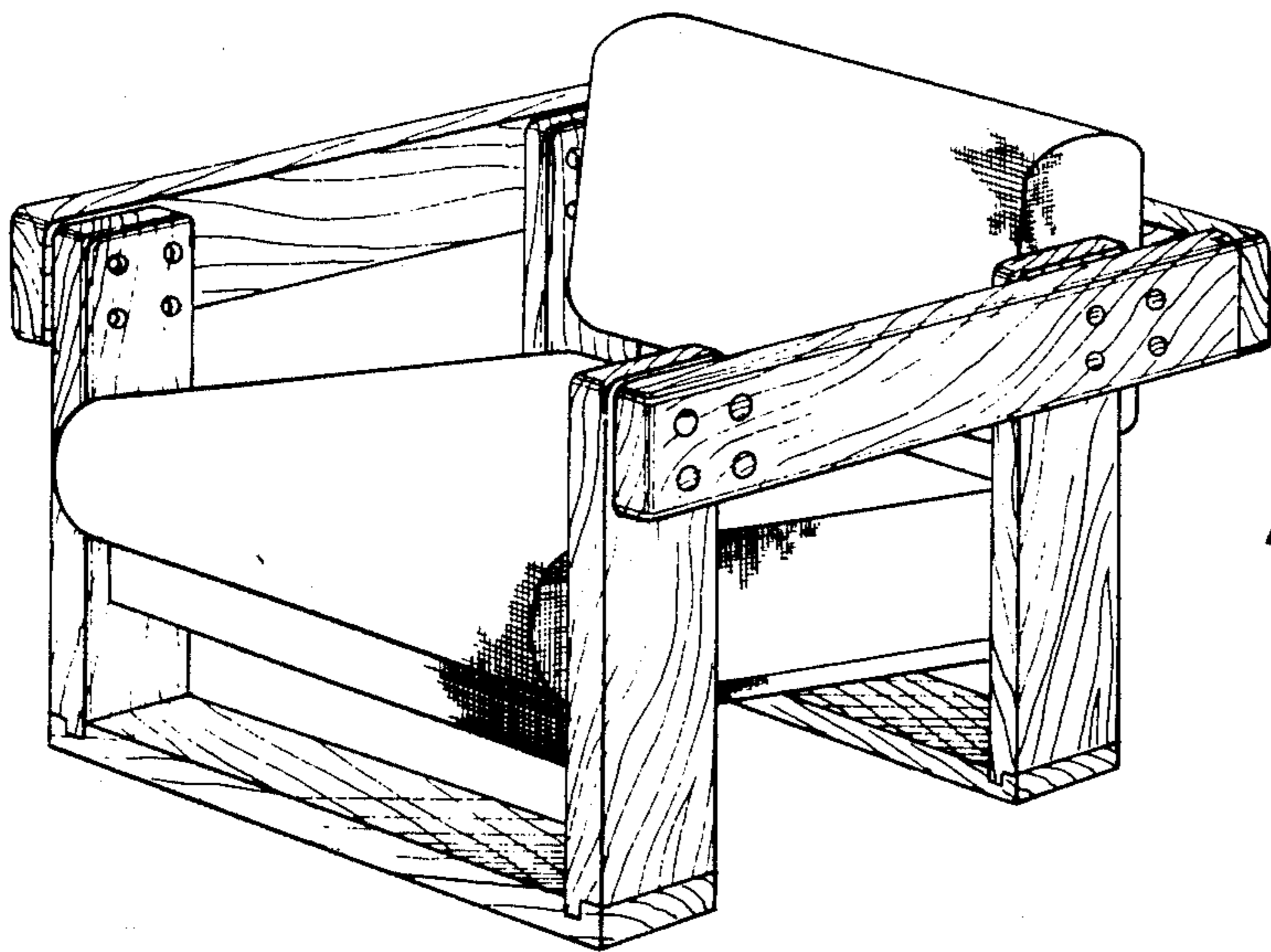

Fig. 1

Fig. 2

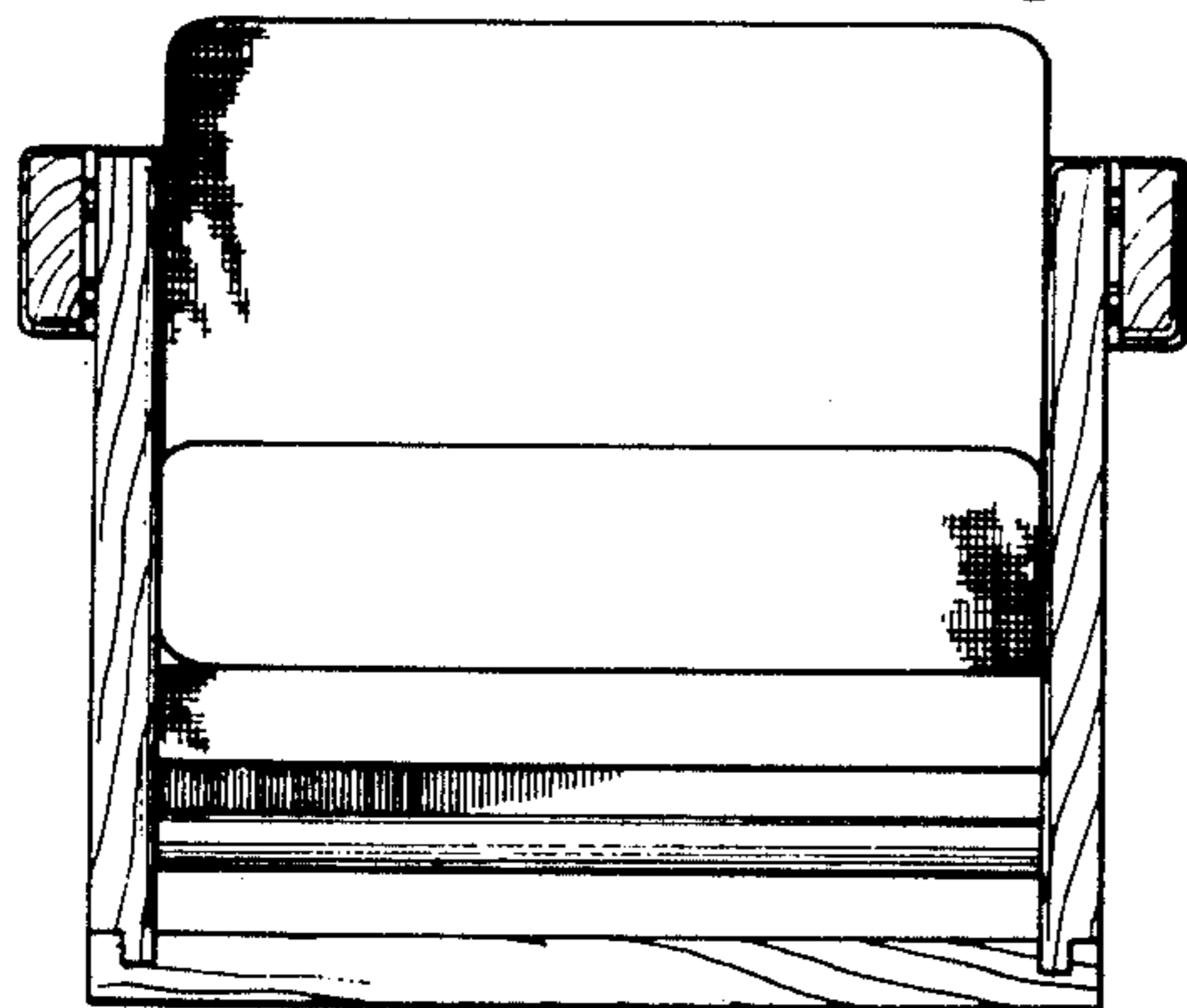

Fig. 3

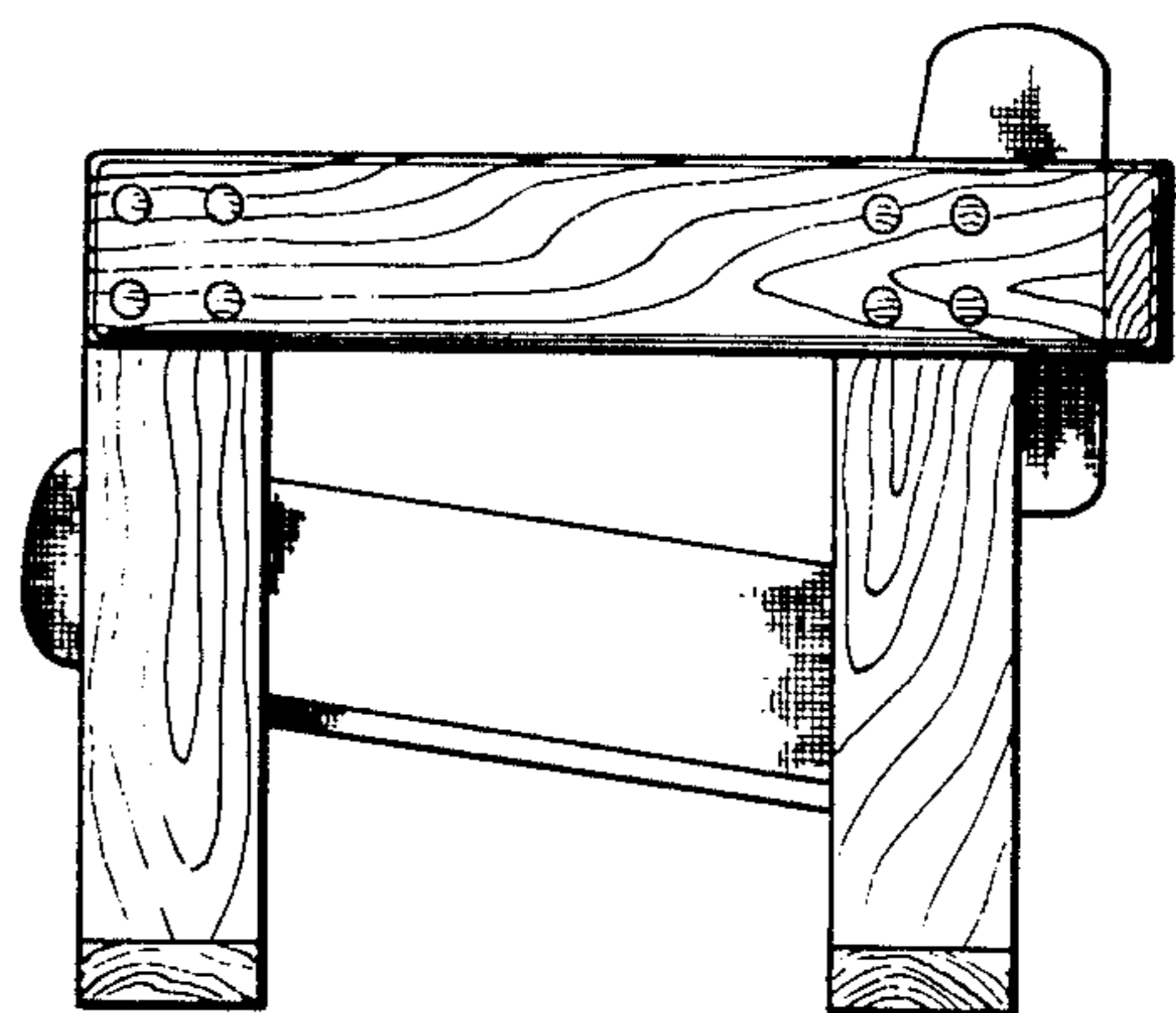

Fig. 4

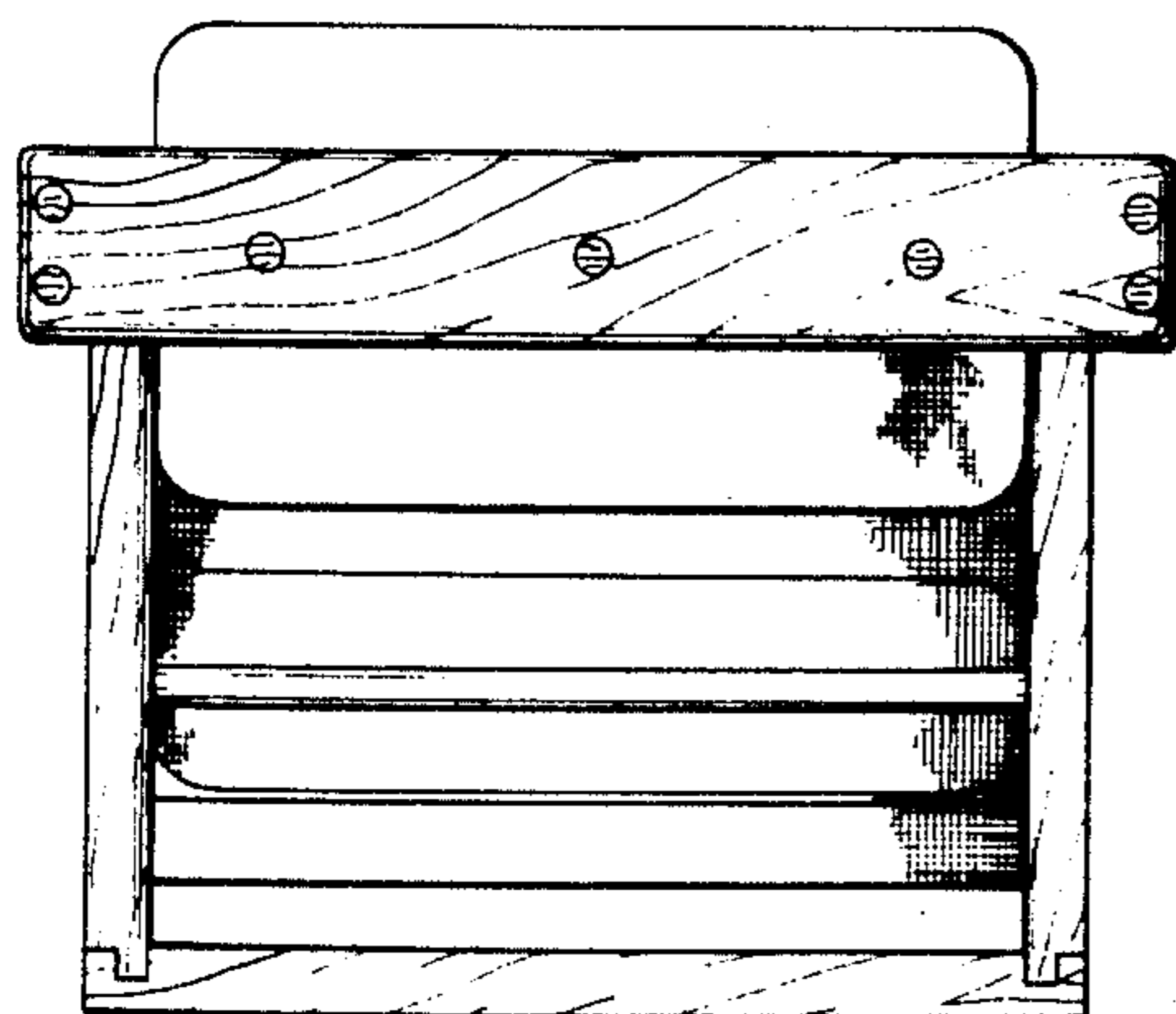

Fig. 5

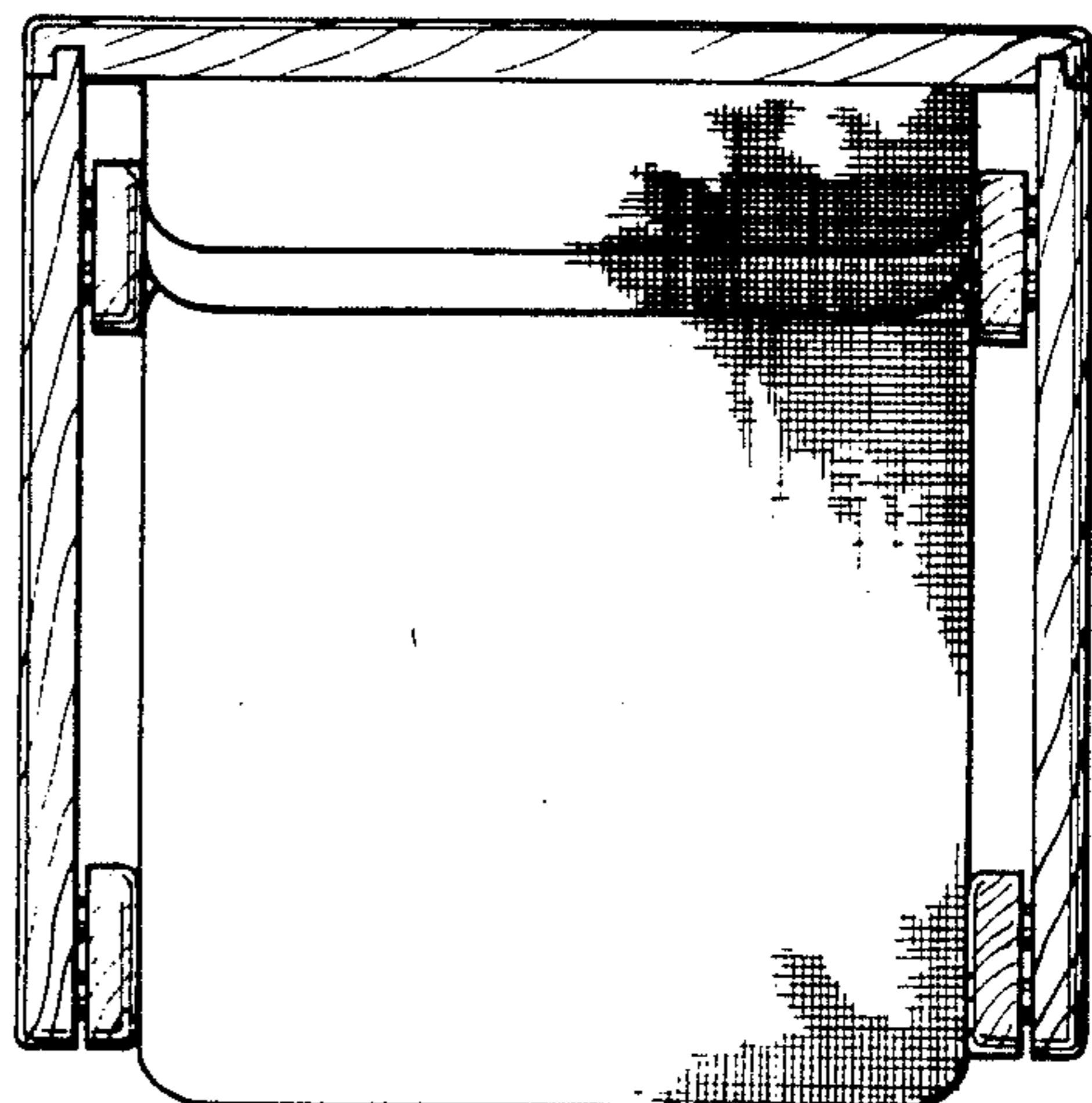

Fig. 6

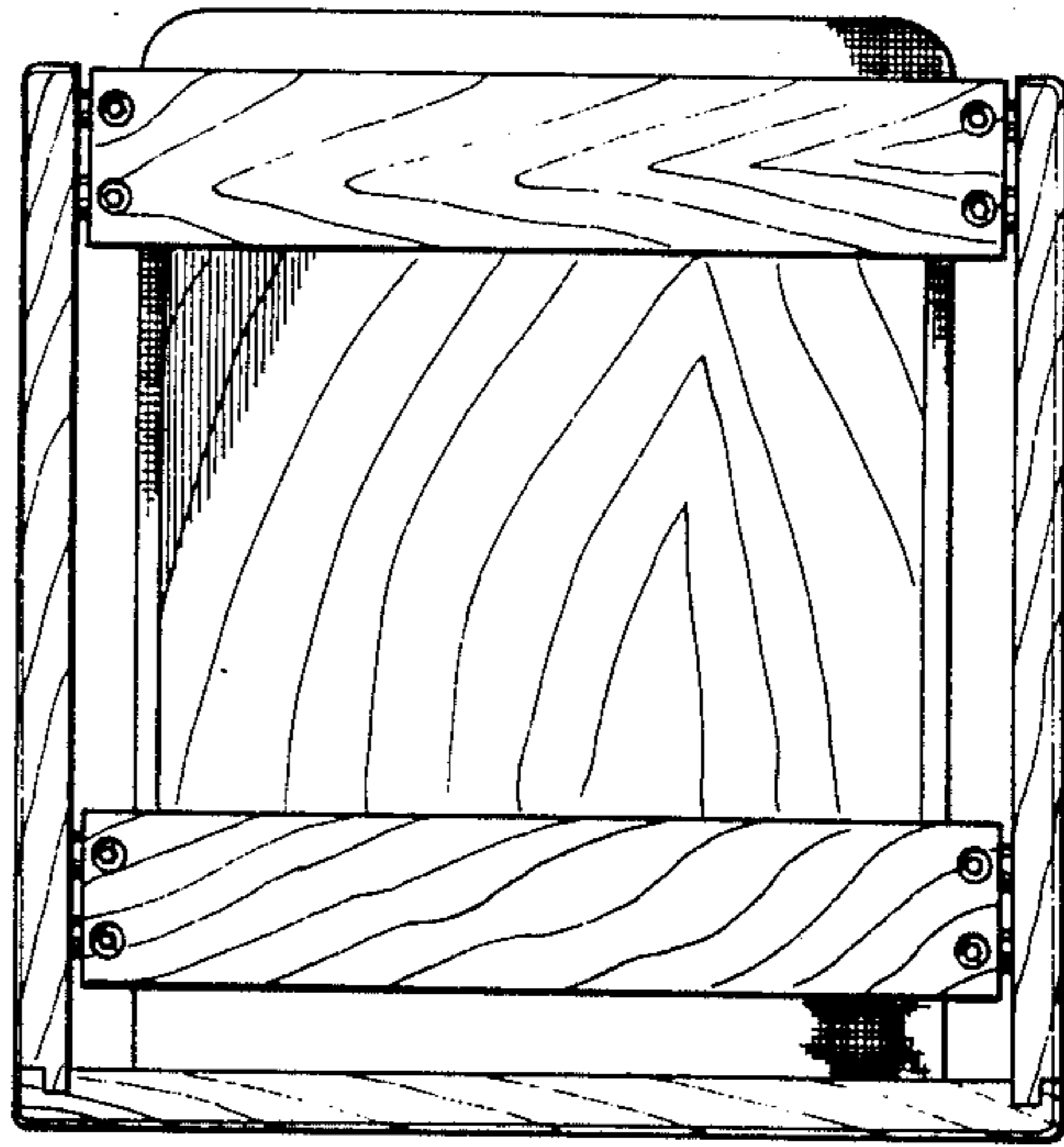

Fig. 7

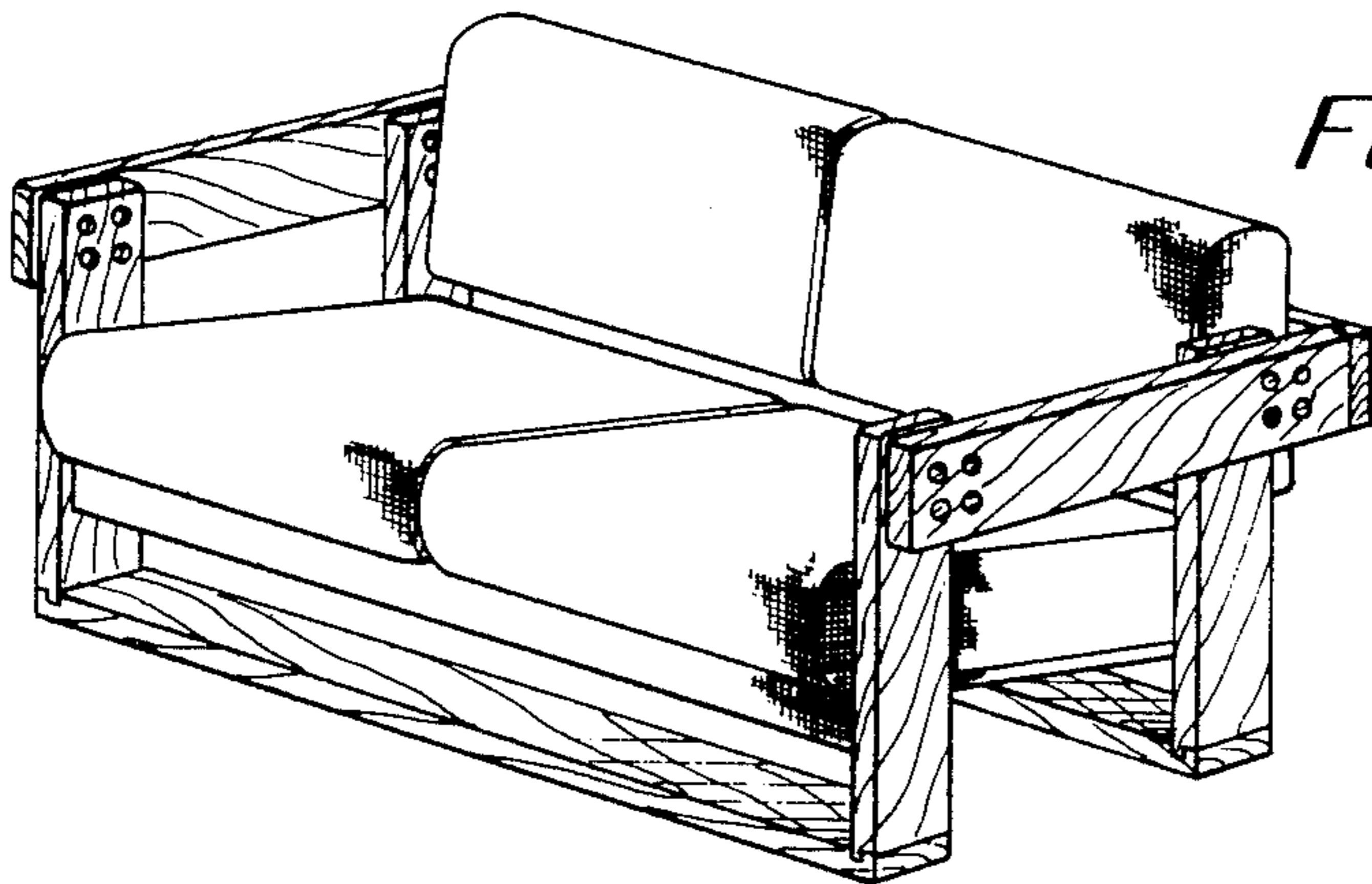

Fig. 8

