

[54] COMBINED BOTTLE AND CAP OR SIMILAR ARTICLE

[75] Inventors: Allen H. Strang, Ridgewood; Emil Polito, Paramus, both of N.J.

[73] Assignee: American Cyanamid Company, Stamford, Conn.

[**] Term: 14 Years

[21] Appl. No.: 693,583

[22] Filed: Jun. 7, 1976

[51] Int. Cl. D9-01

[52] U.S. Cl. D9/168

[58] Field of Search D9/119-131, D9/158-169

[56] References Cited

U.S. PATENT DOCUMENTS

- D. 132,914 6/1942 Marquis D9/166
- D. 203,074 11/1965 Adell D9/158
- D. 237,855 12/1975 Achenbach D9/164 X

Primary Examiner—Robert C. Spangler
Attorney, Agent, or Firm—Charles J. Fickey

[57] CLAIM

The ornamental design for a combined bottle and cap or similar article, substantially as shown and described.

DESCRIPTION

FIG. 1 is a front elevational view of a combined bottle and cap or similar article showing our new design;

FIG. 2 is a side elevational view thereof with a portion broken away for convenience of illustration;

FIG. 3 is a cross sectional view taken along the lines 3—3, of FIG. 1;

FIG. 4 is a cross sectional view taken along the lines 4—4, of FIG. 1;

FIG. 5 is a cross sectional view taken along the lines 5—5, of FIG. 1;

FIG. 6 is a cross sectional view taken along the lines 6—6, of FIG. 1; and

FIG. 7 is a cross-sectional view taken along the lines 7—7 of FIG. 2.

The two circular areas on the top sphere represent internal bubbles.

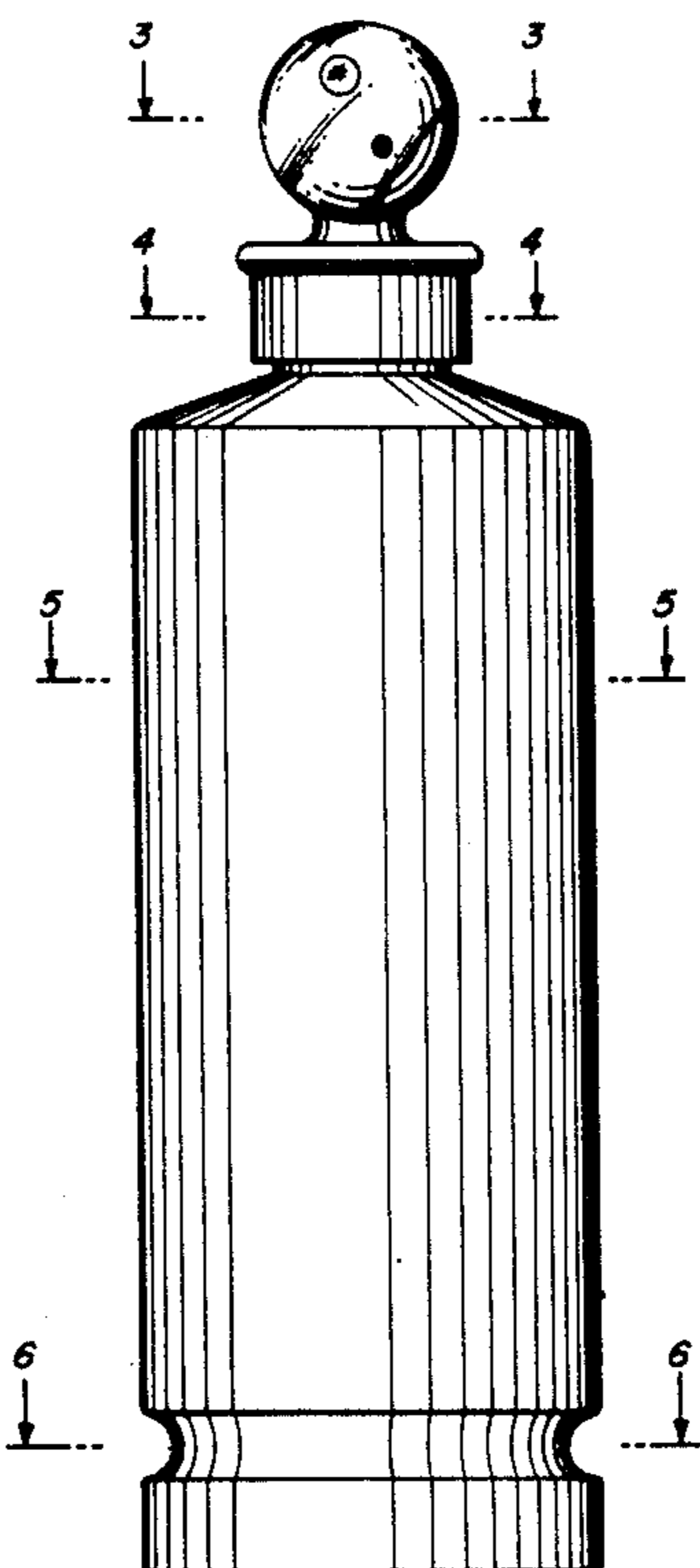

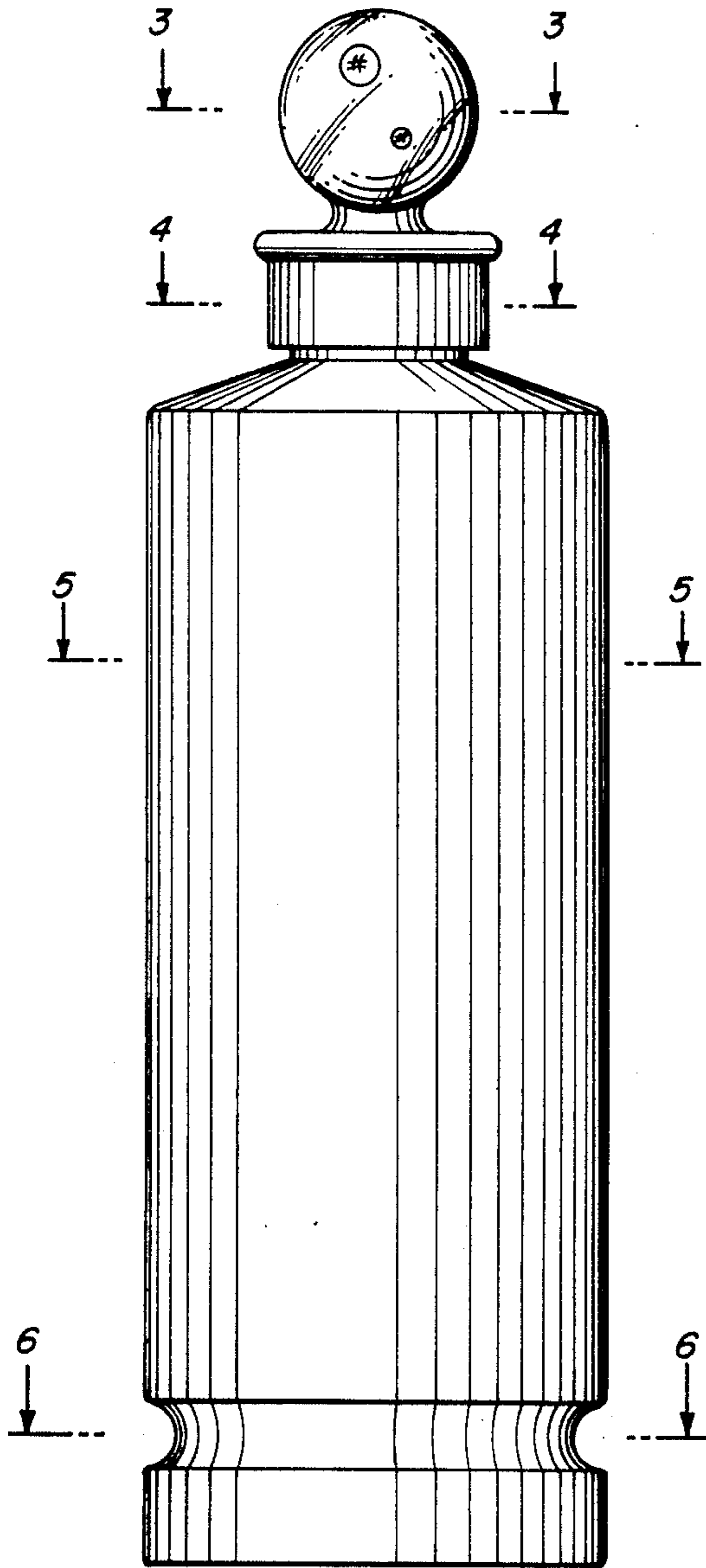

FIG. 1

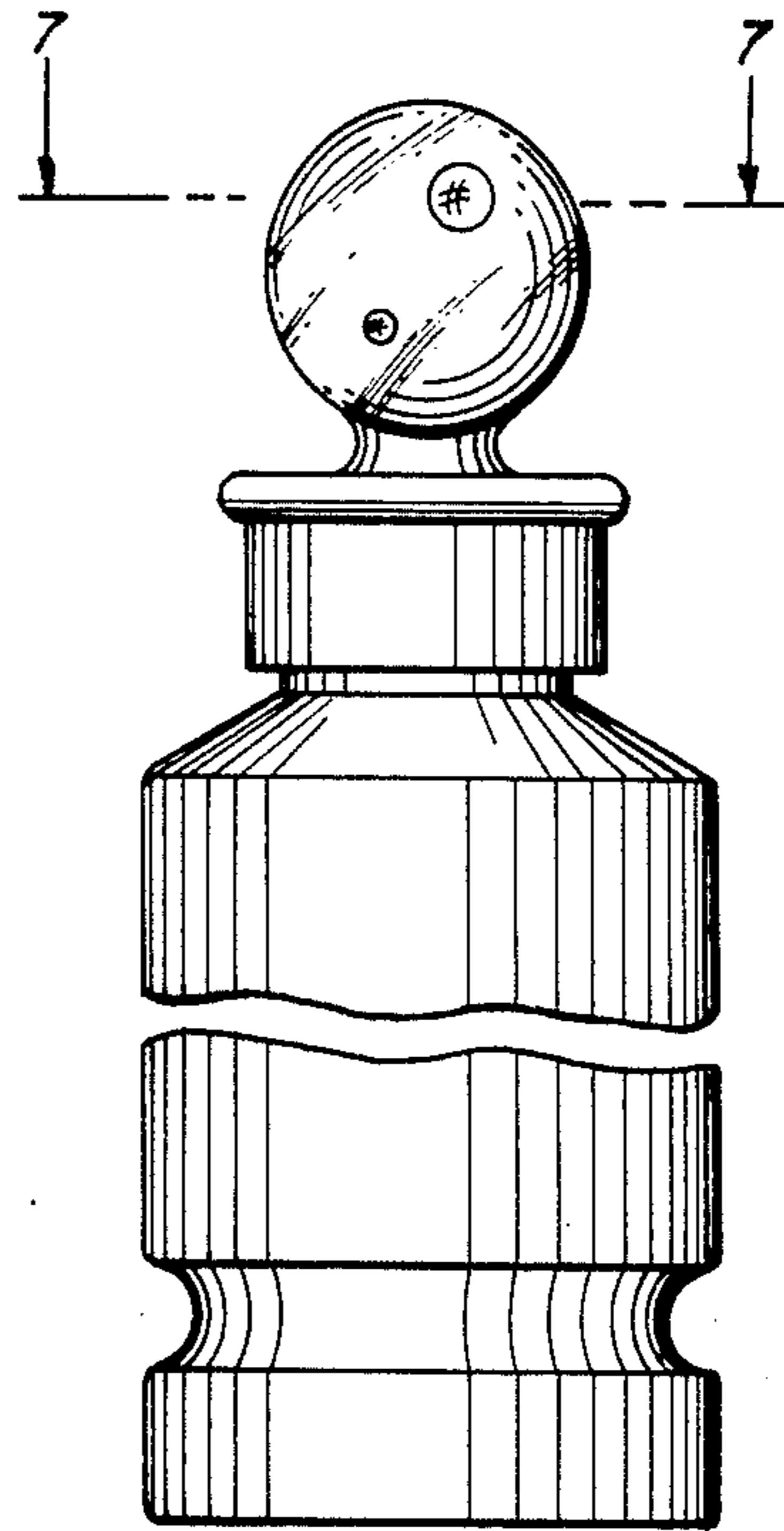

FIG. 2

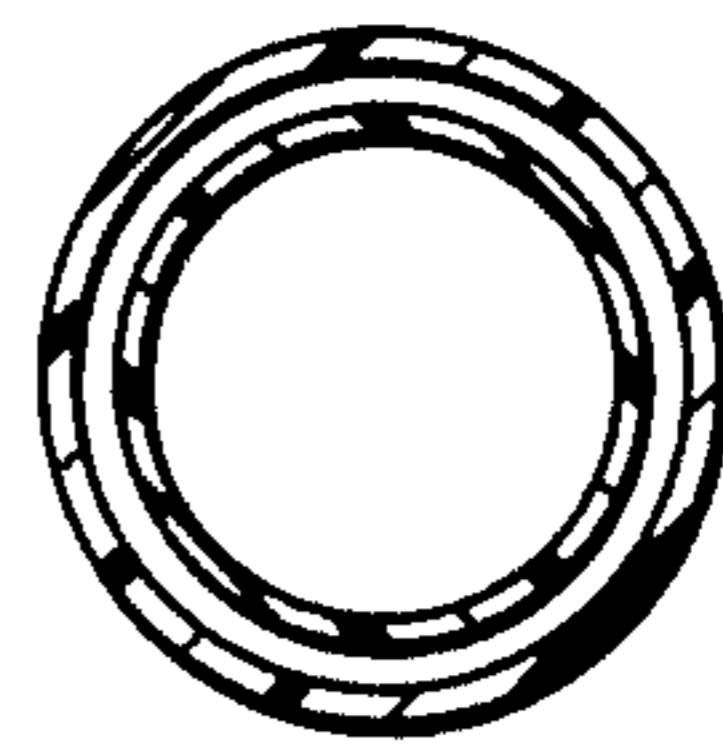

FIG. 4

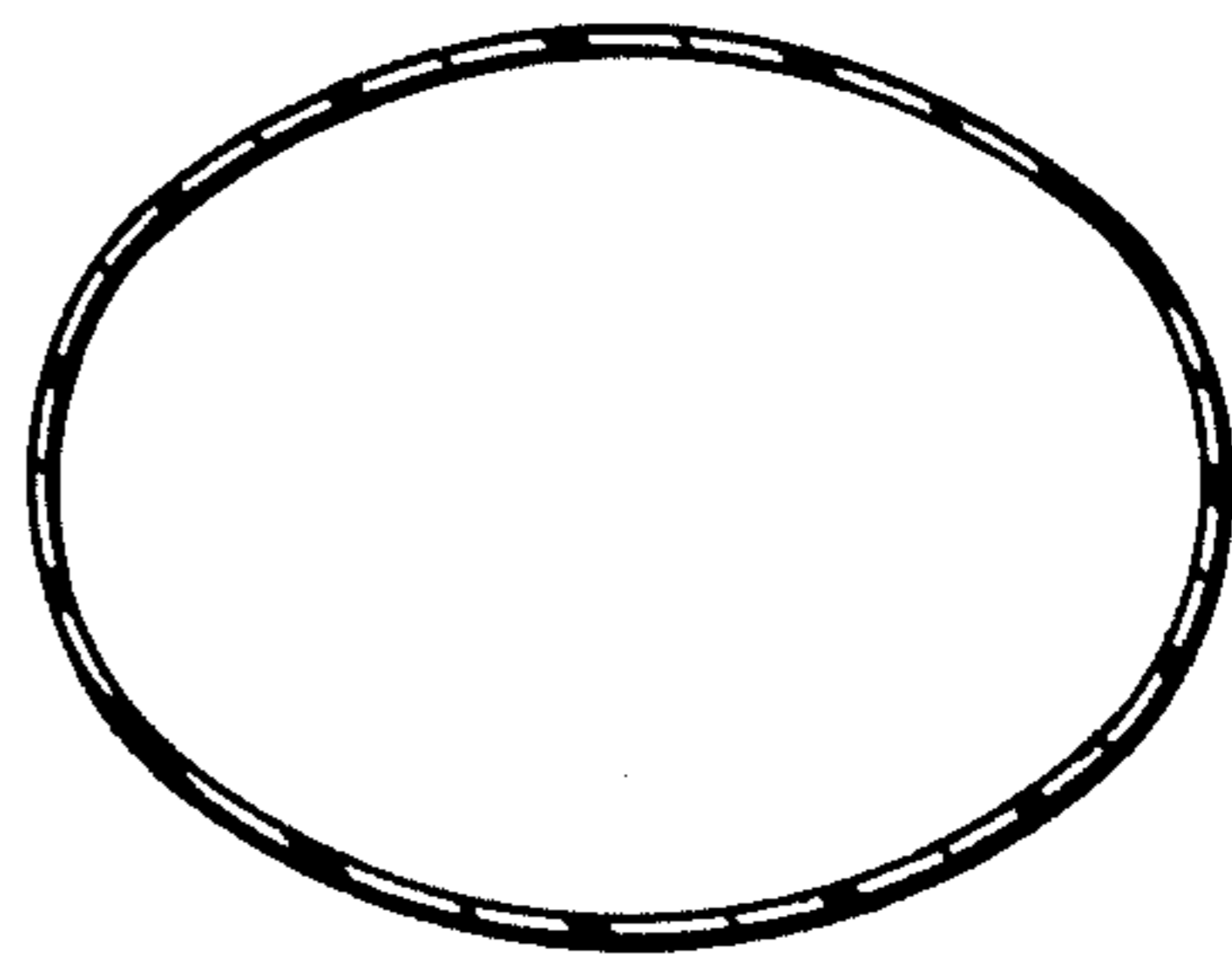

FIG. 5

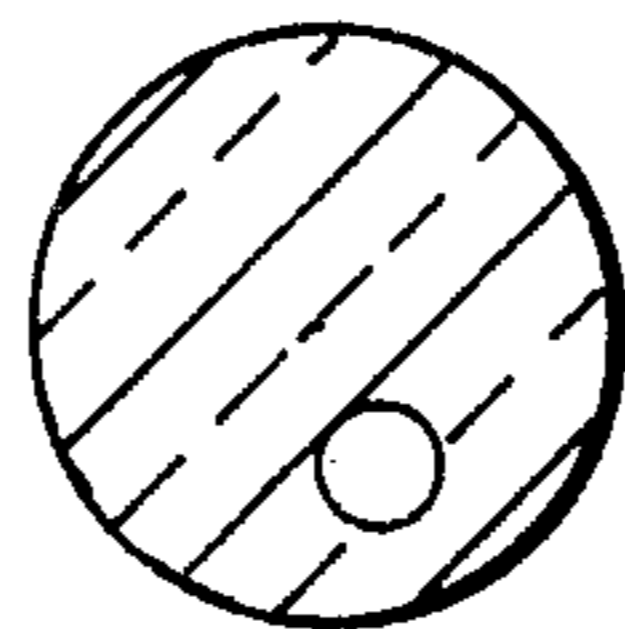

FIG. 7

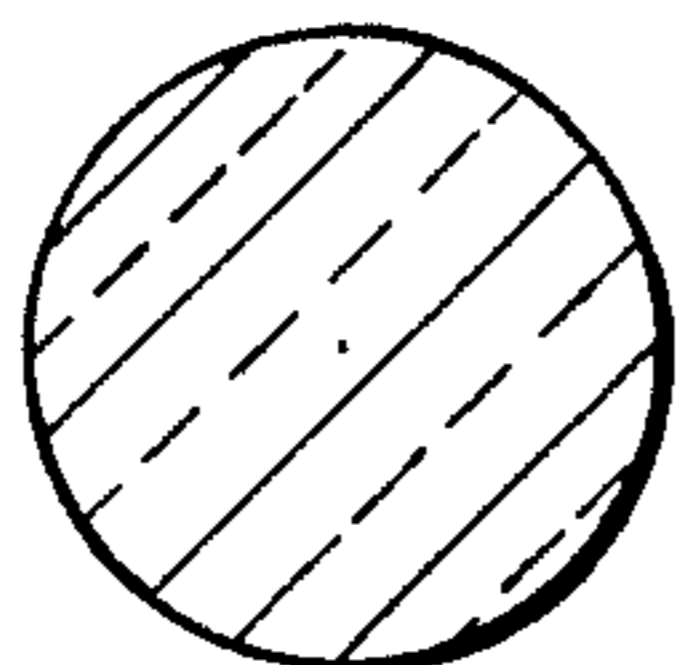

FIG. 3

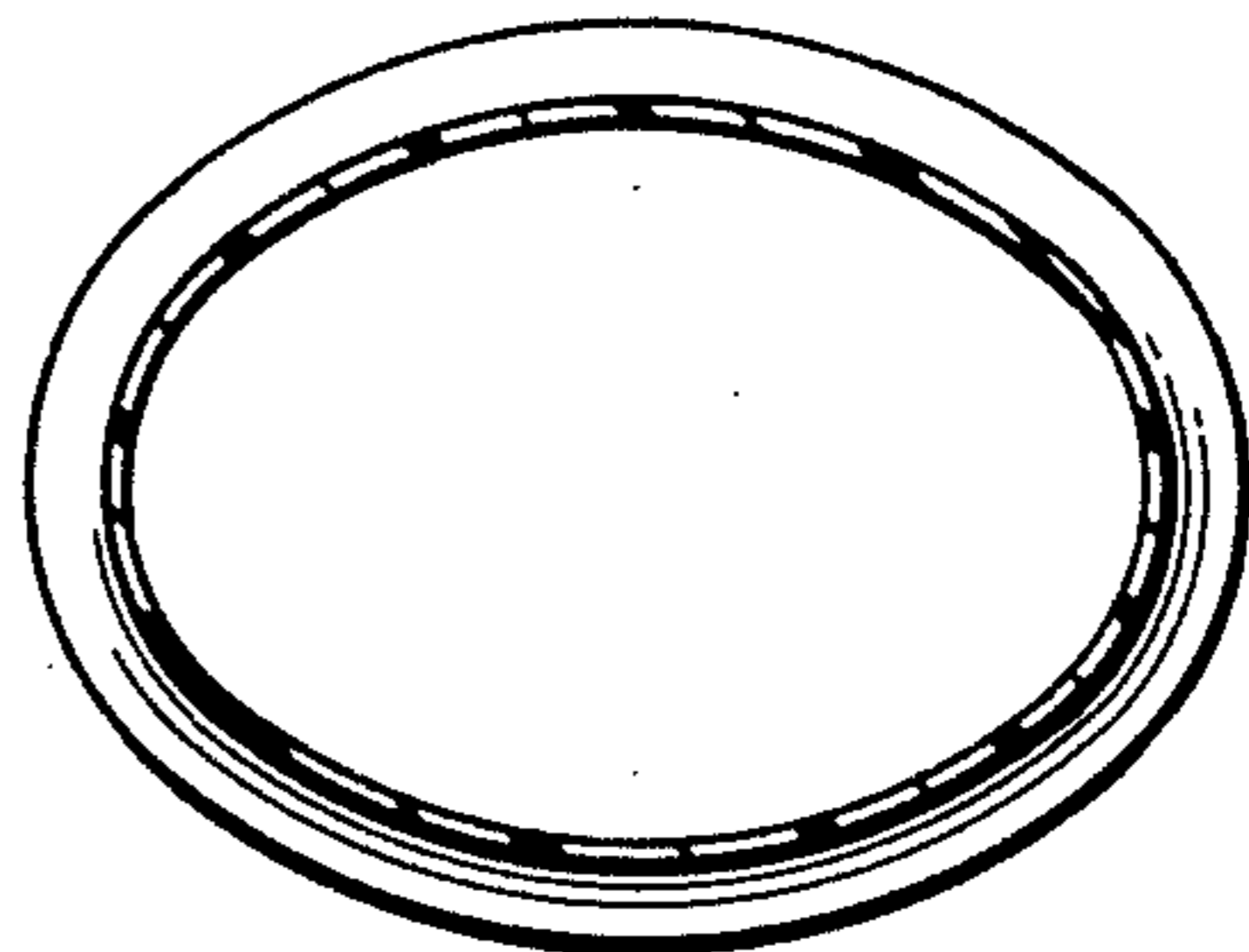

FIG. 6