

[54] TABLE

[76] Inventor: Steven Douglas Gageby, 12 Hay Camp Rd., North Oaks, Minn. 55110

[\*\*] Term: 14 Years

[21] Appl. No.: 677,604

[22] Filed: Apr. 16, 1976

[51] Int. Cl. .... D6-03

[52] U.S. Cl. .... D6/177

[58] Field of Search ..... D6/27, 175, 177, 178, D6/179

[56] References Cited

U.S. PATENT DOCUMENTS

D. 180,283	5/1957	Hoven et al. ....	D6/177
D. 220,443	4/1971	Beavers .....	D6/177
D. 236,058	7/1975	Kramer .....	D6/177

OTHER PUBLICATIONS

Interiors, Oct. 1973, p. 20, table top left center.

Primary Examiner—Bruce W. Dunkins  
Attorney, Agent, or Firm—Steven Douglas Gageby

[57] CLAIM

The ornamental design for a table, as shown and described.

DESCRIPTION

FIG. 1 is a side elevation view of a table showing my new design, the undisclosed side being substantially identical with the side shown, the recessed areas are shaded for color contrast;

FIG. 2 is an end elevation view thereof, the undisclosed end being substantially identical with the end shown, the recessed areas are shaded for color contrast;

FIG. 3 is a cross-section taken on line 3—3 of FIG. 1, the recessed area is shaded for color contrast;

FIG. 4 is a cross-section taken on line 4—4 of FIG. 2, the recessed areas are shaded for color contrast;

FIG. 5 is a top view of my new design;

FIG. 6 is a second embodiment of FIG. 5;

FIG. 7 is a third embodiment of FIG. 5; and

FIG. 8 is a perspective view of my new design; the recessed areas are shaded for color contrast.

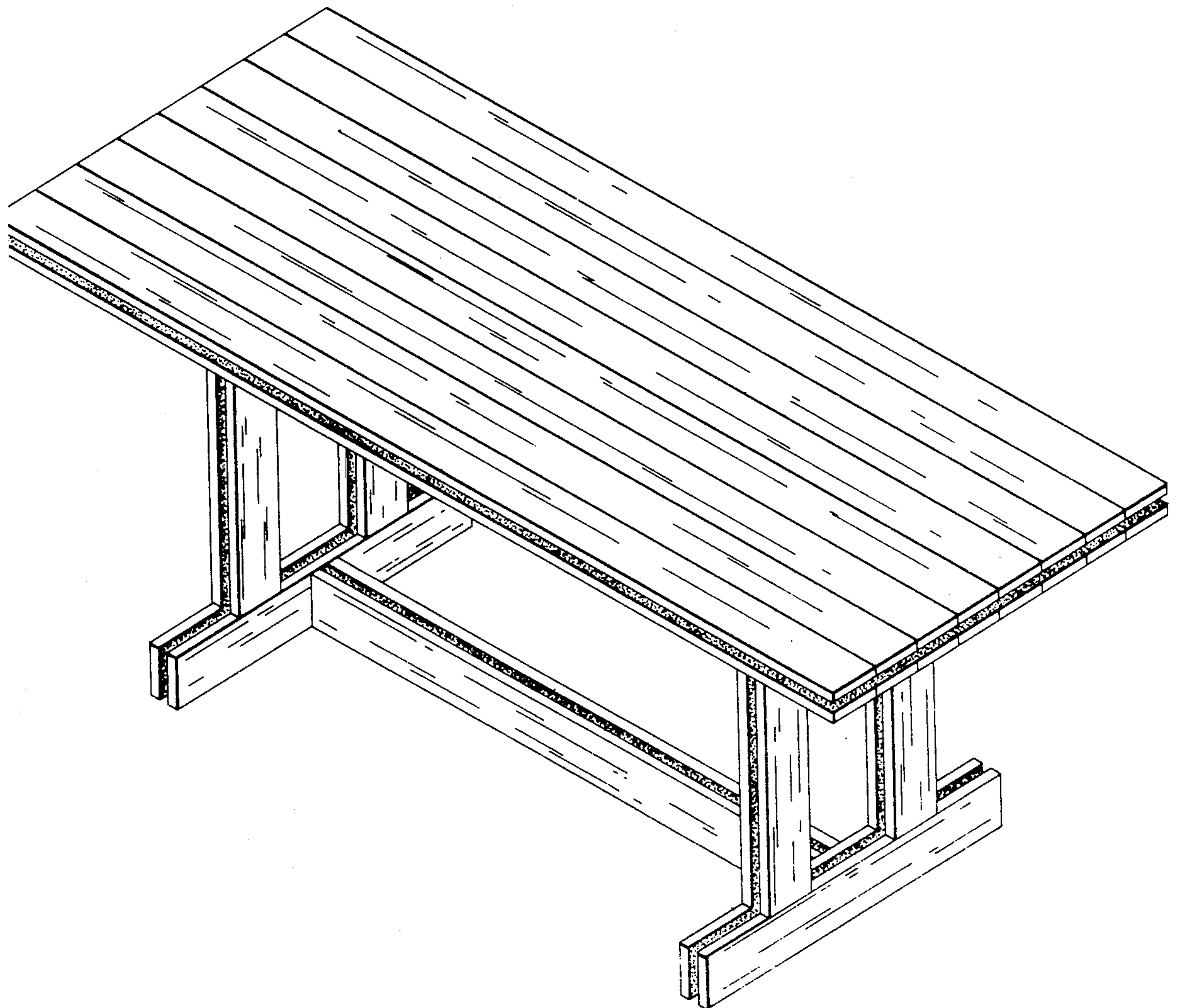

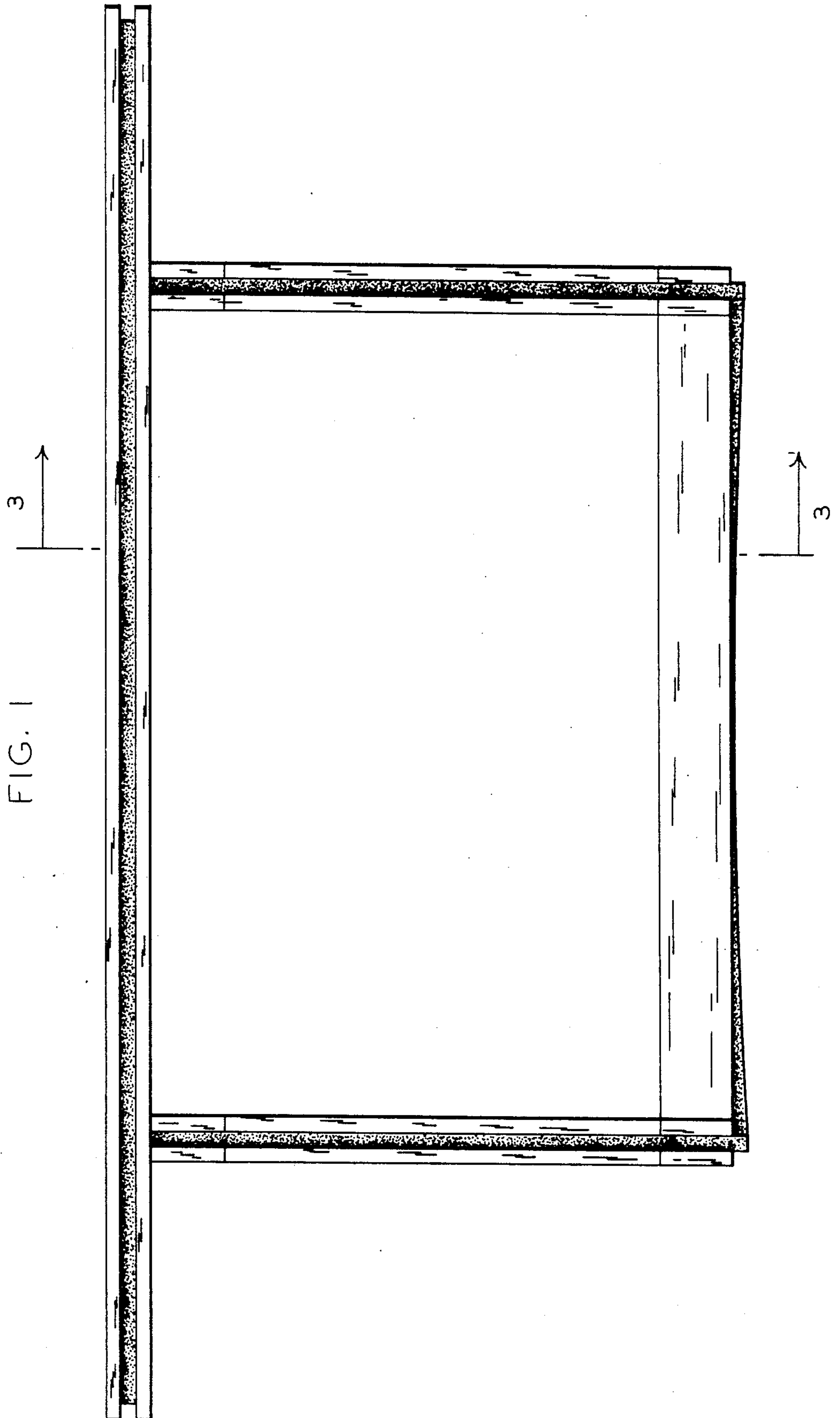

FIG. 3

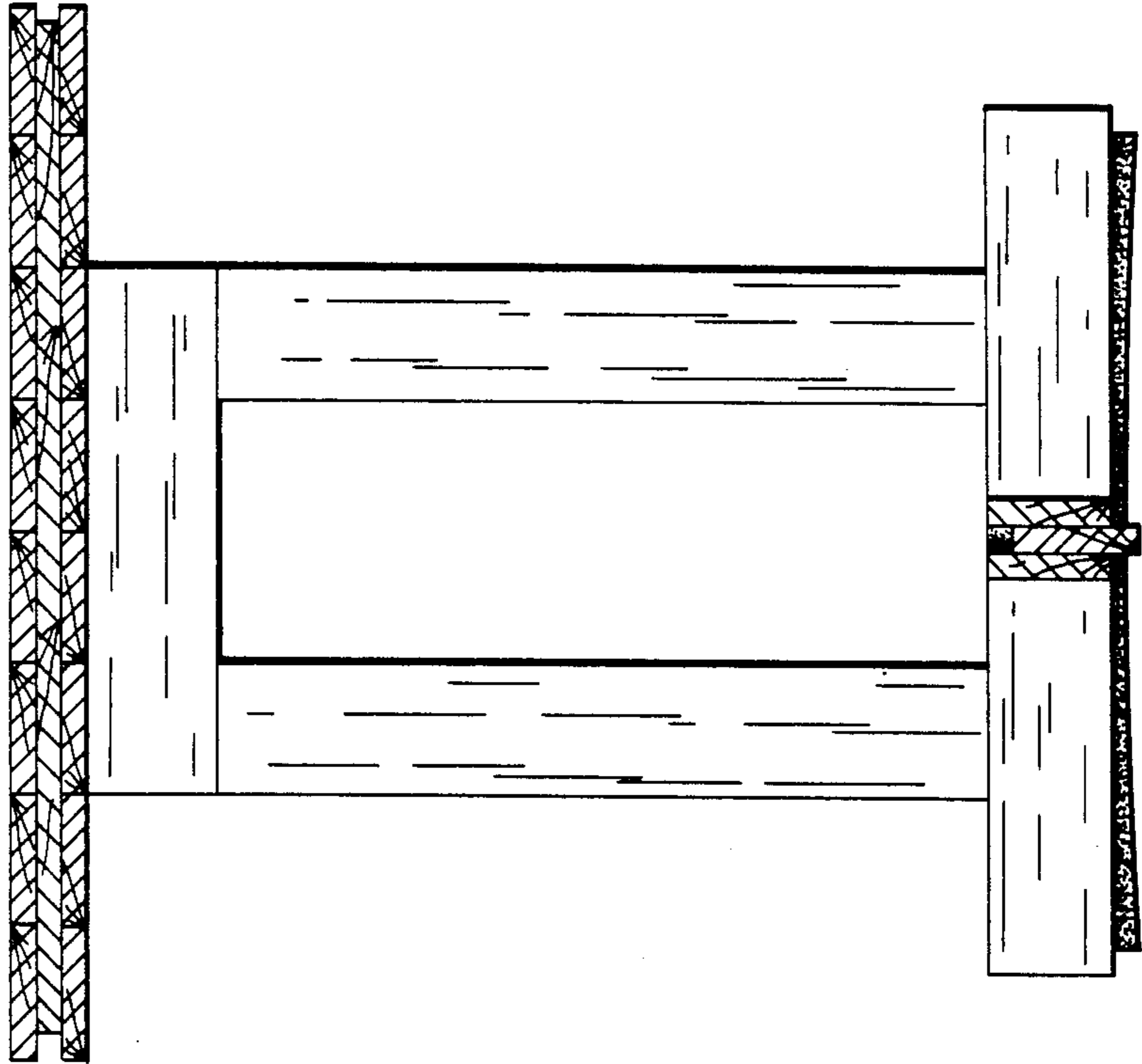
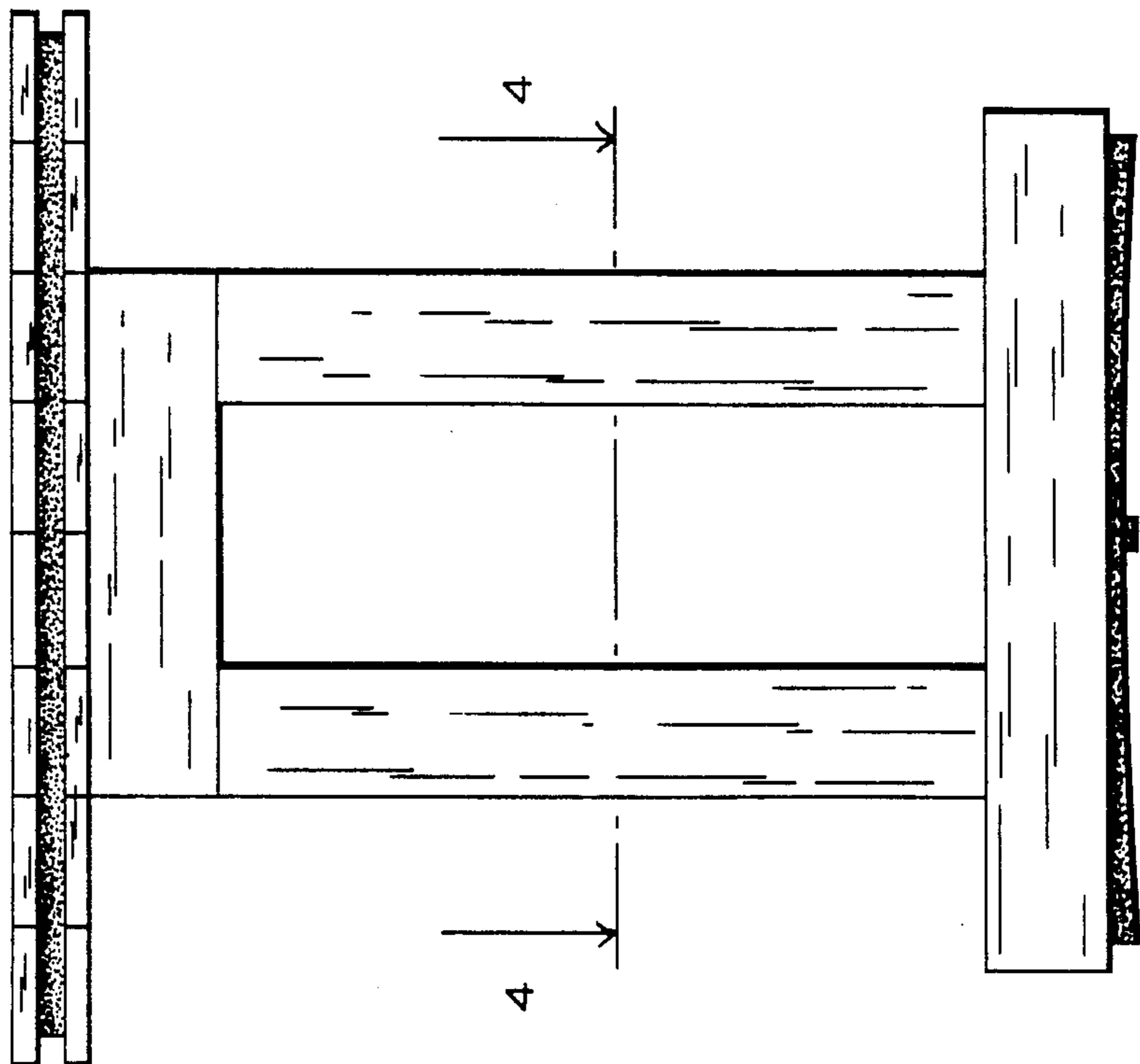

FIG. 2



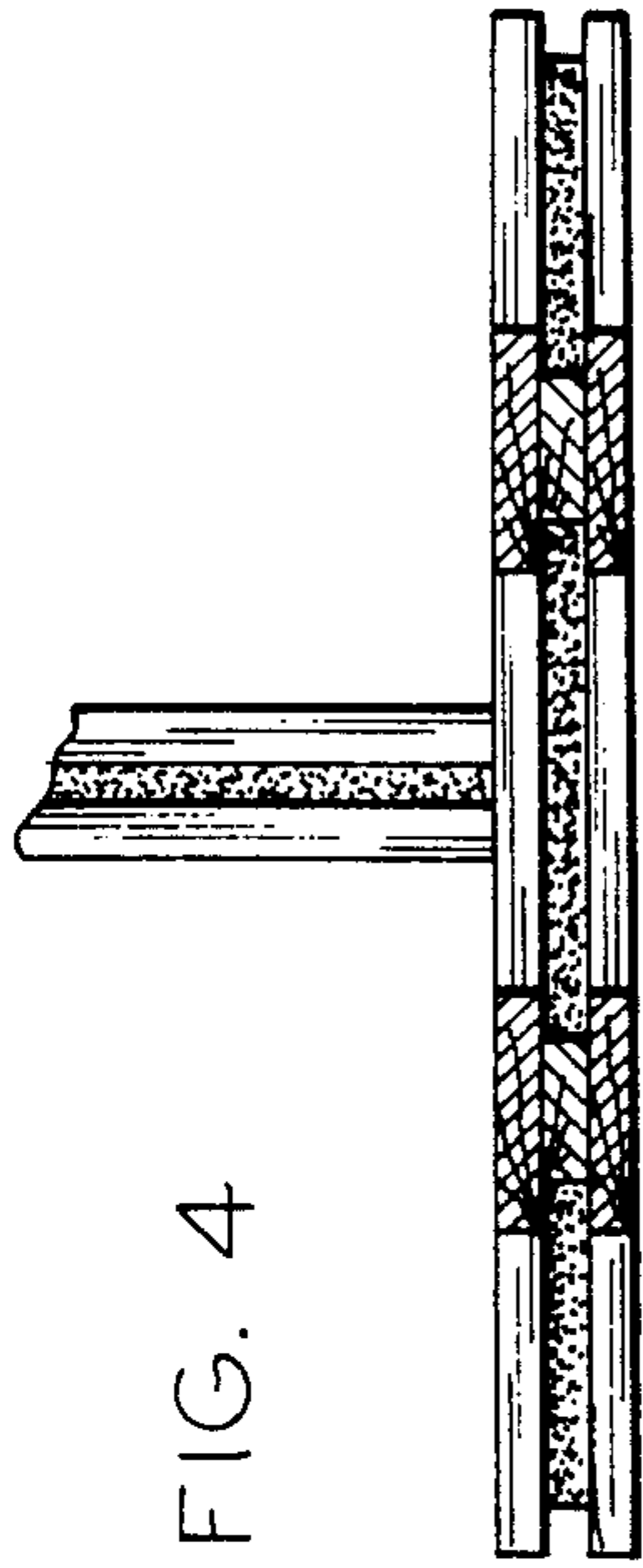

FIG. 4

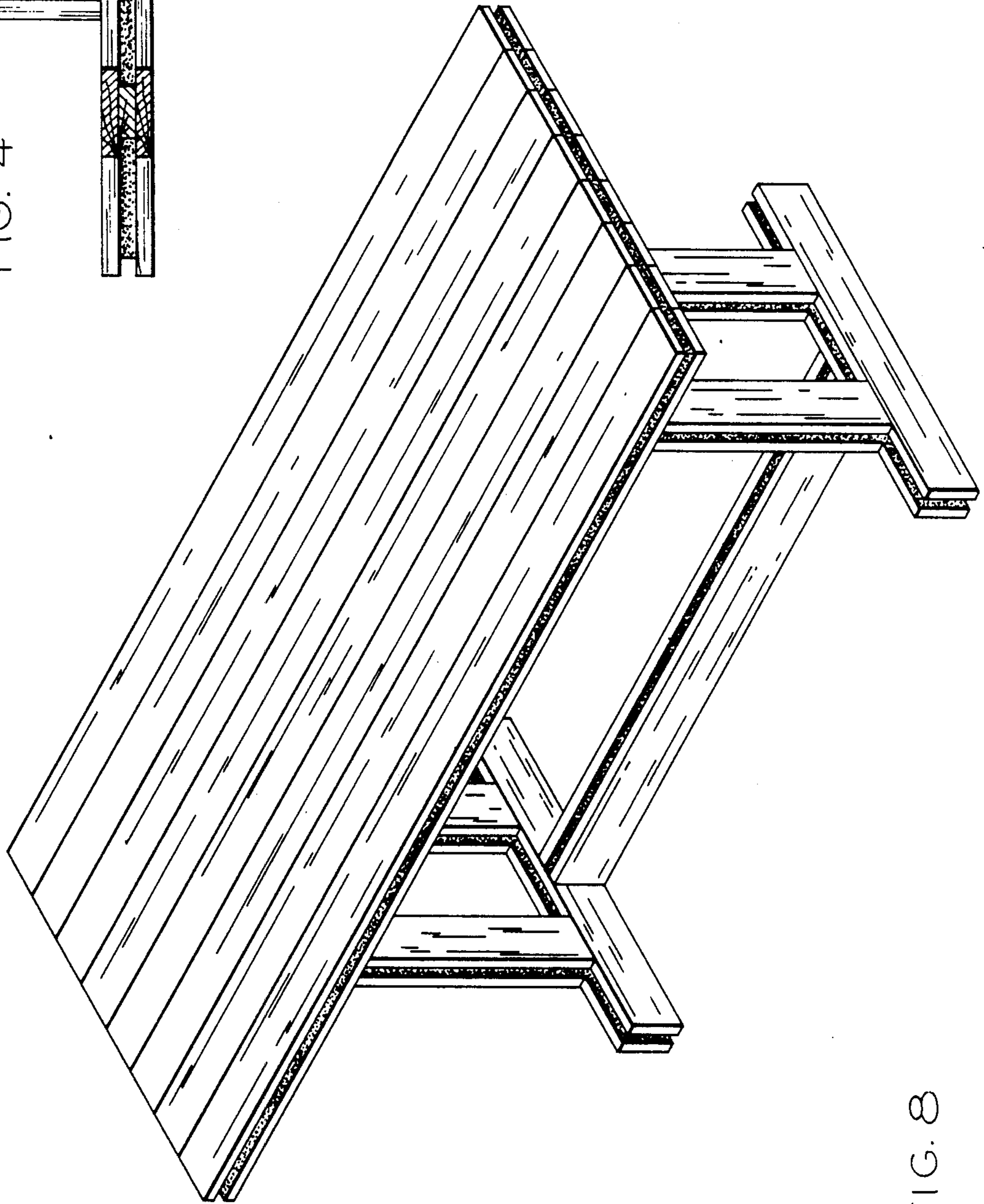

FIG. 8

FIG. 7

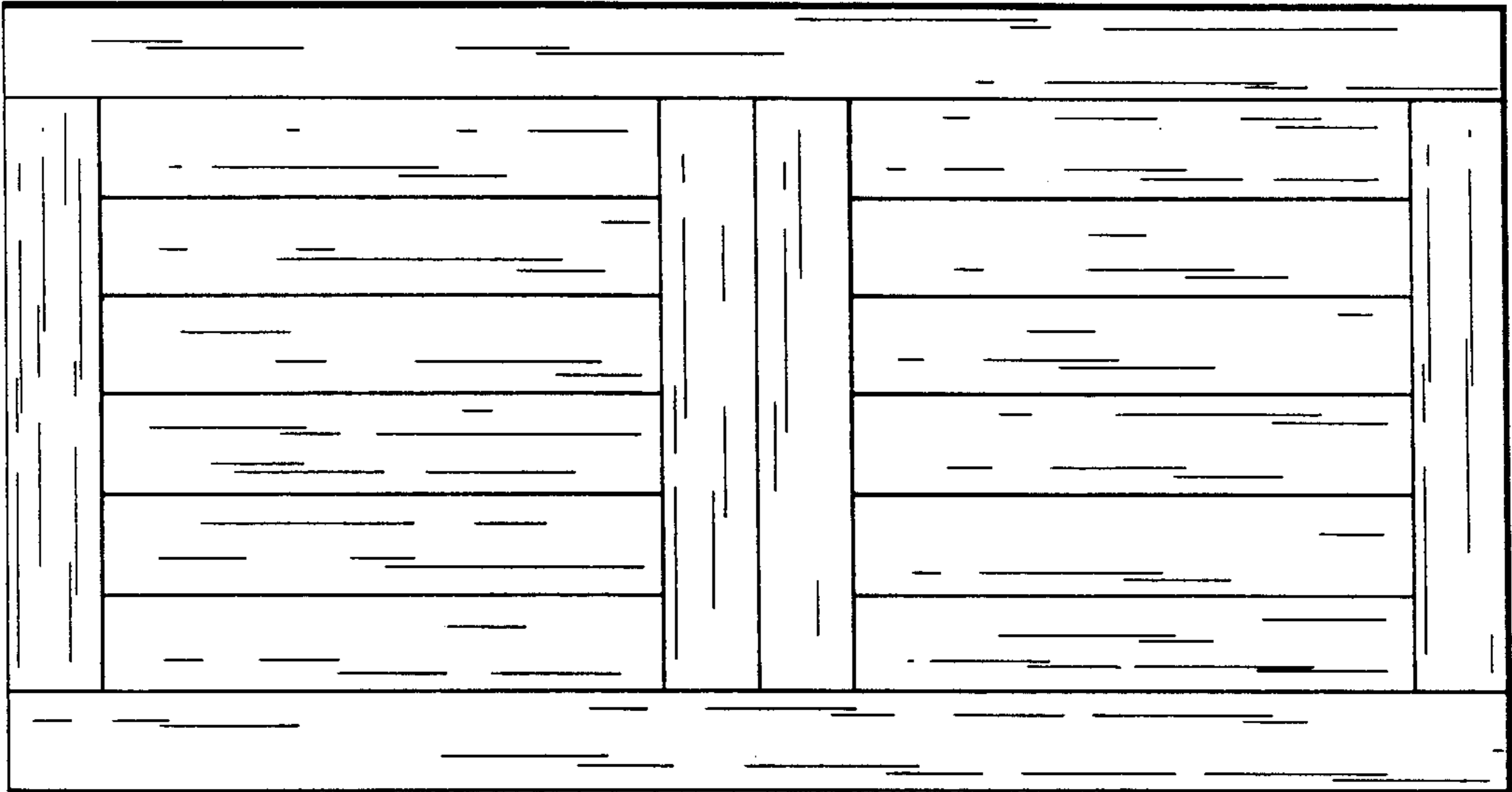

FIG. 6

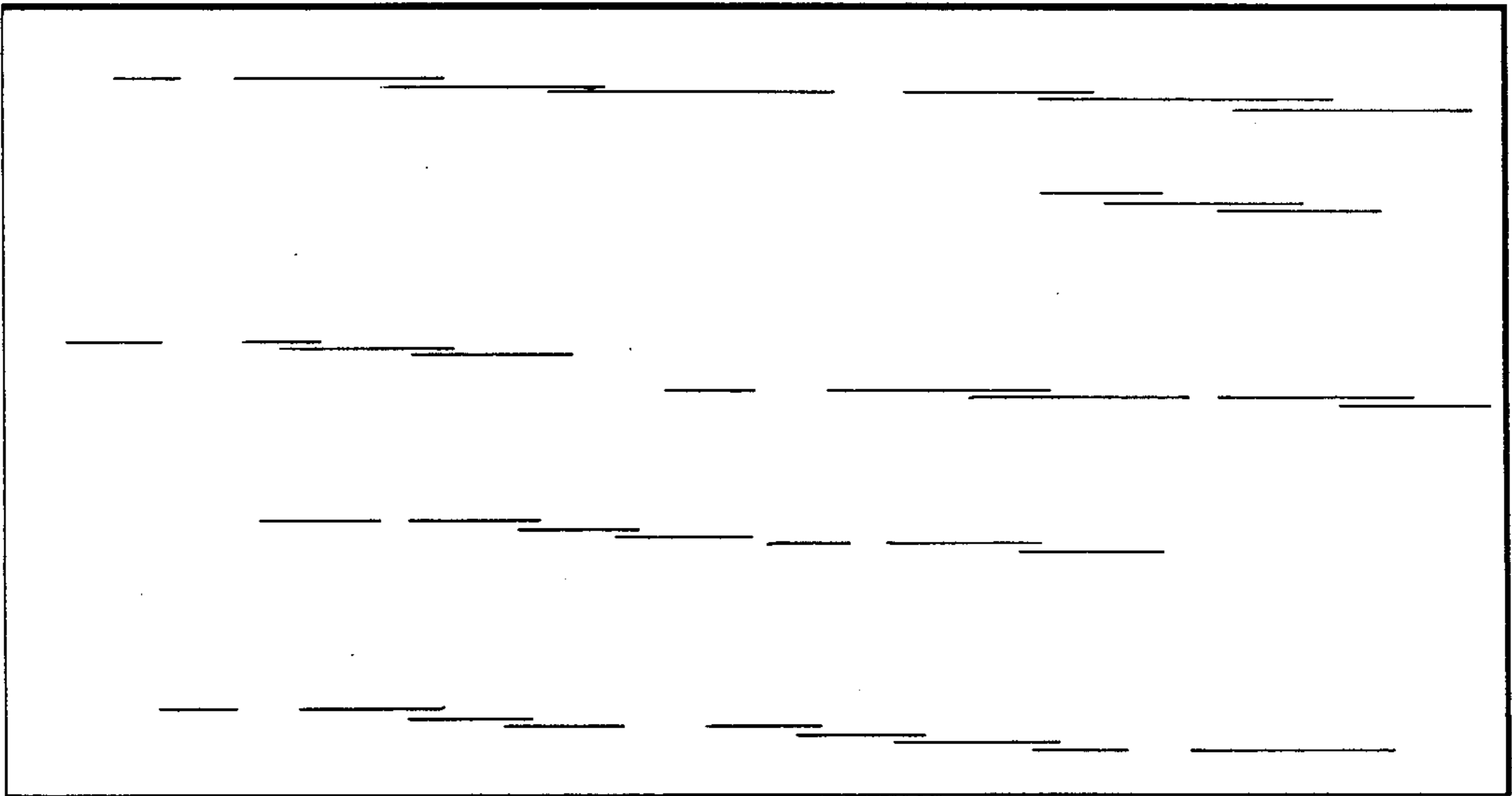

FIG. 5

