

[54] STOVE

[76] Inventors: William C. Walker, 3675 S. 2300 East, Salt Lake City, Utah 84109; William D. Atkinson, 12245 S. 2240 West, Riverton, Utah 84065

[**] Term: 14 Years

[21] Appl. No.: 757,845

[22] Filed: Jan. 10, 1977

[51] Int. Cl. D23-03
[52] U.S. Cl. D23/97
[58] Field of Search D23/72, 86, 89, 92, D23/93, 94, 97, 105, 107, 108, 127, 128; D7/112, 113, 114; 126/4, 6, 58, 59, 60, 62, 65, 120, 121, 123, 126, 138, 190, 200, 211, 217

[56]

References Cited

U.S. PATENT DOCUMENTS

D. 254	12/1849	Lamb et al.	D7/113
D. 91,715	3/1934	Kahn	D23/92
D. 237,798	11/1975	Fisher	D23/72
4,027,649	6/1977	Jackson	126/4

Primary Examiner—Wallace R. Burke
Assistant Examiner—Catherine Kemper
Attorney, Agent, or Firm—B. Deon Criddle

[57]

CLAIM

The ornamental design for a stove, substantially as shown and described.

DESCRIPTION

FIG. 1 is a front perspective view of a stove, showing our new design;
FIG. 2 is a front elevation view.
FIG. 3 is an elevation view of one side, the opposite side being a mirror image thereof.
FIG. 4 is a rear elevation view.
FIG. 5 is a top plan view.
FIG. 6 is a bottom plan view.

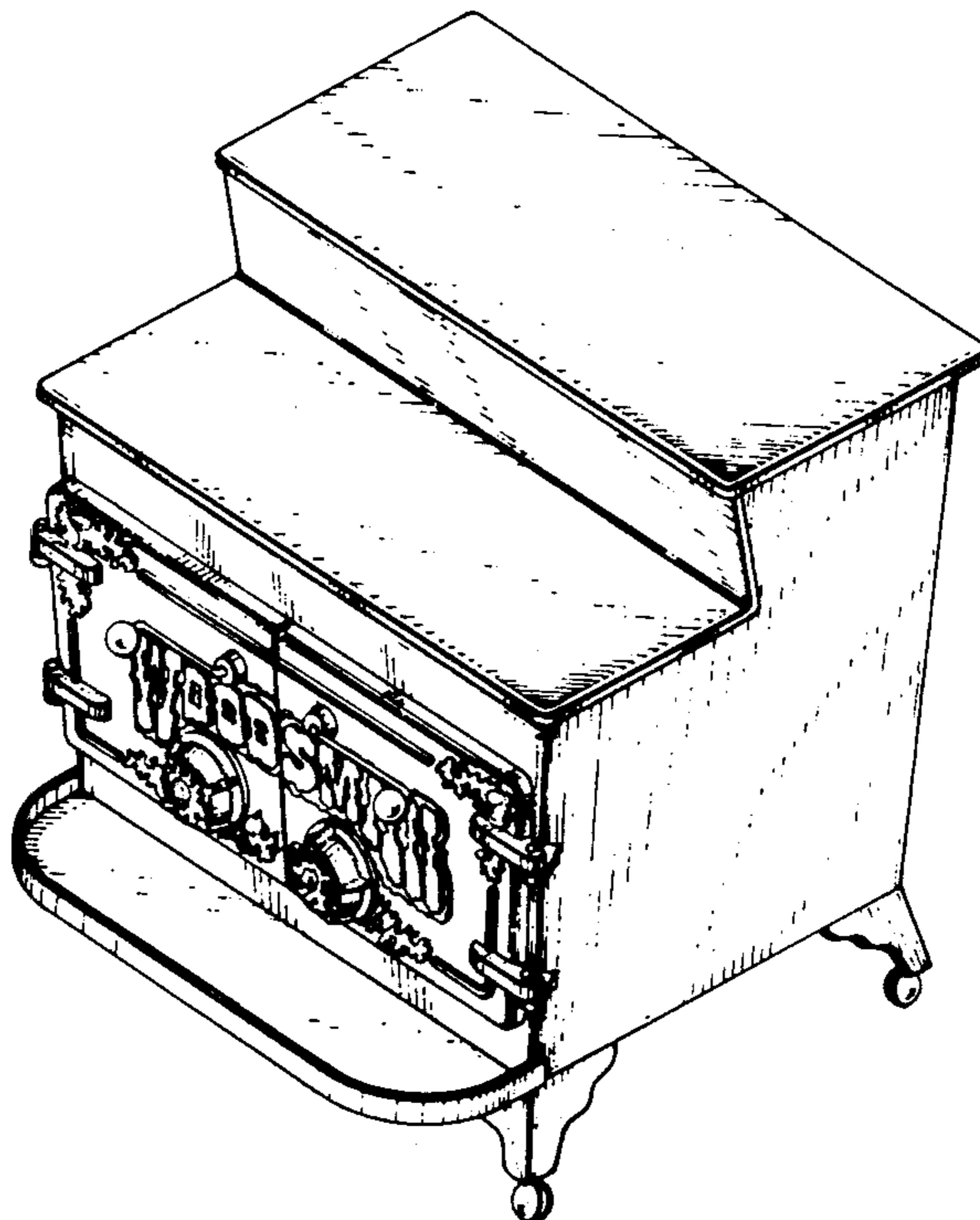

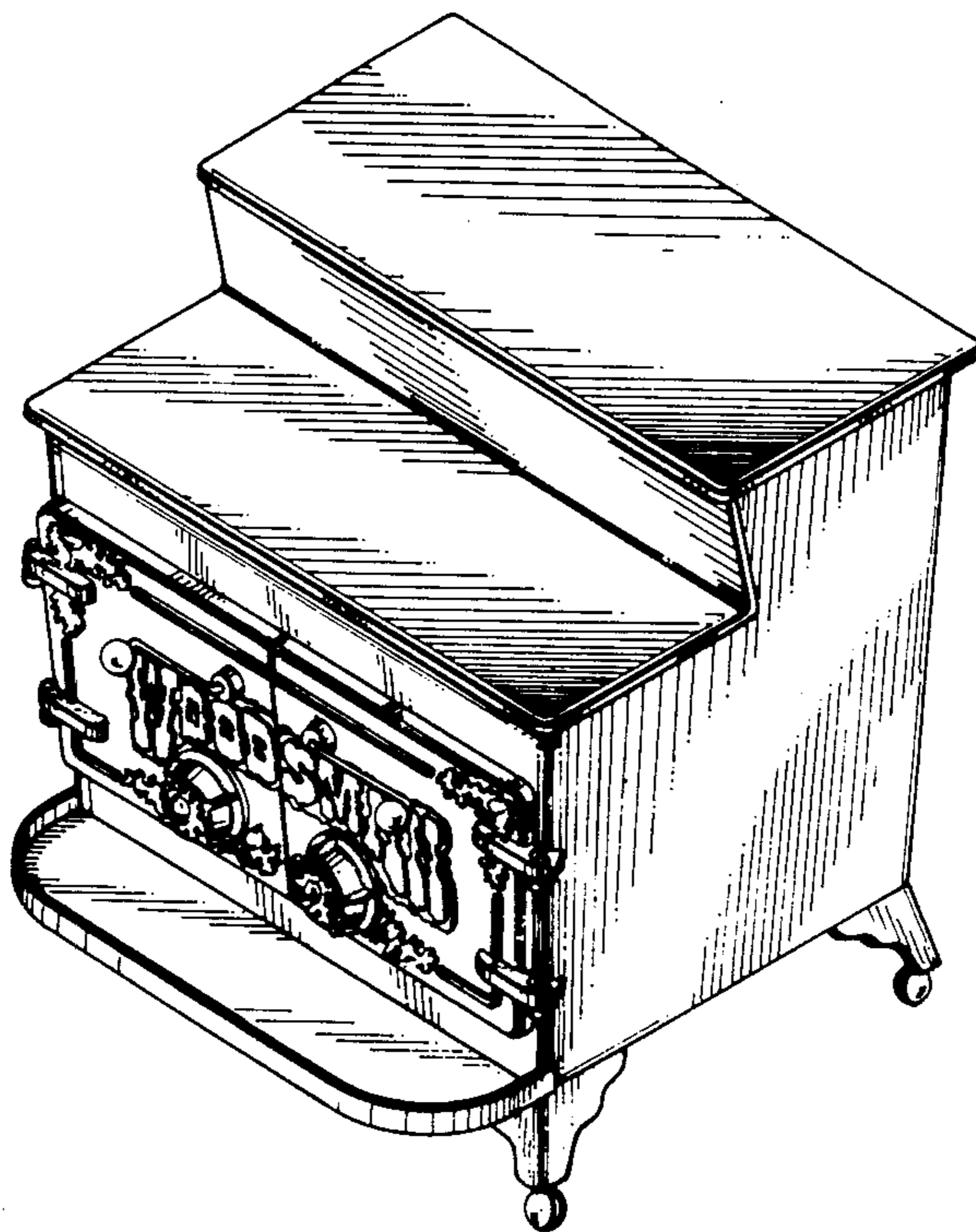

FIG. 1

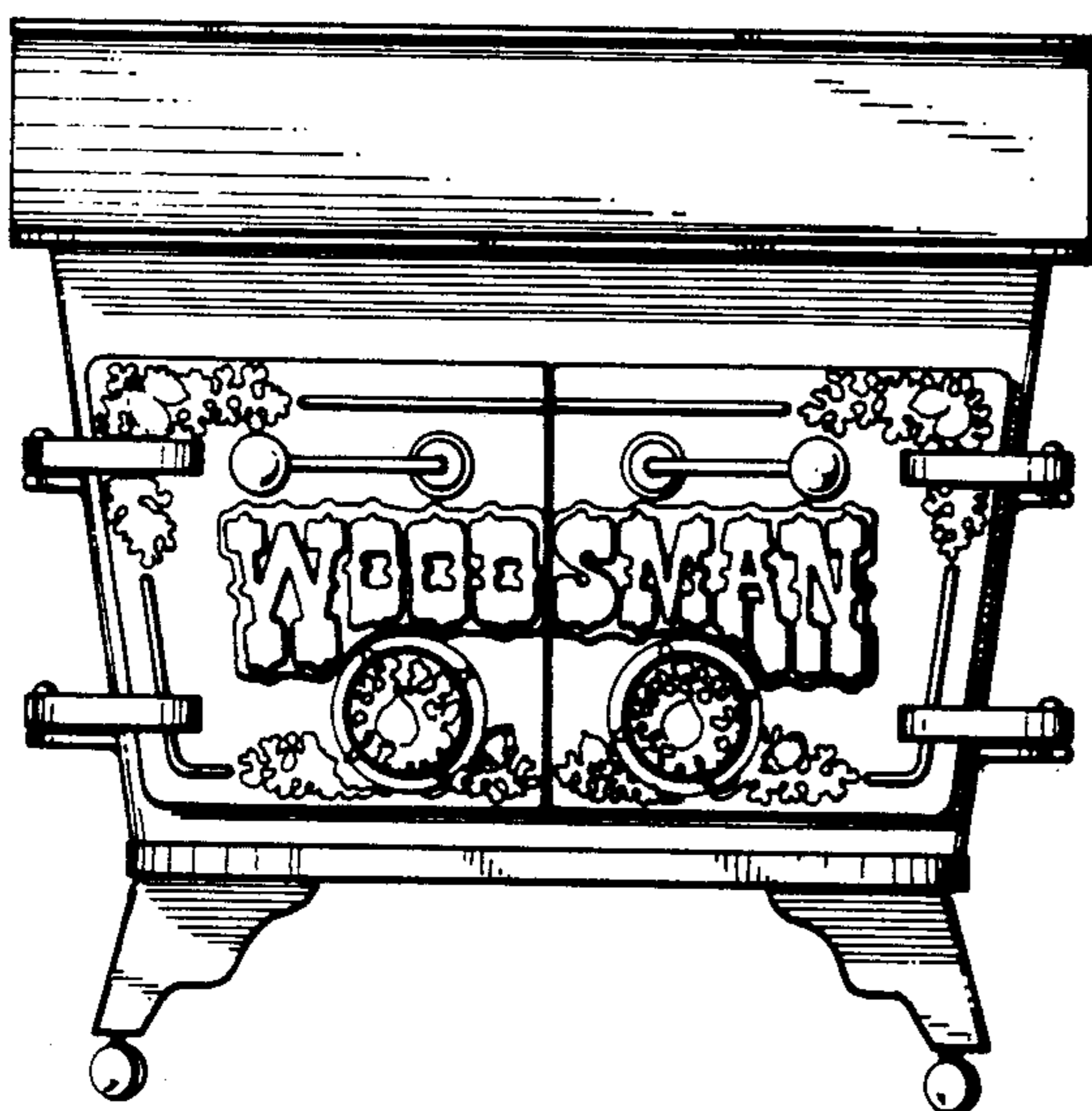

FIG. 2

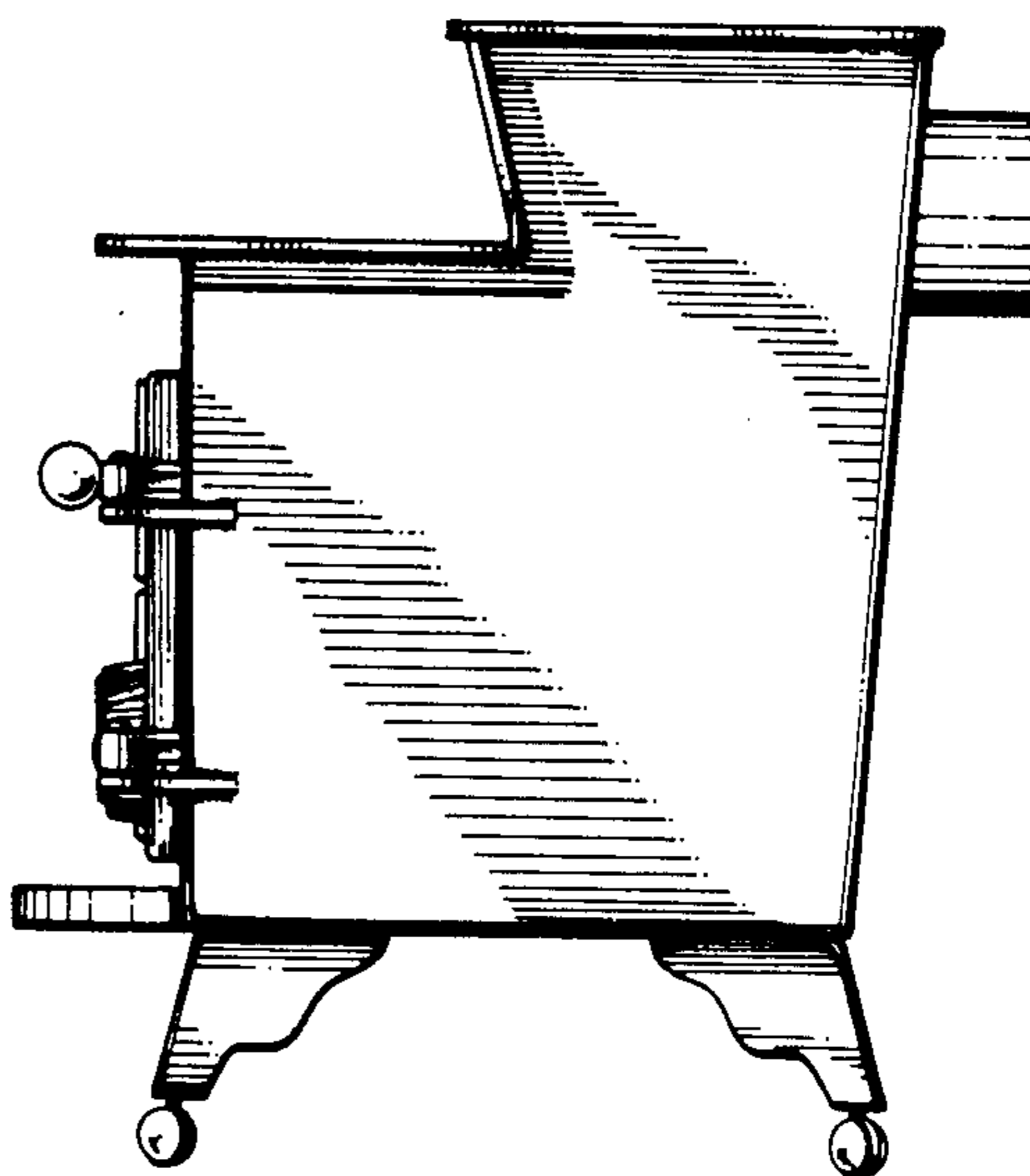

FIG. 3

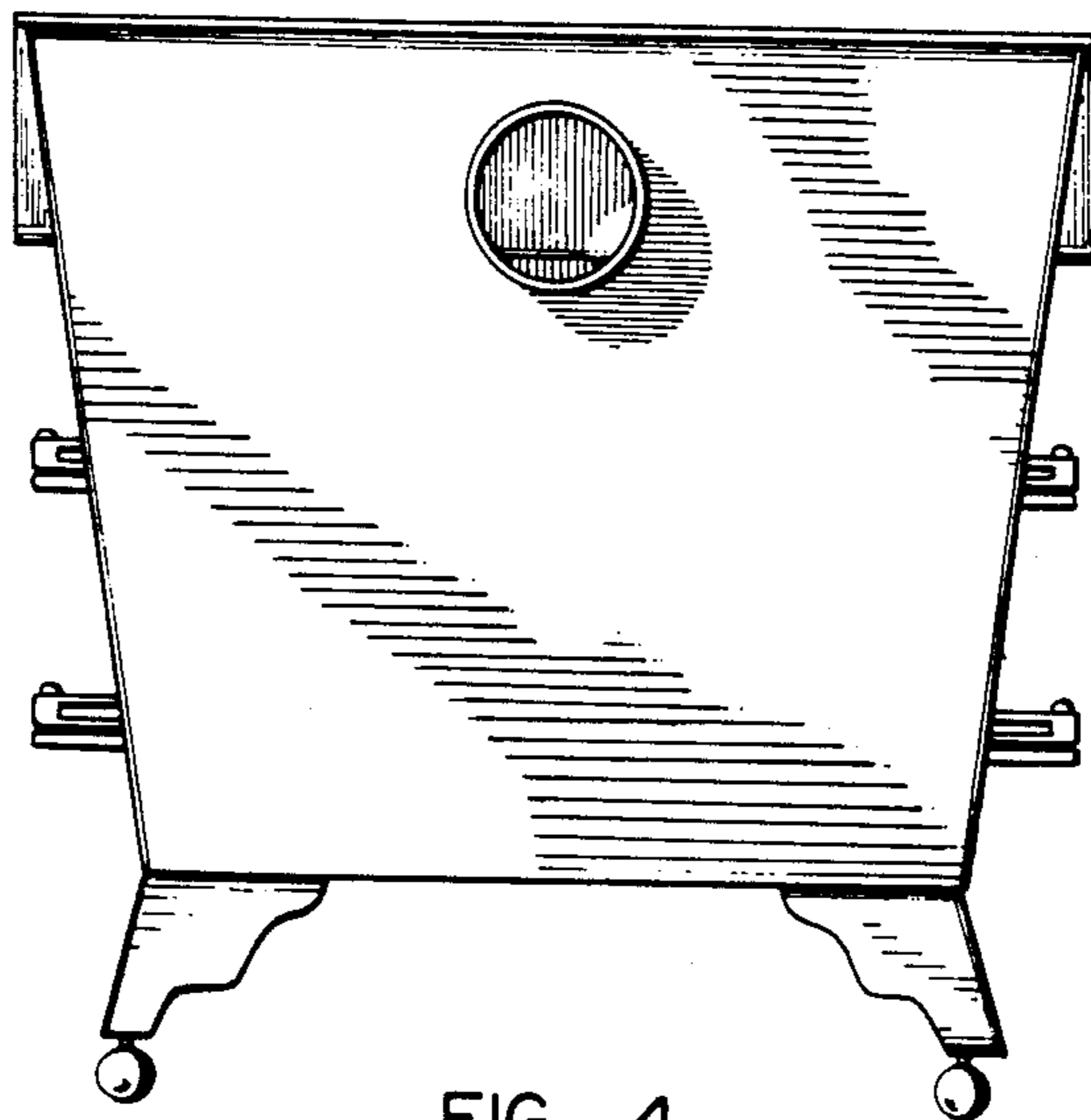

FIG. 4

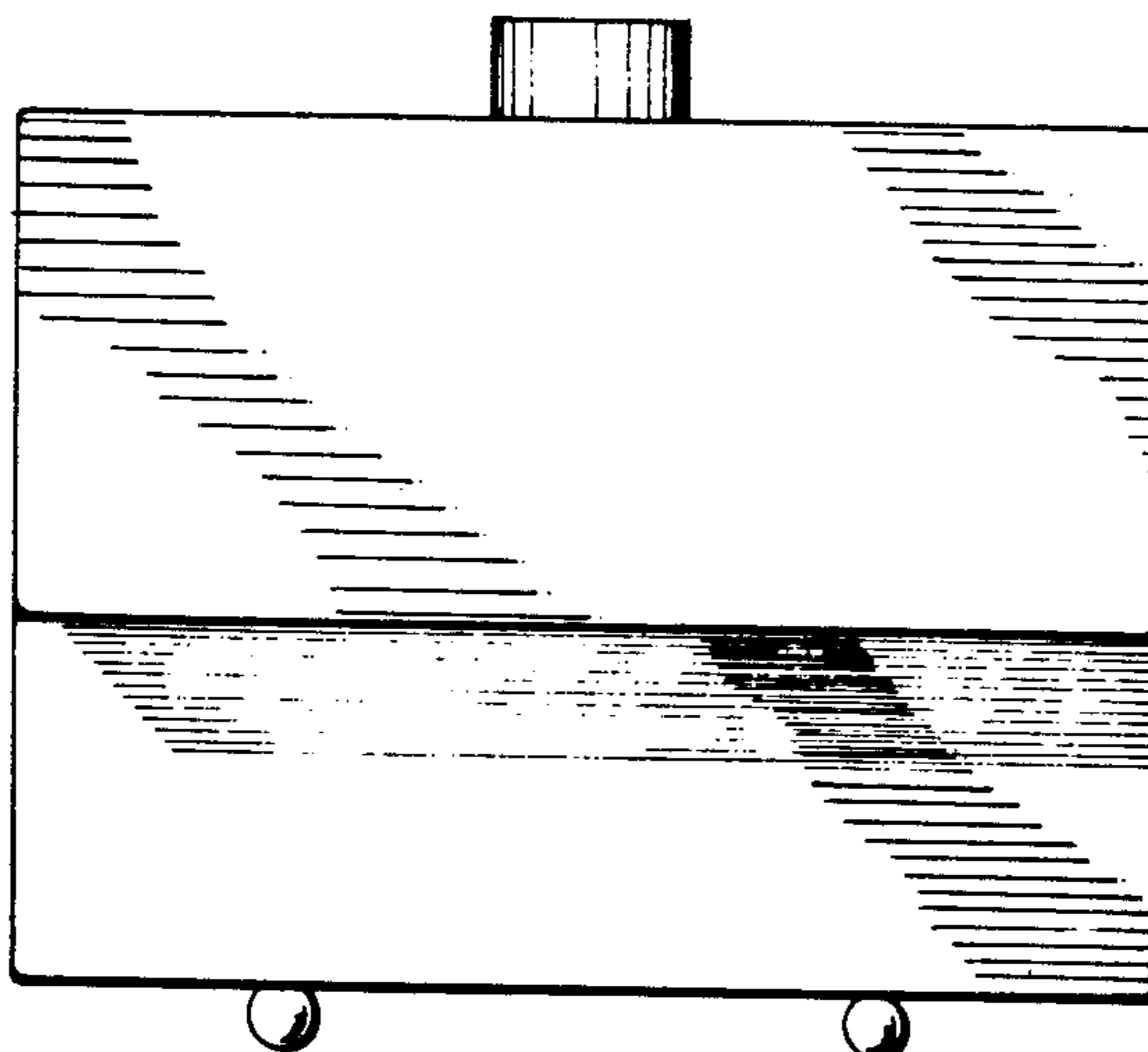

FIG. 5

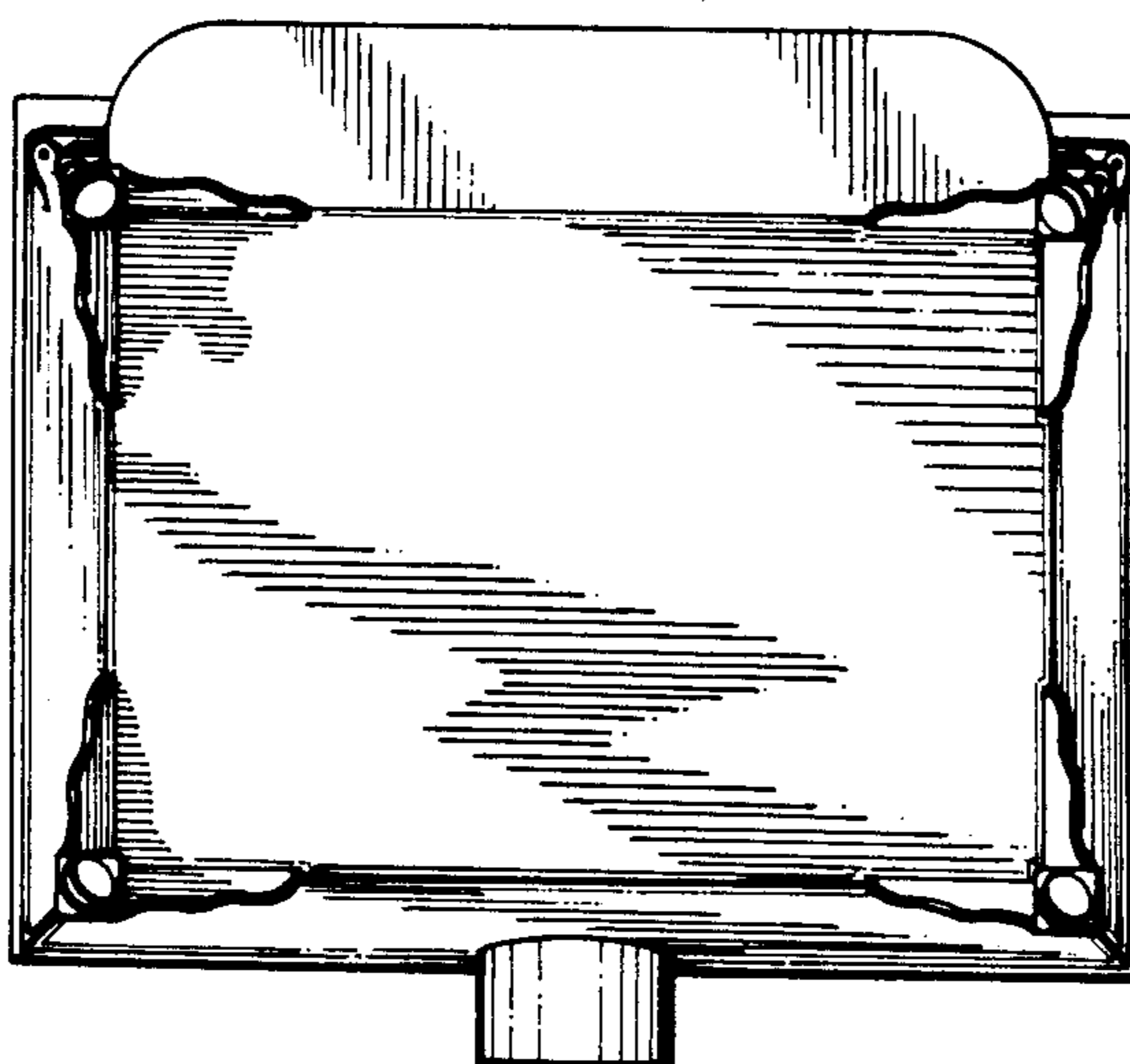

FIG. 6