

[54] PUSH SWEEPER

[75] Inventor: Eugene L. Bothun, Berthoud, Colo.

[73] Assignee: Clarke-Gravelly Corporation,
Muskegon, Mich.

[**] Term: 14 Years

[21] Appl. No.: 655,007

[22] Filed: Feb. 4, 1976

[51] Int. Cl. D15-05

[52] U.S. Cl. D15/50

[58] Field of Search D15/34, 48, 49, 50,
D15/51; 15/49 R, 50 R, 349, 340

[56]

References Cited

U.S. PATENT DOCUMENTS

2,782,434	2/1957	Parker et al.	15/49 R
3,201,819	8/1965	Wilgus	15/349
3,570,040	3/1971	Wada	15/349

Primary Examiner—Wallace R. Burke
Assistant Examiner—Catherine Kemper
Attorney, Agent, or Firm—Peter P. Price

[57]

CLAIM

The ornamental design for a push sweeper, as shown.

DESCRIPTION

FIG. 1 is a perspective view of a push sweeper, showing my new design;
FIG. 2 is a right side elevational view thereof;
FIG. 3 is a left side elevational view thereof;
FIG. 4 is a plan view thereof;
FIG. 5 is a rear elevational view thereof;
FIG. 6 is a front elevational view thereof; and
FIG. 7 is a bottom plan view thereof.

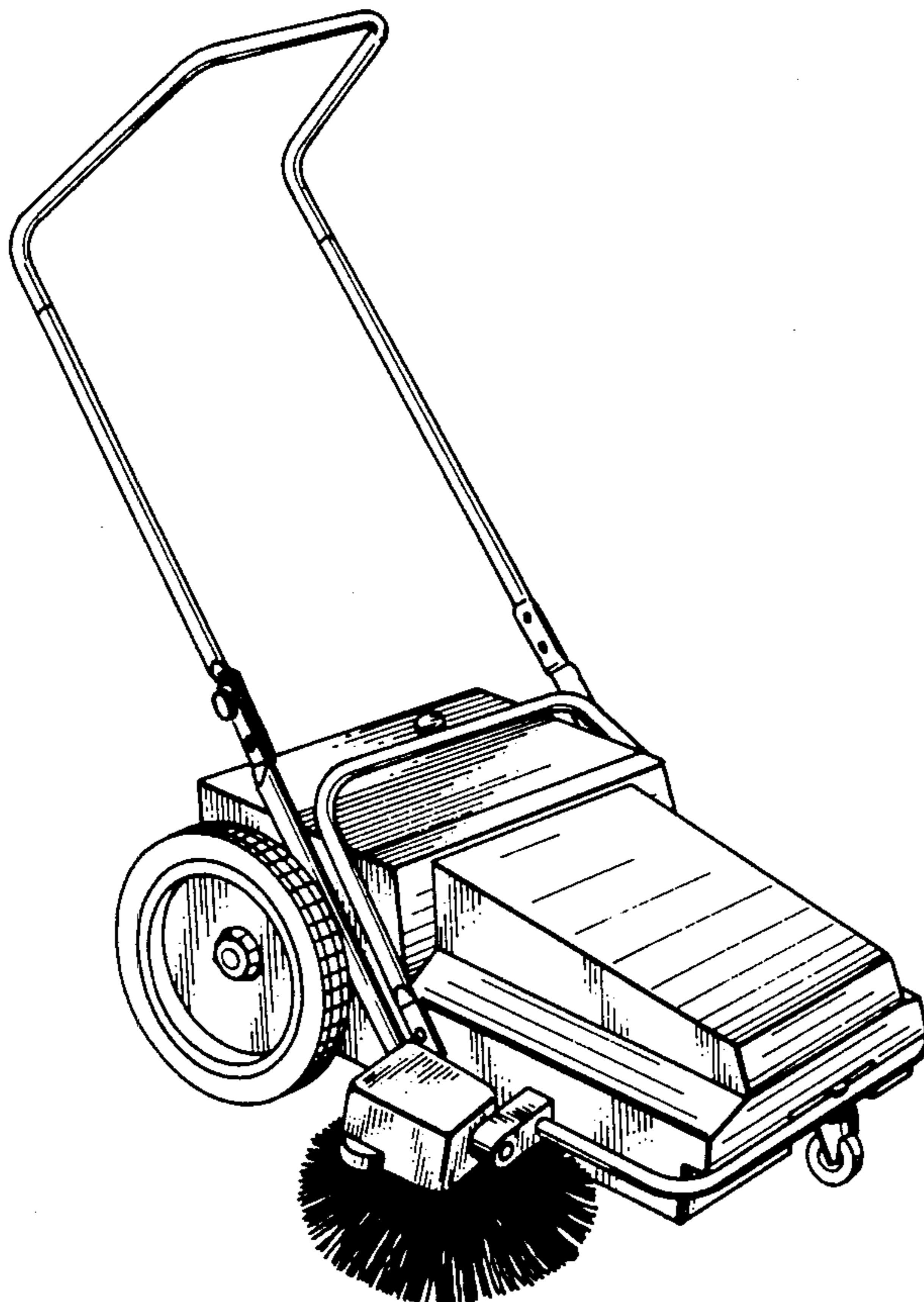

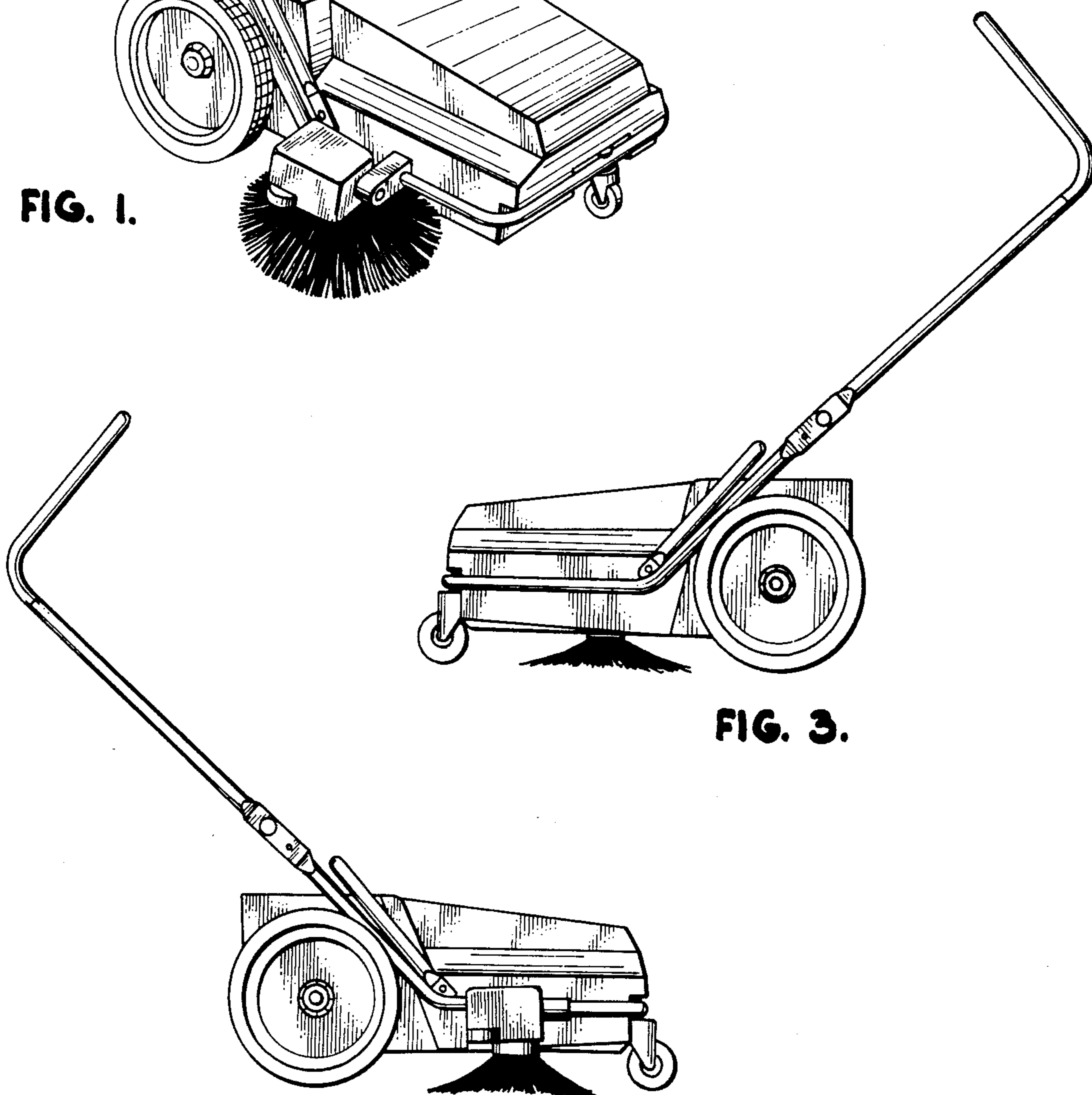
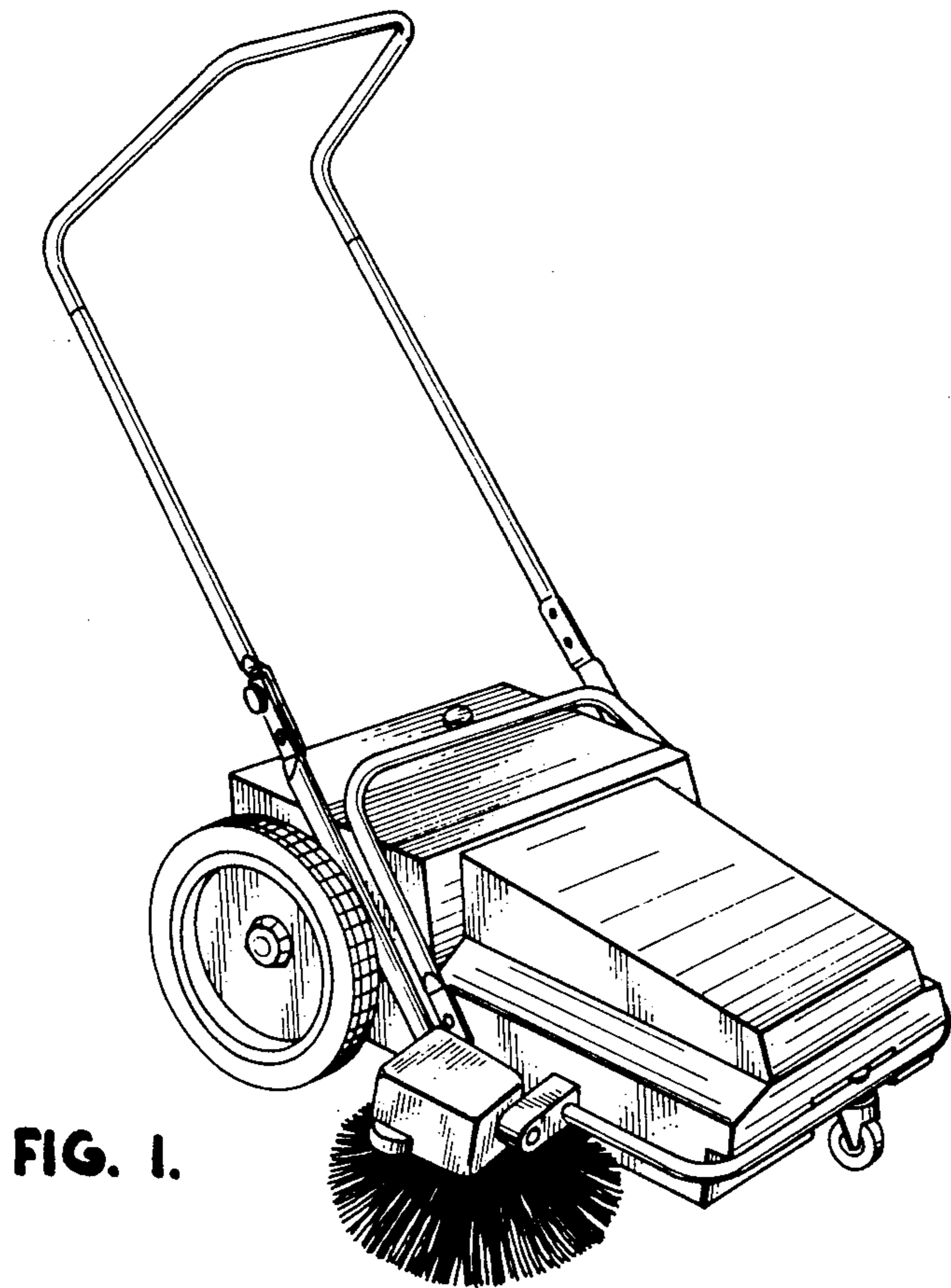

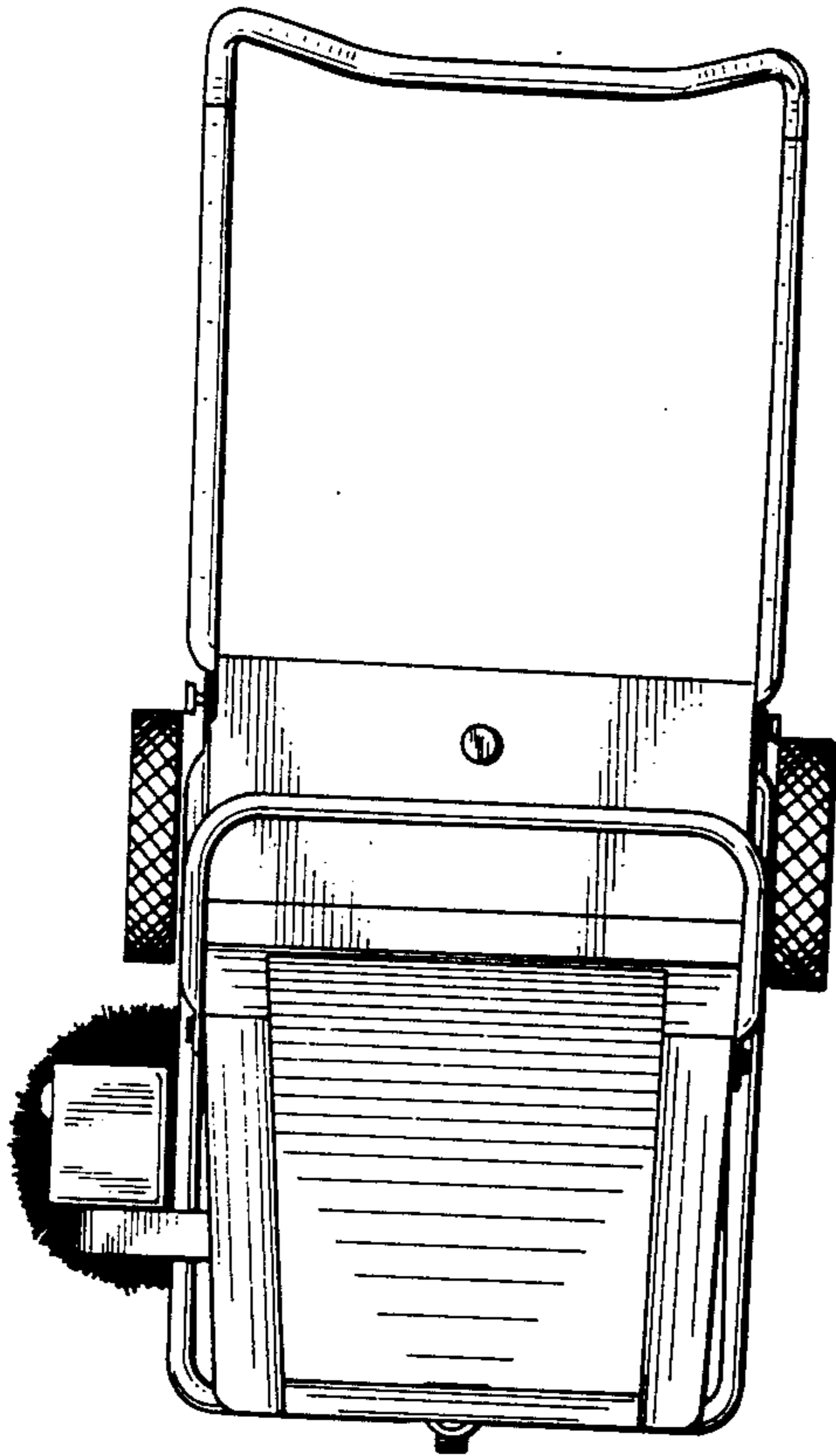

FIG. 4.

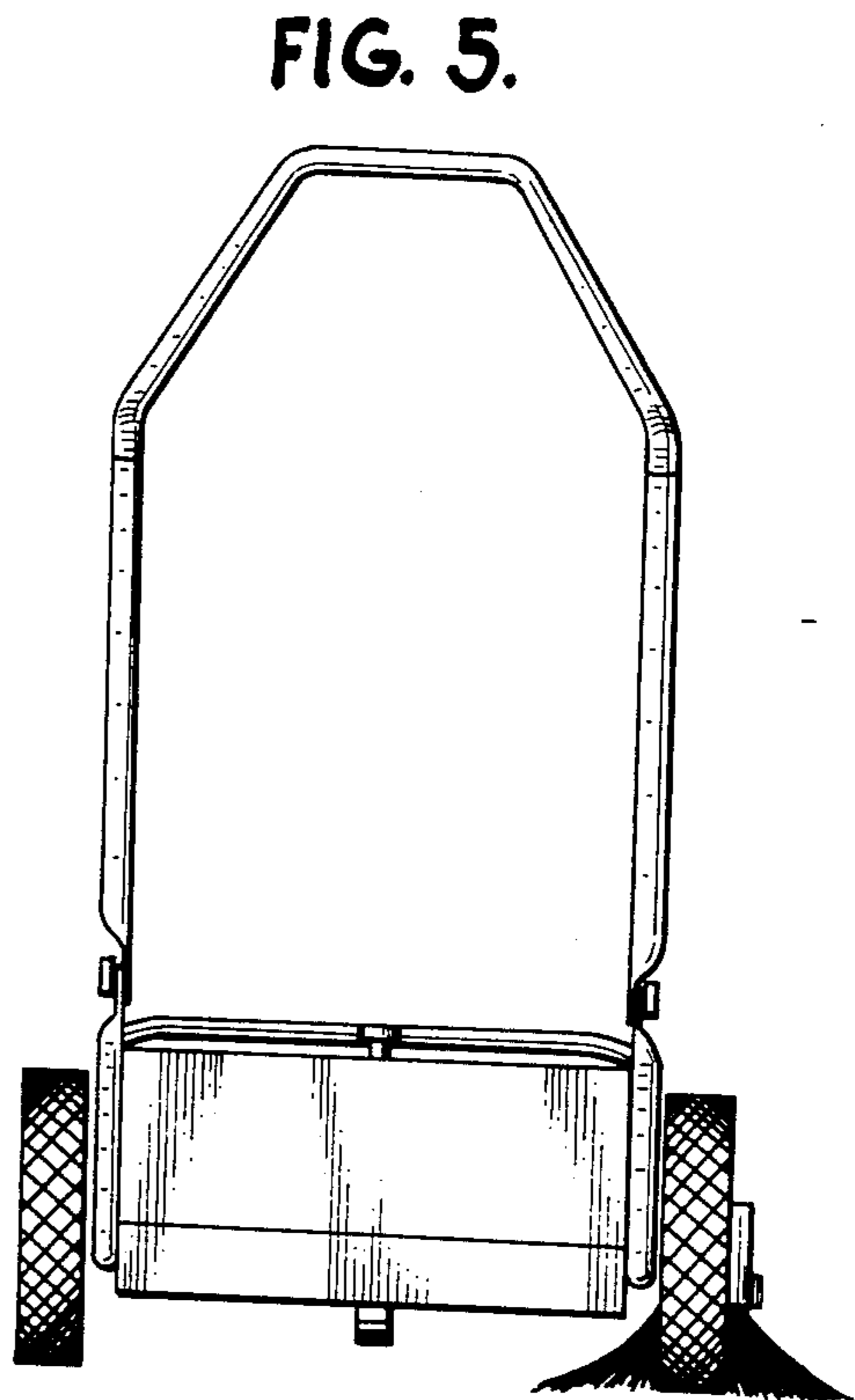

FIG. 5.

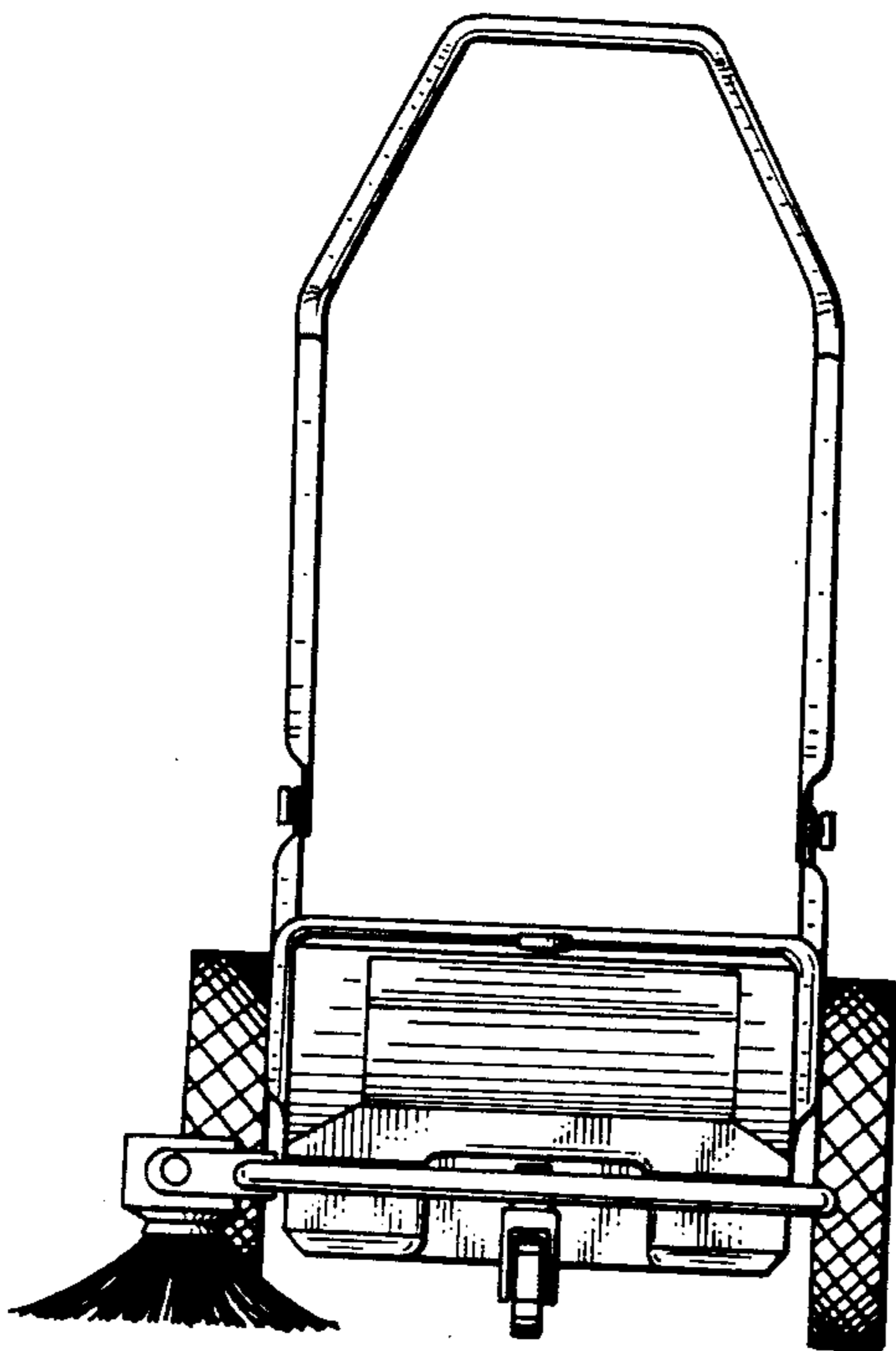

FIG. 6.

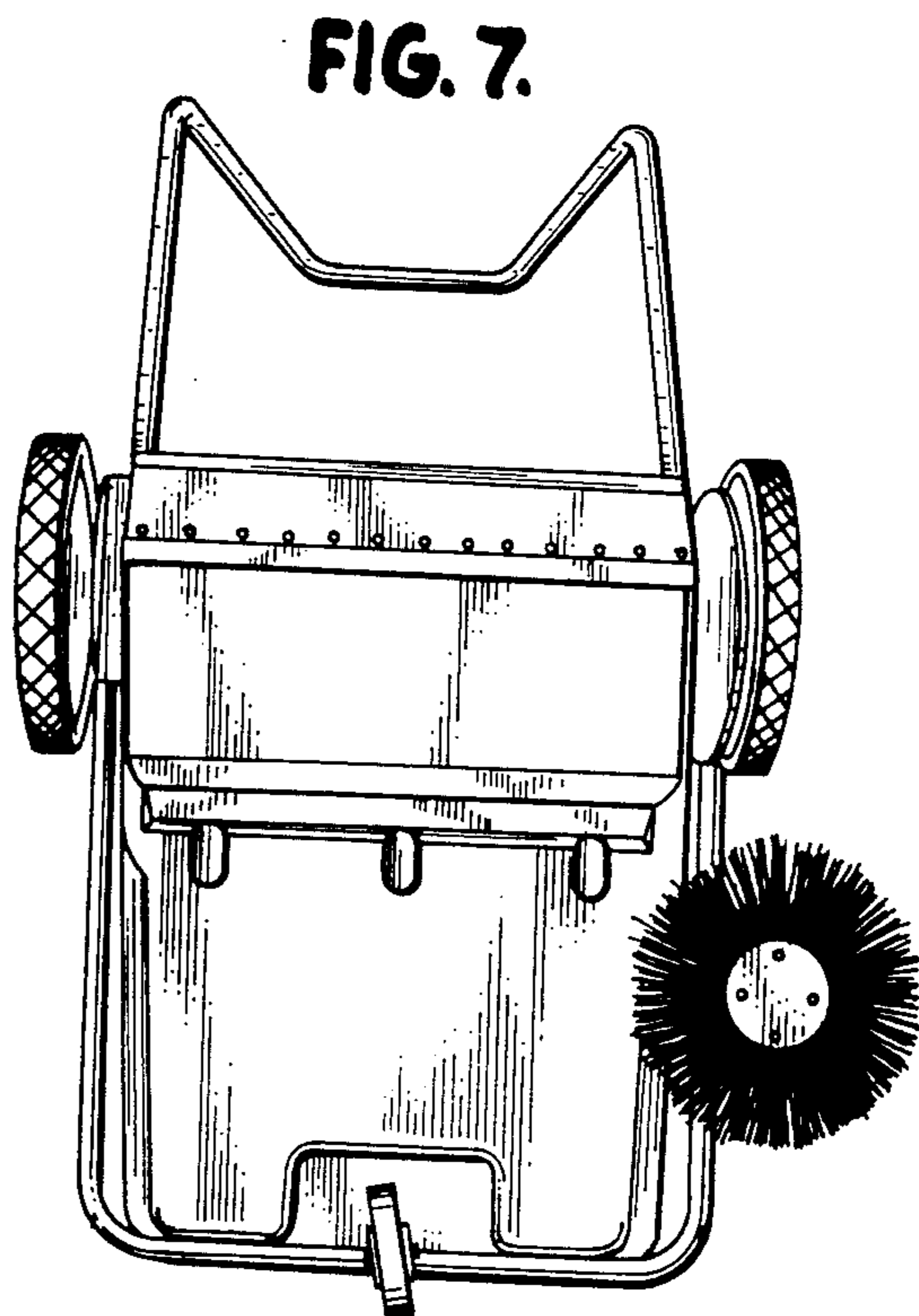

FIG. 7.