

[54] BEARING COVER PLATE FOR A VERTICAL BAR CAM LOCK

[75] Inventor: John V. Pastva, Jr., Parma Heights, Ohio

[73] Assignee: The Eastern Company, Naugatuck, Conn.

[**] Term: 14 Years

[21] Appl. No.: 694,659

[22] Filed: Jun. 10, 1976

[51] Int. Cl. D8-07

[52] U.S. Cl. D8/346

[58] Field of Search D8/343, 346, 339, 341; 292/241, 218, 145, DIG. 32

[56] References Cited

U.S. PATENT DOCUMENTS

1,140,517	5/1915	Lewis	292/218
2,204,753	6/1940	Dwyer	292/218
2,625,421	1/1953	Haseltine	292/218
3,572,794	3/1971	Pastva	292/218
3,695,661	10/1972	Pastva	292/DIG. 32
3,737,183	6/1973	Pastva, Jr.	292/218
3,756,671	9/1973	White	292/218
3,912,312	10/1975	Cerutti	292/DIG. 32
4,014,138	3/1977	White	292/218

FOREIGN PATENT DOCUMENTS

7,847 of 1894 United Kingdom 292/145

Primary Examiner—Wallace R. Burke

Assistant Examiner—James M. Gandy

Attorney, Agent, or Firm—James T. Hoffmann

[57] CLAIM

An ornamental design for bearing cover plate for a vertical bar cam lock, substantially as shown and described.

DESCRIPTION

FIG. 1 is a front perspective view of a bearing cover plate embodying my new design;

FIG. 2 is a front elevational view thereof to an enlarged scale;

FIG. 3 is a side elevational view thereof to an enlarged scale;

FIG. 4 is an end elevational view thereof to an enlarged scale looking from the top as viewed in FIG. 2;

FIG. 5 is an end elevational view thereof to an enlarged scale looking from the bottom as viewed in FIG. 2; and

FIG. 6 is a rear elevational view thereof to an enlarged scale.

The broken line showing the bearing back plate, vertical bar, cam latch and keeper in FIG. 1 is for illustrative purposes only.

The characteristic feature of my design resides in the specific configuration of the sides of the bearing cover plate.

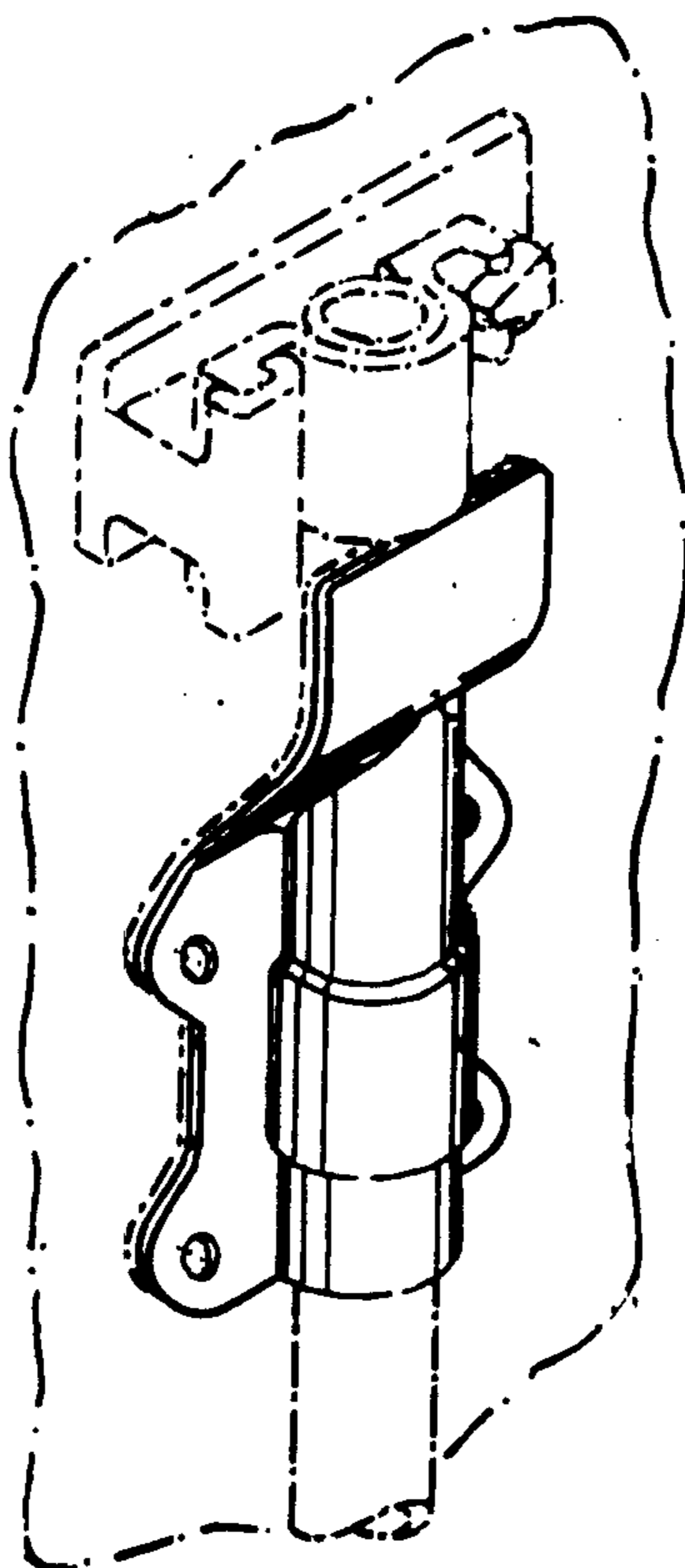

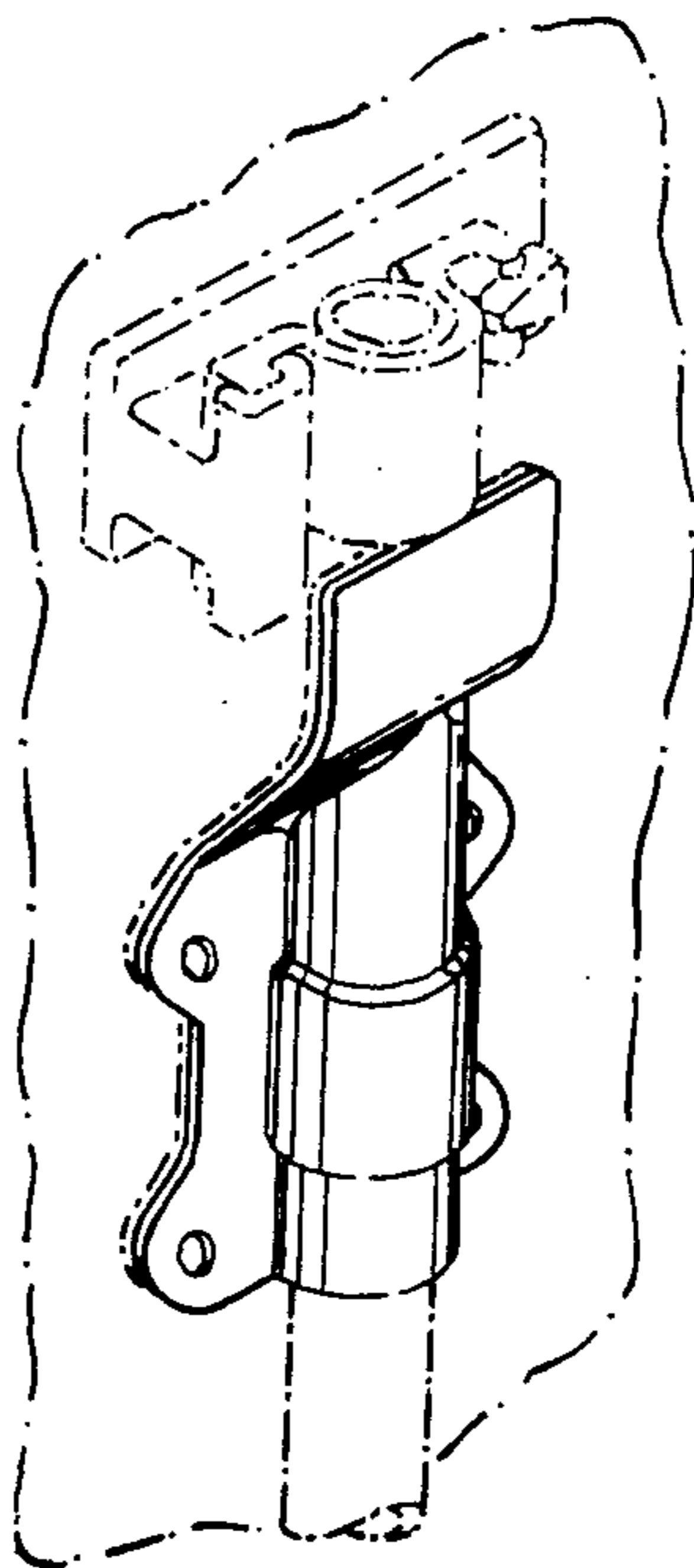

FIG. 1

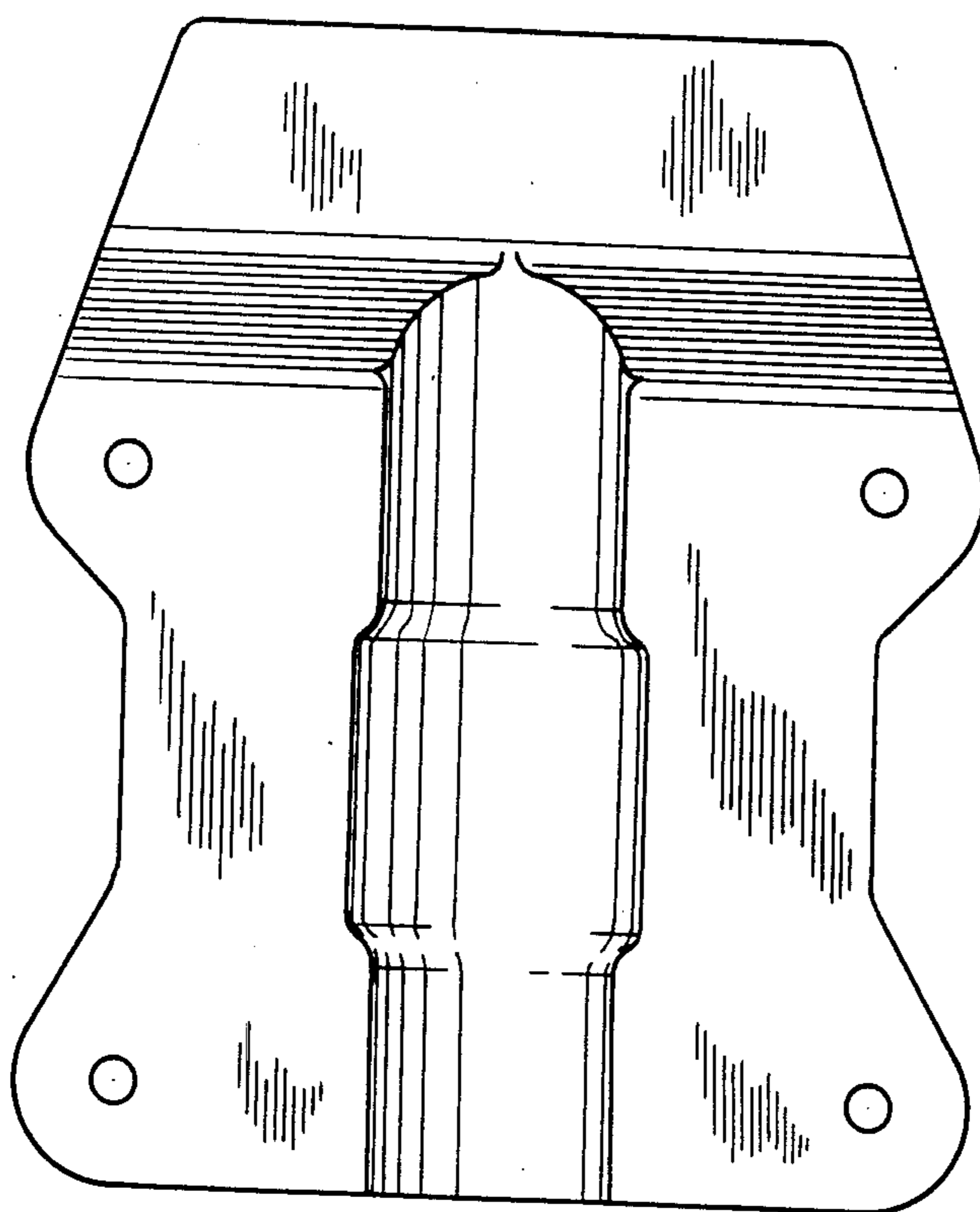

FIG. 6

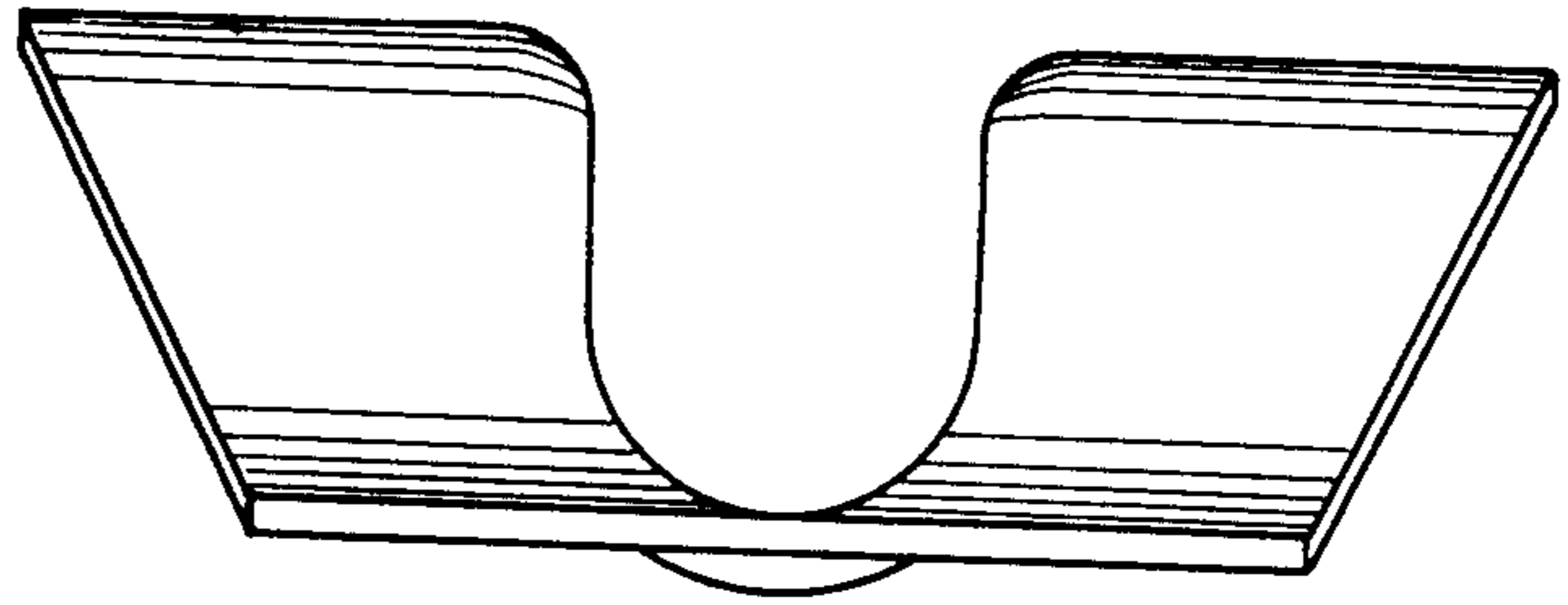

FIG. 4

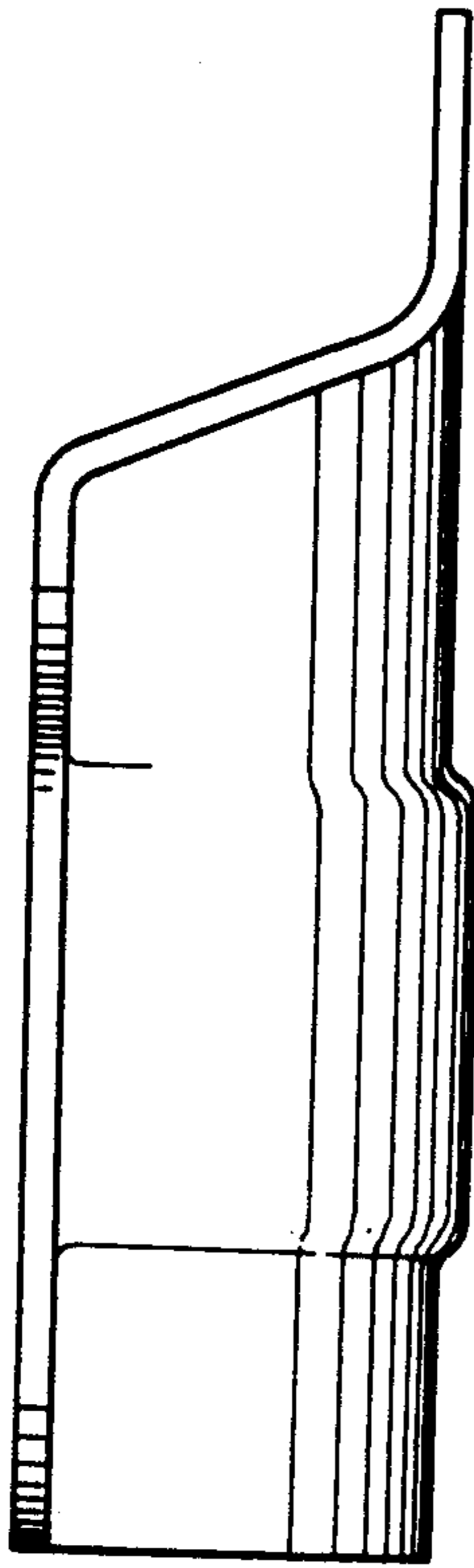

FIG. 3

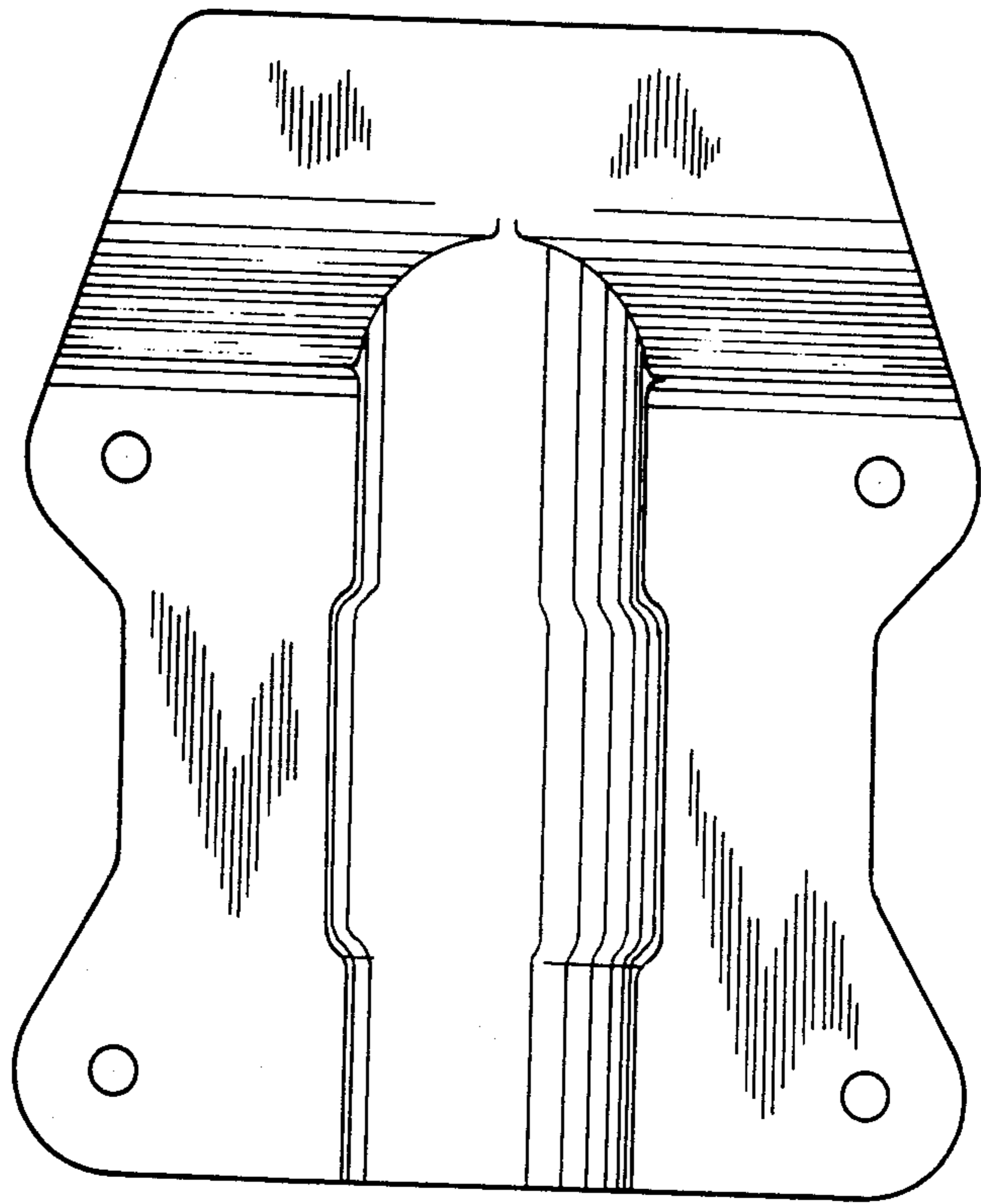

FIG. 2

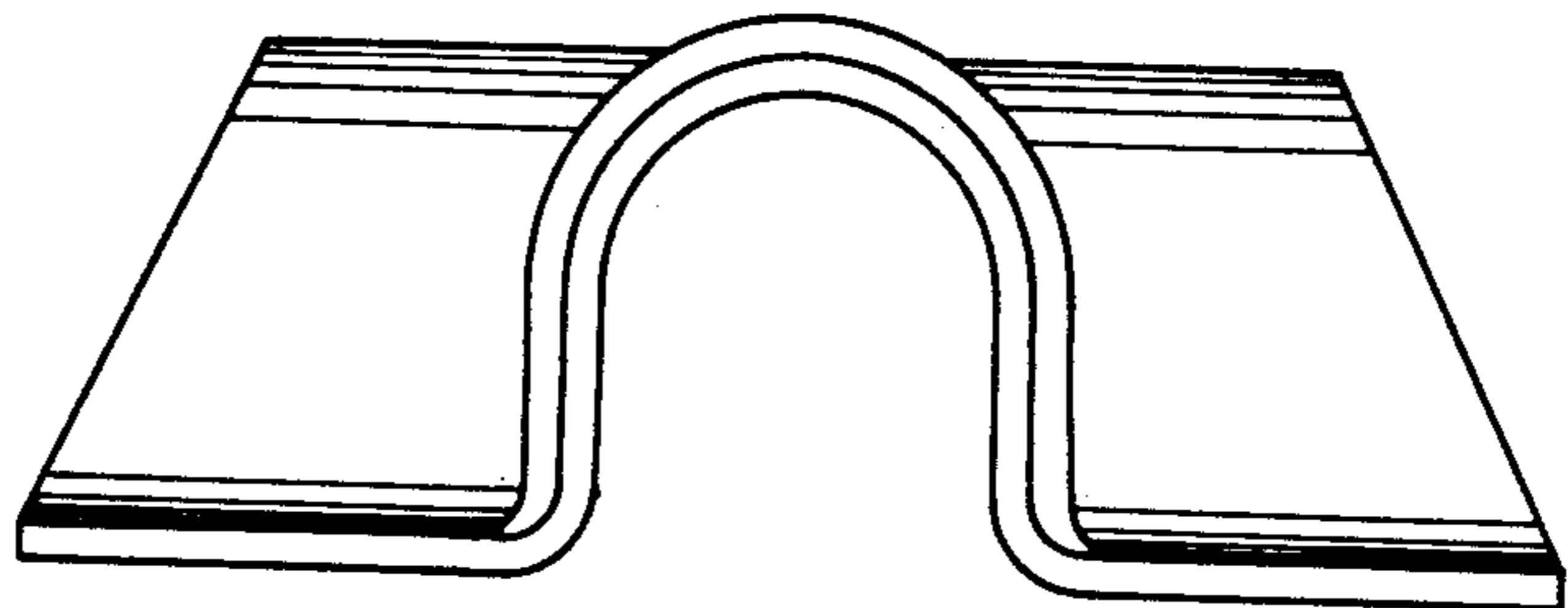

FIG. 5