

[54] PROTECTIVE COVER FOR ROLLS OF TOILET PAPER

[76] Inventor: Wai-Hung Woo, c/o Woody Trading Co. H.K., 38 Kam Lam St., 5th floor, Block "S", Mongkok, Kowloon, Hong Kong

[**] Term: 14 Years

[21] Appl. No.: 826,430

[22] Filed: Aug. 22, 1977

[30] Foreign Application Priority Data

Feb. 23, 1977 [GB] United Kingdom 978994/77

[51] Int. Cl. D23-02

[52] U.S. Cl. D6/86

[58] Field of Search D6/86, 89-92, D6/94, 96, 97, 99-102, 114, 130, 132, 136; 312/39, 41; 242/55.2, 55.3, 55.53

[56] References Cited

U.S. PATENT DOCUMENTS

D. 191,739	11/1961	Rosenblum	D6/86
D. 204,865	5/1966	Stewart	D6/86
D. 241,593	9/1976	Wriede	D6/86
2,606,724	8/1952	Hertz	312/39
3,467,456	9/1969	Chmela	D6/97

Primary Examiner—Wallace R. Burke
Assistant Examiner—B. J. Bullock
Attorney, Agent, or Firm—Stephen S. Townsend

[57] CLAIM

The ornamental design for a protective cover for rolls of toilet paper, as shown.

DESCRIPTION

FIG. 1 is a side elevational view of a protective cover for rolls of toilet paper showing my new design; FIG. 2 is a rear elevational view; FIG. 3 is a top plan view; FIG. 4 is a bottom plan view; FIG. 5 is a side elevational view, with the cover in the raised position; FIG. 6 is a perspective view; and FIG. 7 is a front elevational view.

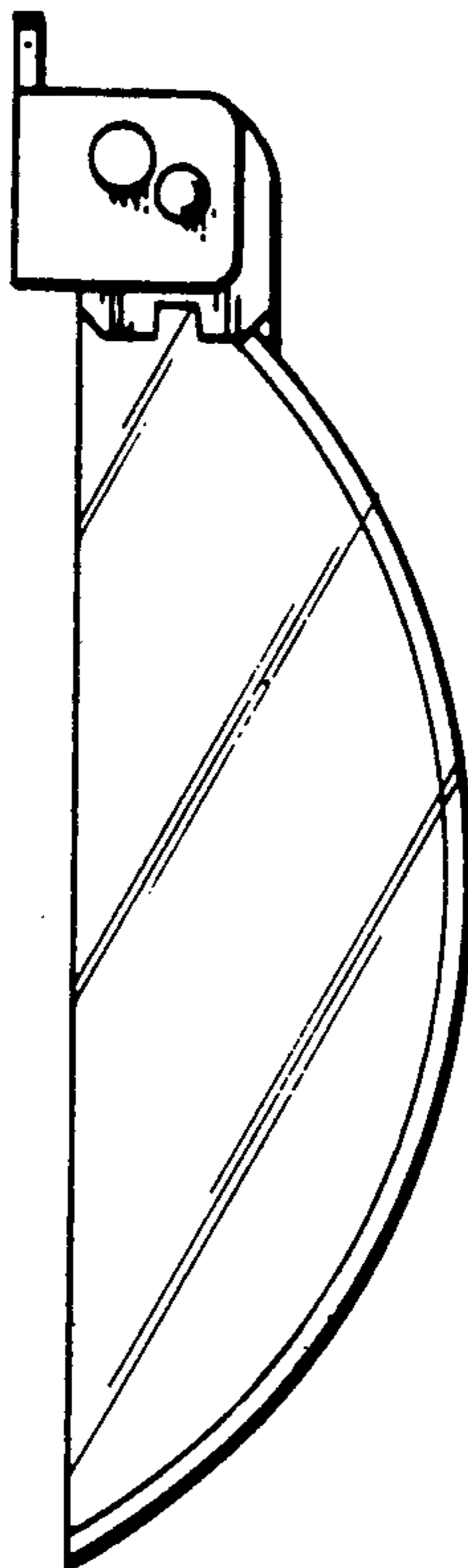

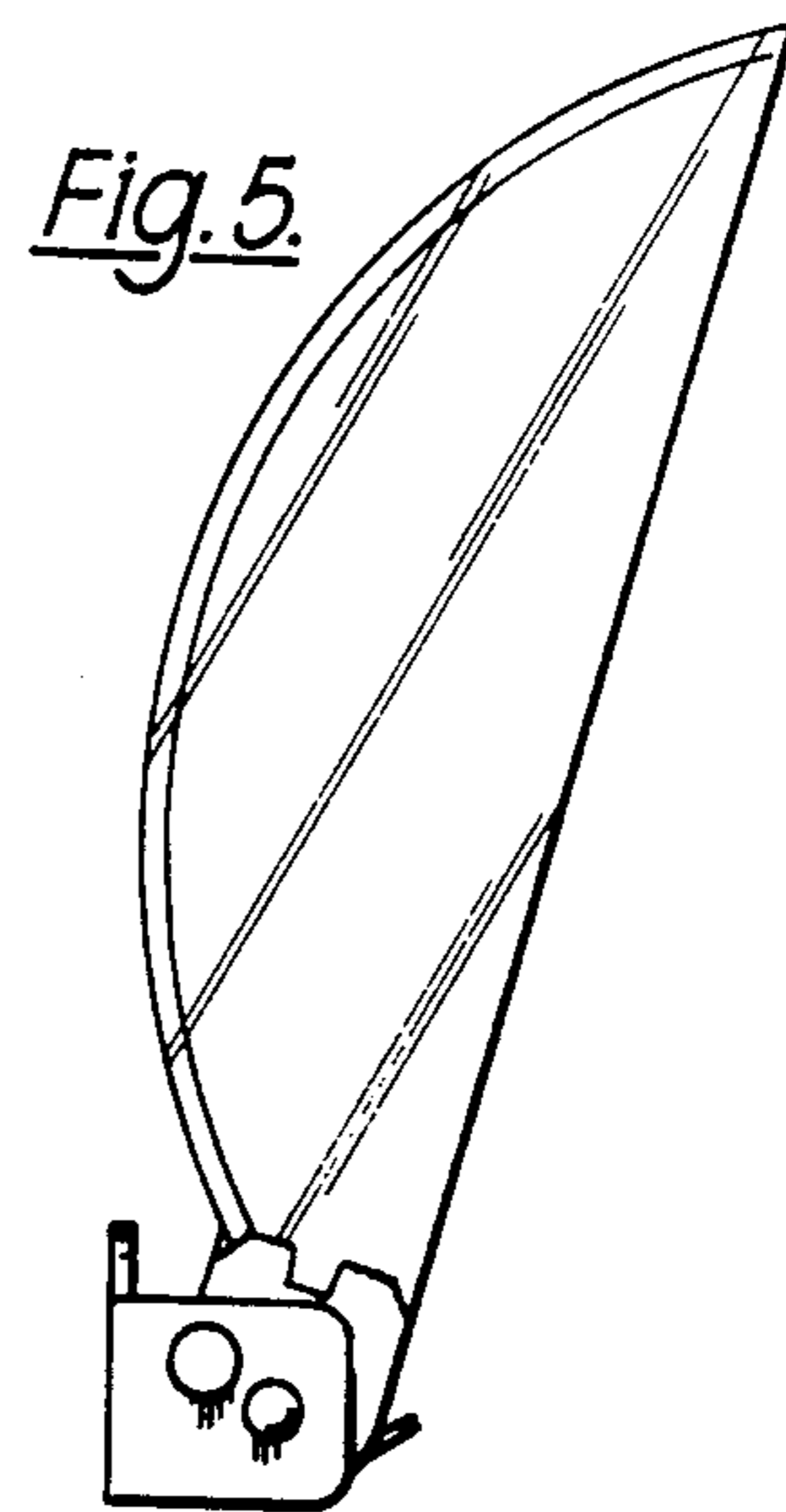
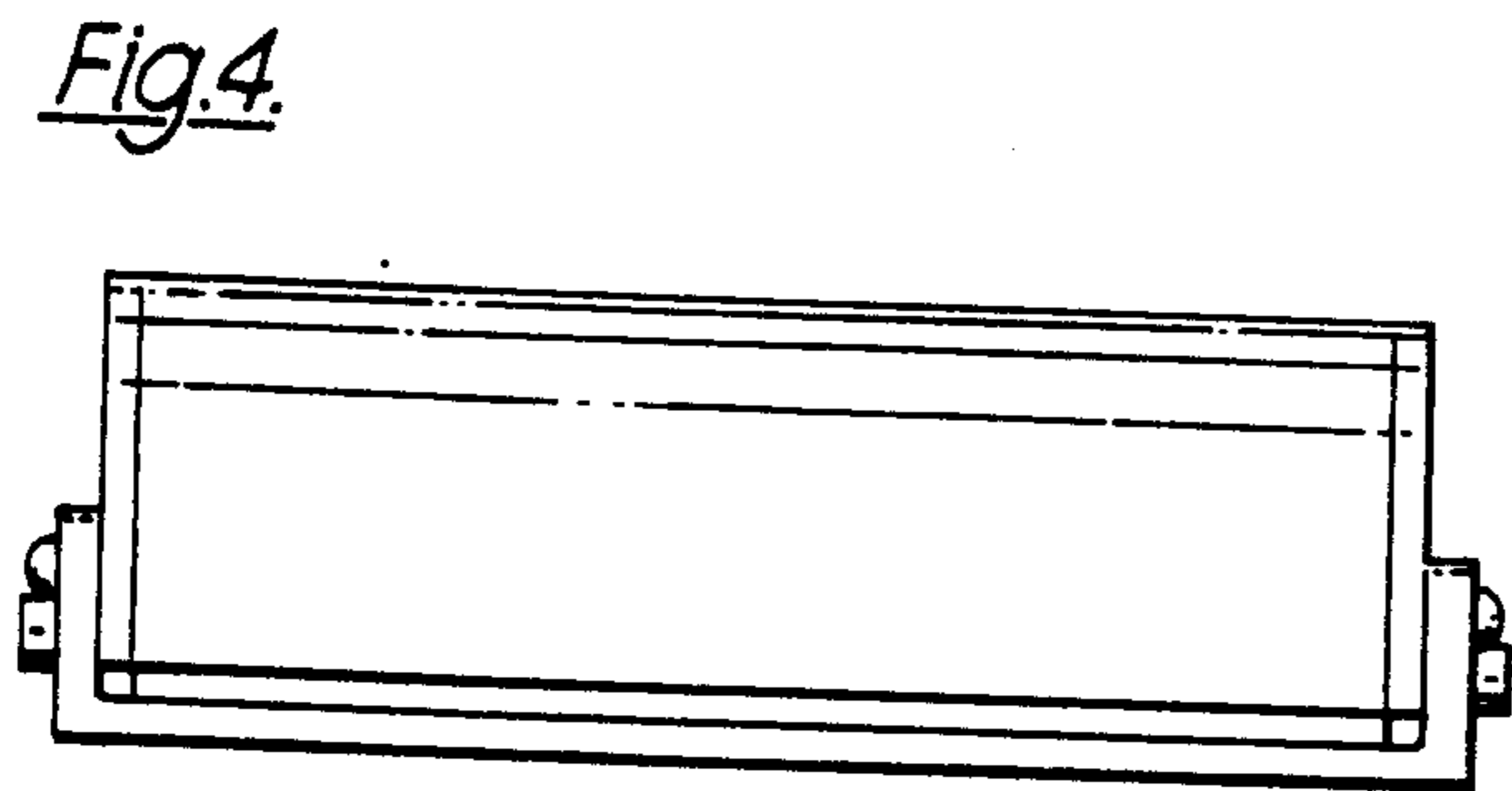
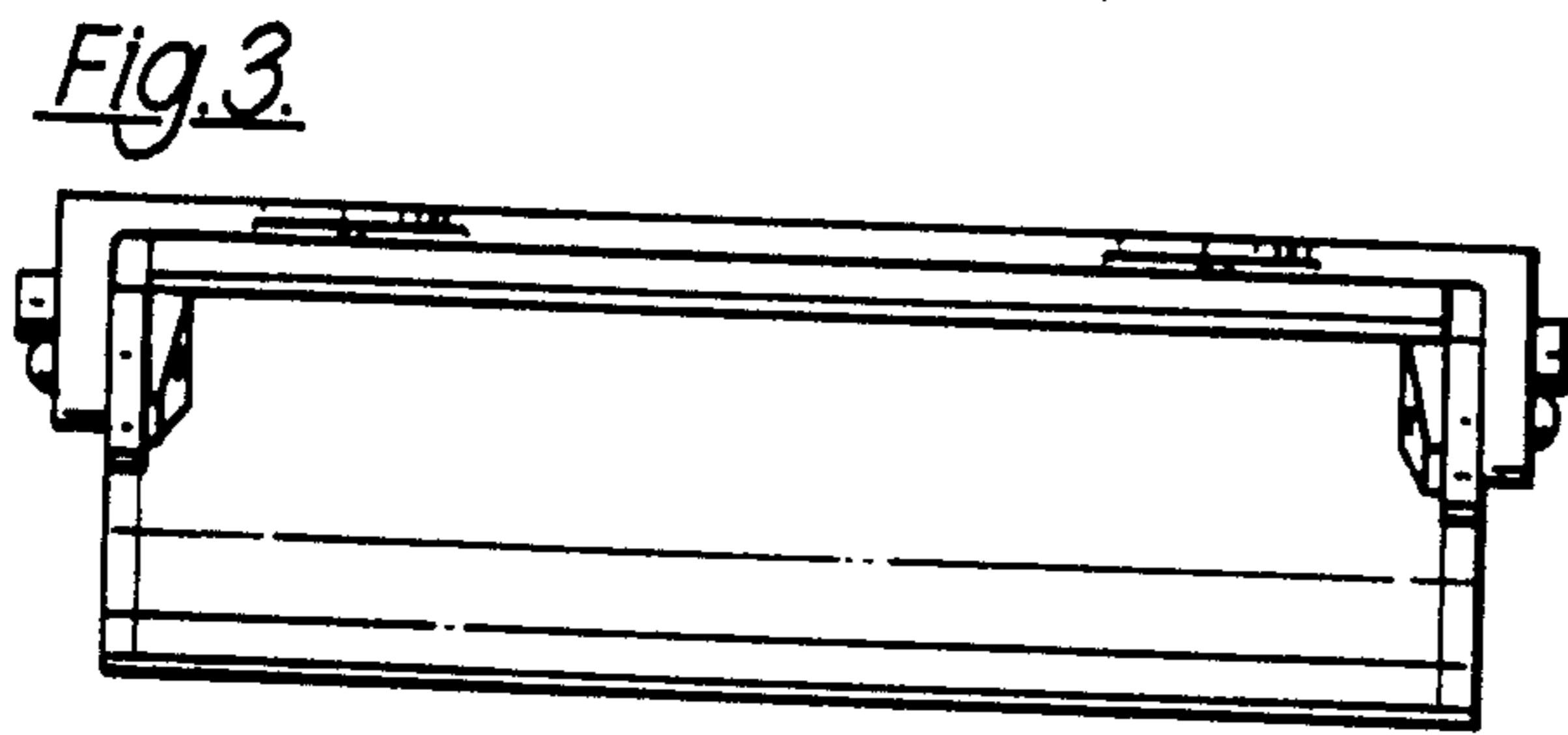
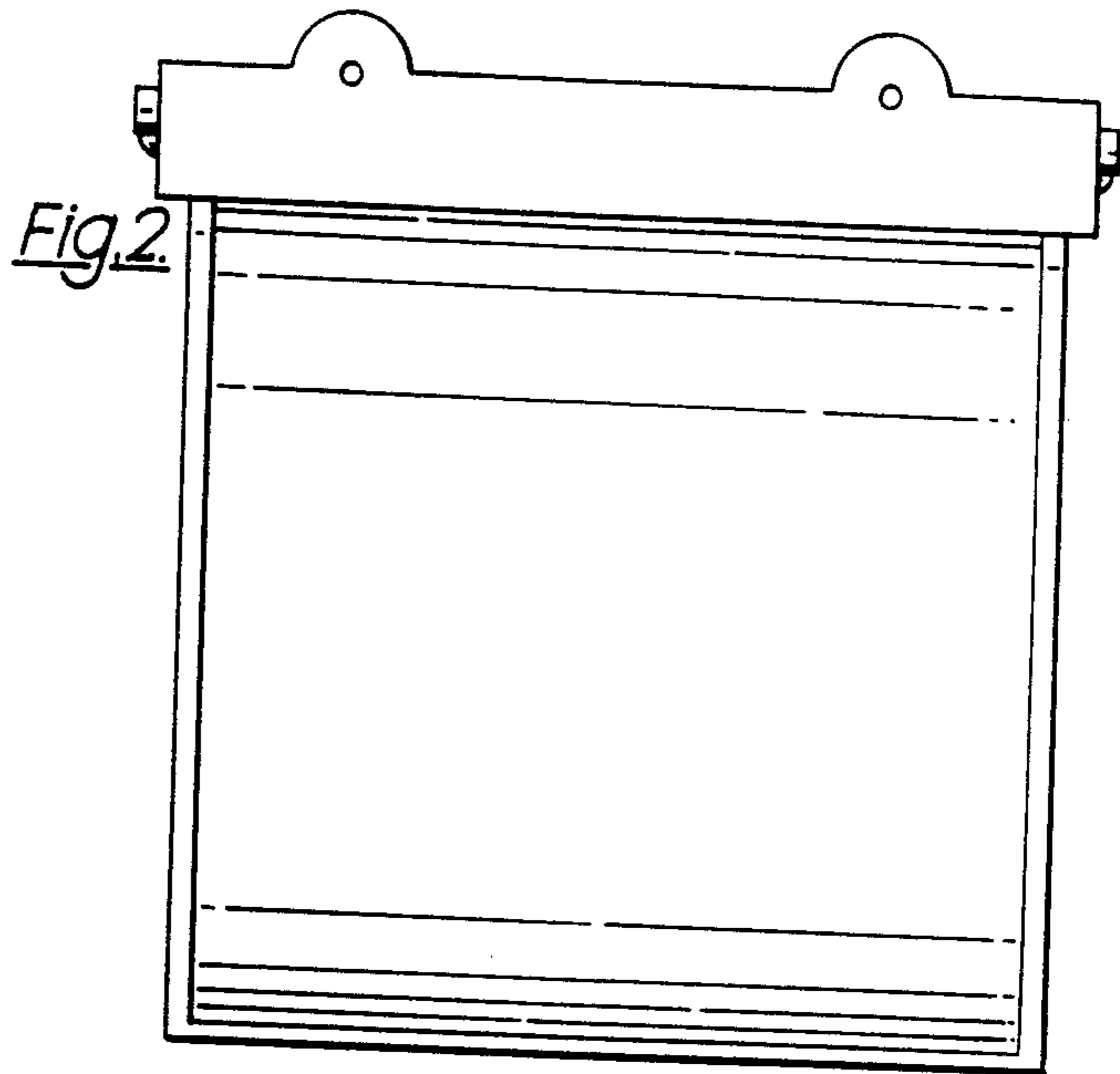
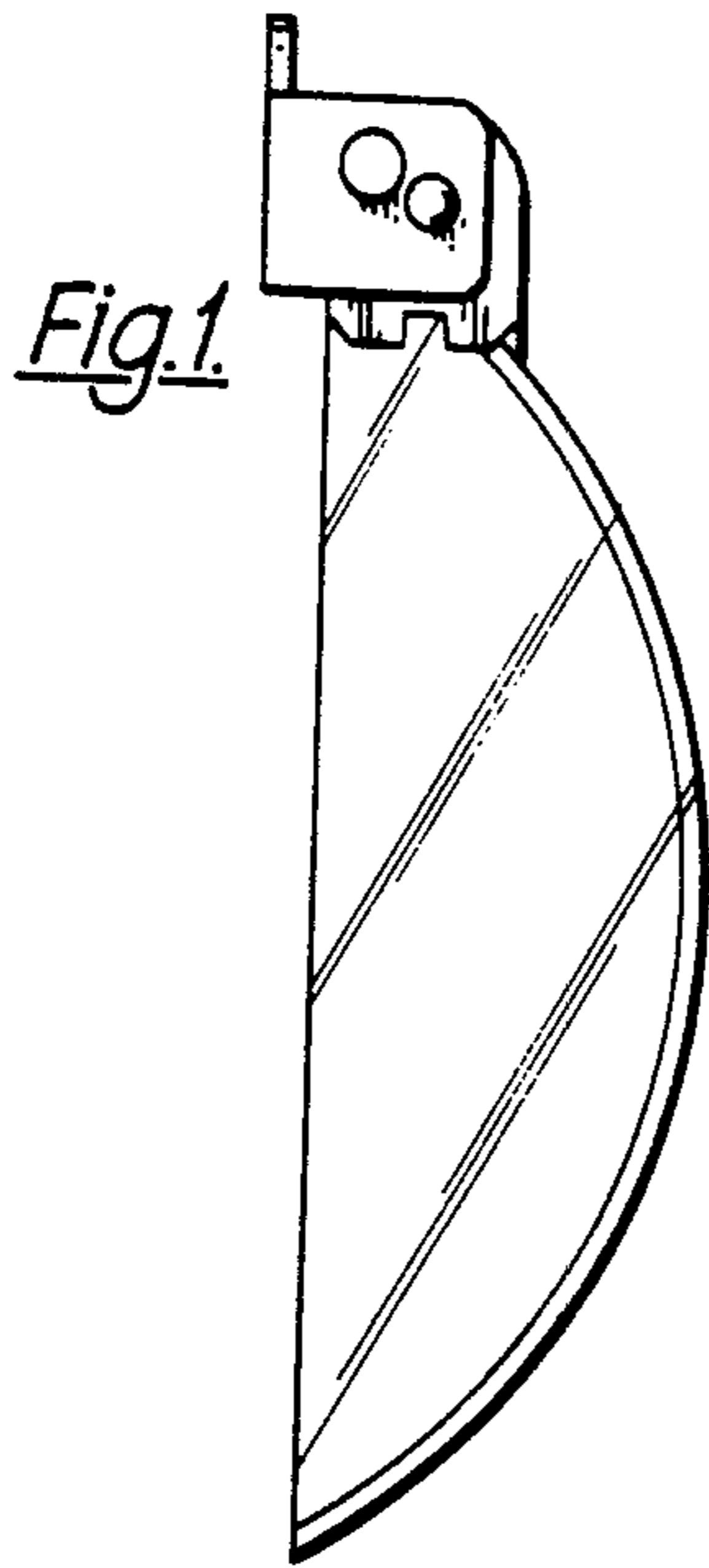

Fig. 6.

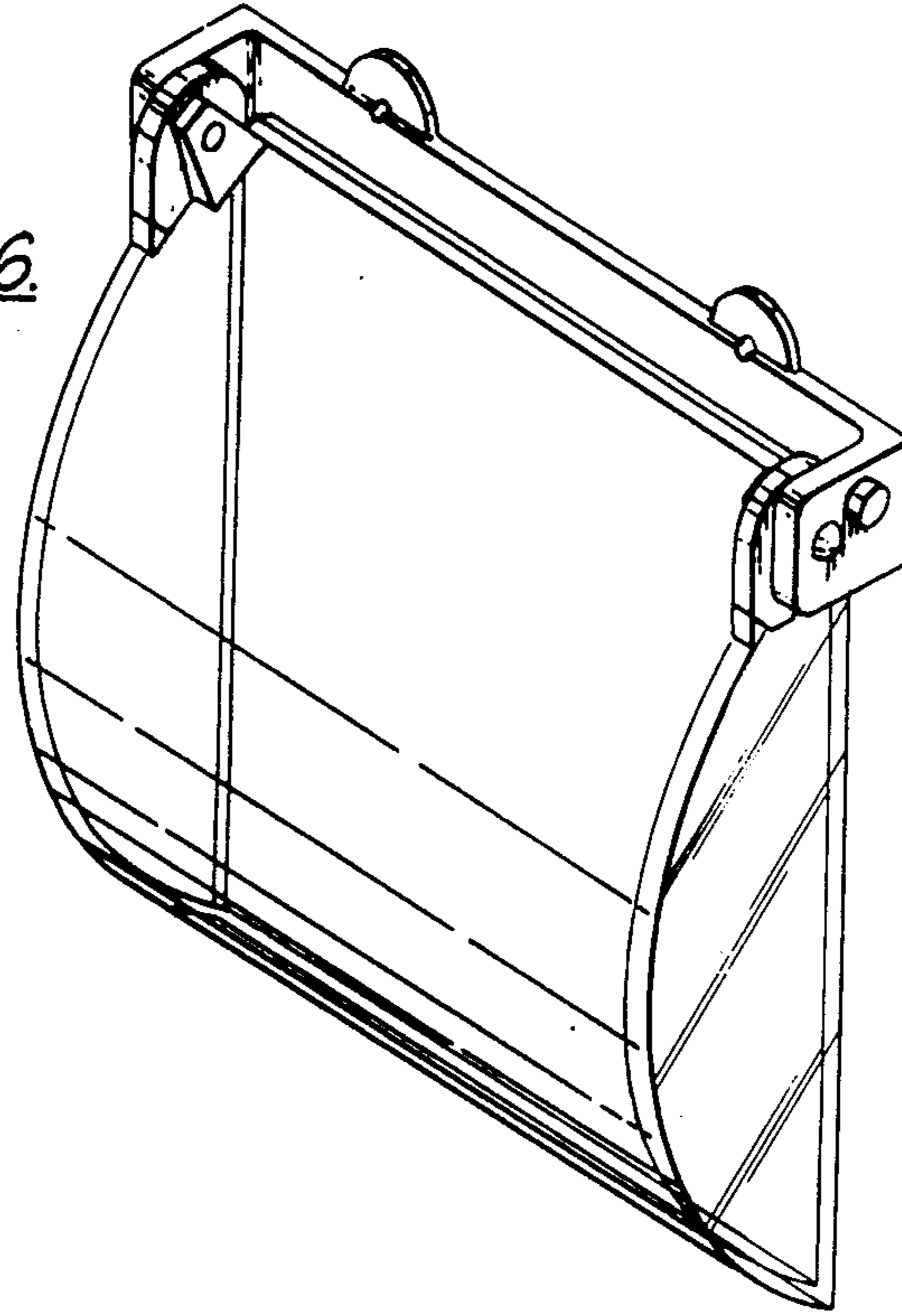

Fig. 7.

