

[54] NON-LETHAL PERSONAL DEFENSE WEAPON

[76] Inventor: **Burton M. Cantor**, 2519 E. Palmera Dr., Las Vegas, Nev. 89121

[**] Term: **14 Years**

[21] Appl. No.: **771,787**

[22] Filed: **Feb. 24, 1977**

[51] Int. Cl. **D22—02; D26—02**

[52] U.S. Cl. **D22/1; D48/24 A**

[58] Field of Search **42/1 G, 1 J, 1 Z; D22/1, 3, 6, 7, 99; D48/24 A; D34/15 PT, 15 VV**

[56] **References Cited**

U.S. PATENT DOCUMENTS

D. 215,934	11/1969	Litman	D22/3
D. 226,908	5/1973	Tadlock	D22/1
3,109,253	11/1963	Eig	D22/1 UX

Primary Examiner—A. Hugo Word
Attorney, Agent, or Firm—Jerome P. Bloom

[57] **CLAIM**

The ornamental design for a non-lethal personal defense weapon, substantially as shown and described.

DESCRIPTION

FIG. 1 is a perspective view of a non-lethal personal defense weapon in accordance with my design, taken from the top and one side thereof;
FIG. 2 is a perspective view of said weapon taken from the rear, top and opposite side thereof;
FIG. 3 is a side elevation view of said one side of said weapon;
FIG. 4 is a side elevation view of said opposite side of said weapon;
FIG. 5 is a view of said weapon taken from the top thereof;
FIG. 6 is a view of said weapon taken from the bottom thereof;
FIG. 7 is a front elevation view of said weapon; and
FIG. 8 is a rear elevation view of said weapon.

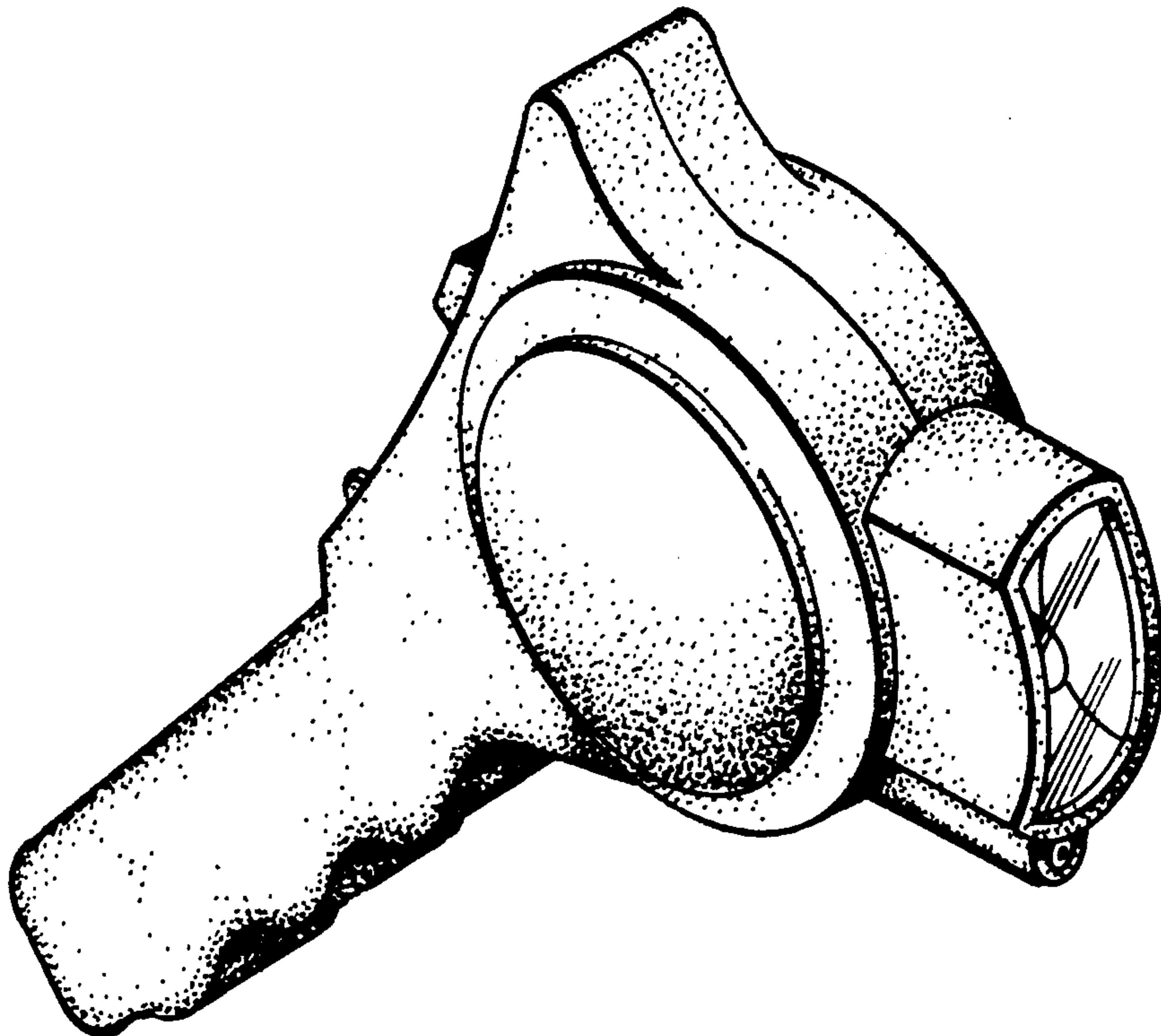

FIG-1

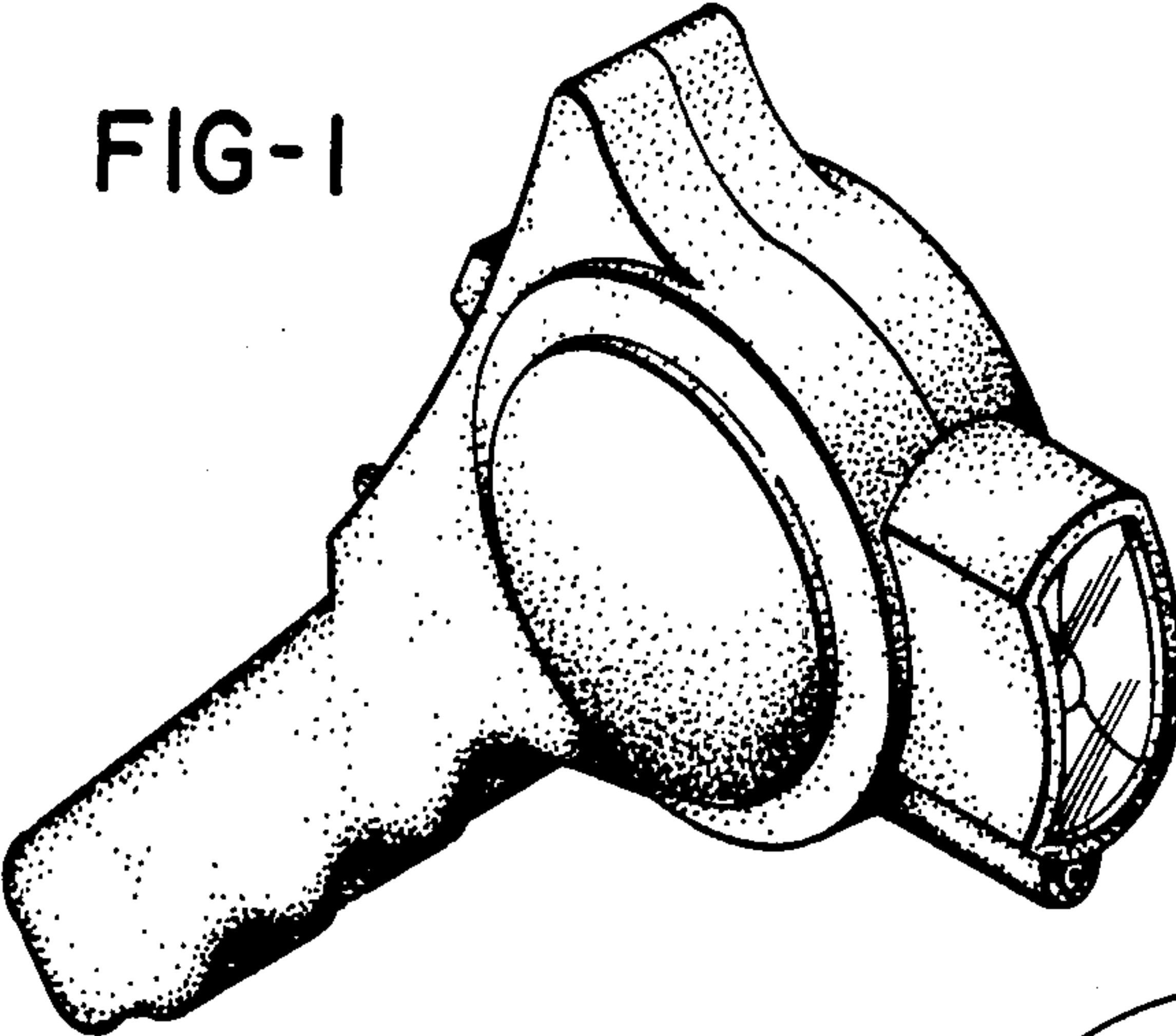

FIG-2

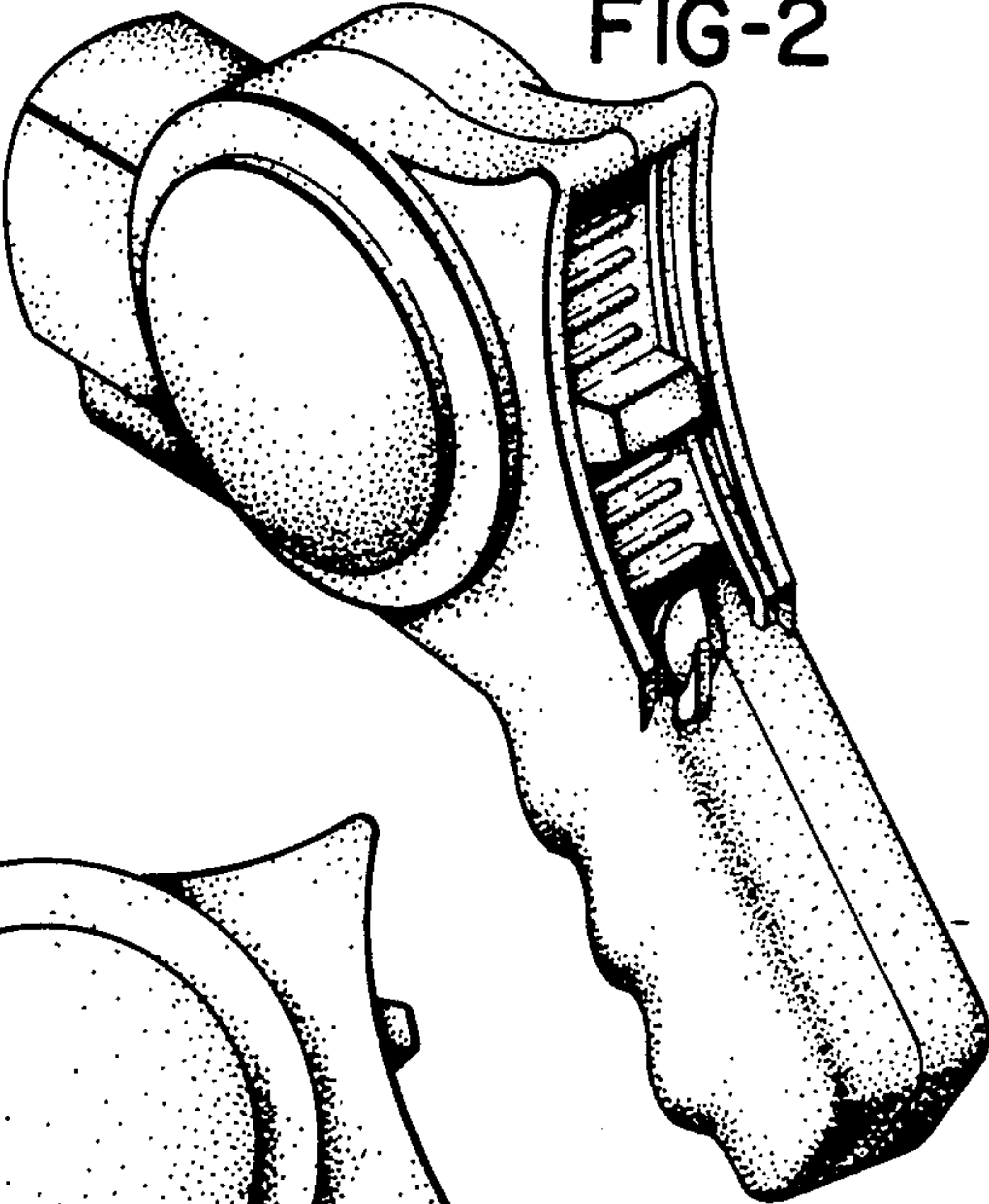

FIG-3

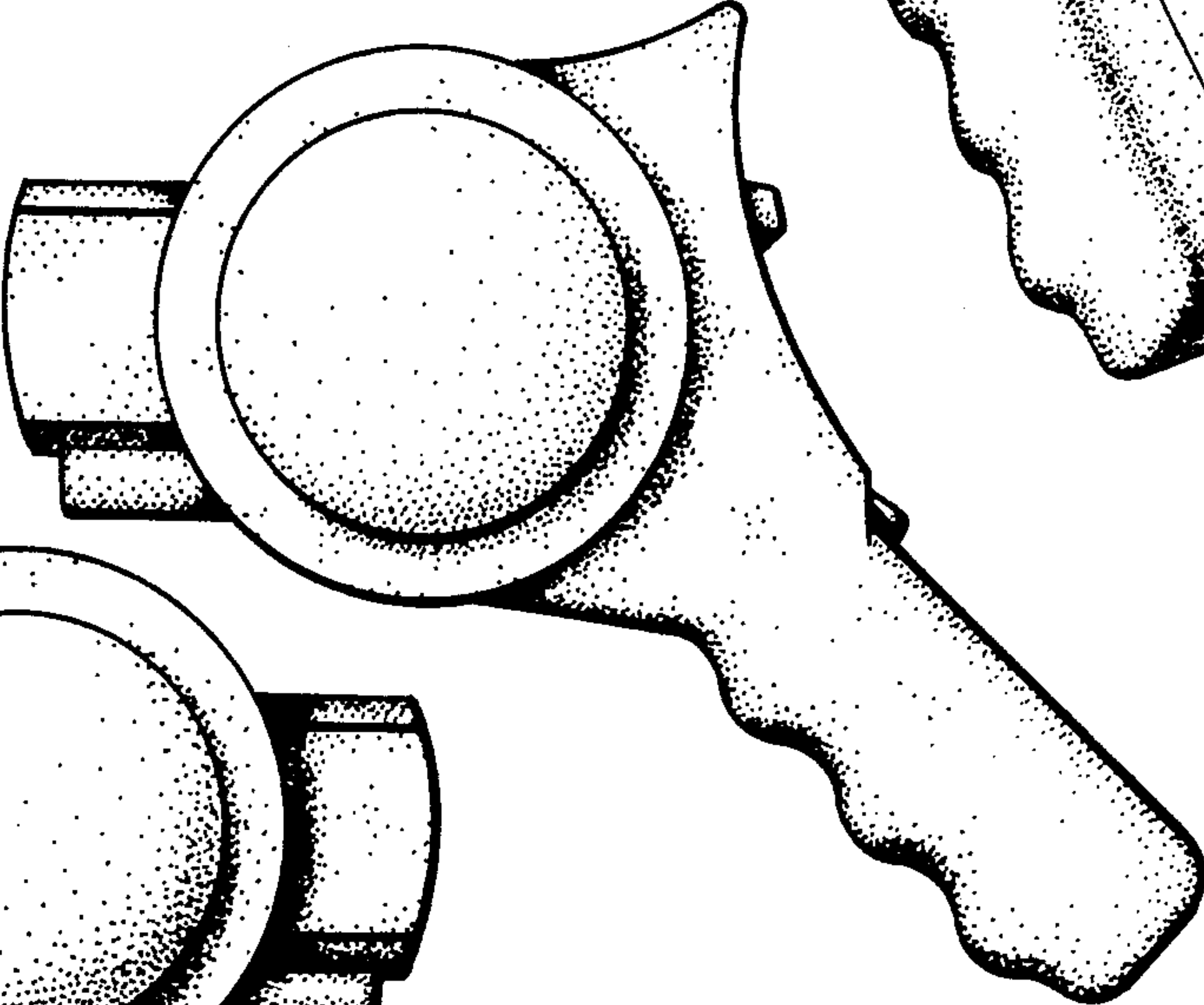

FIG-4

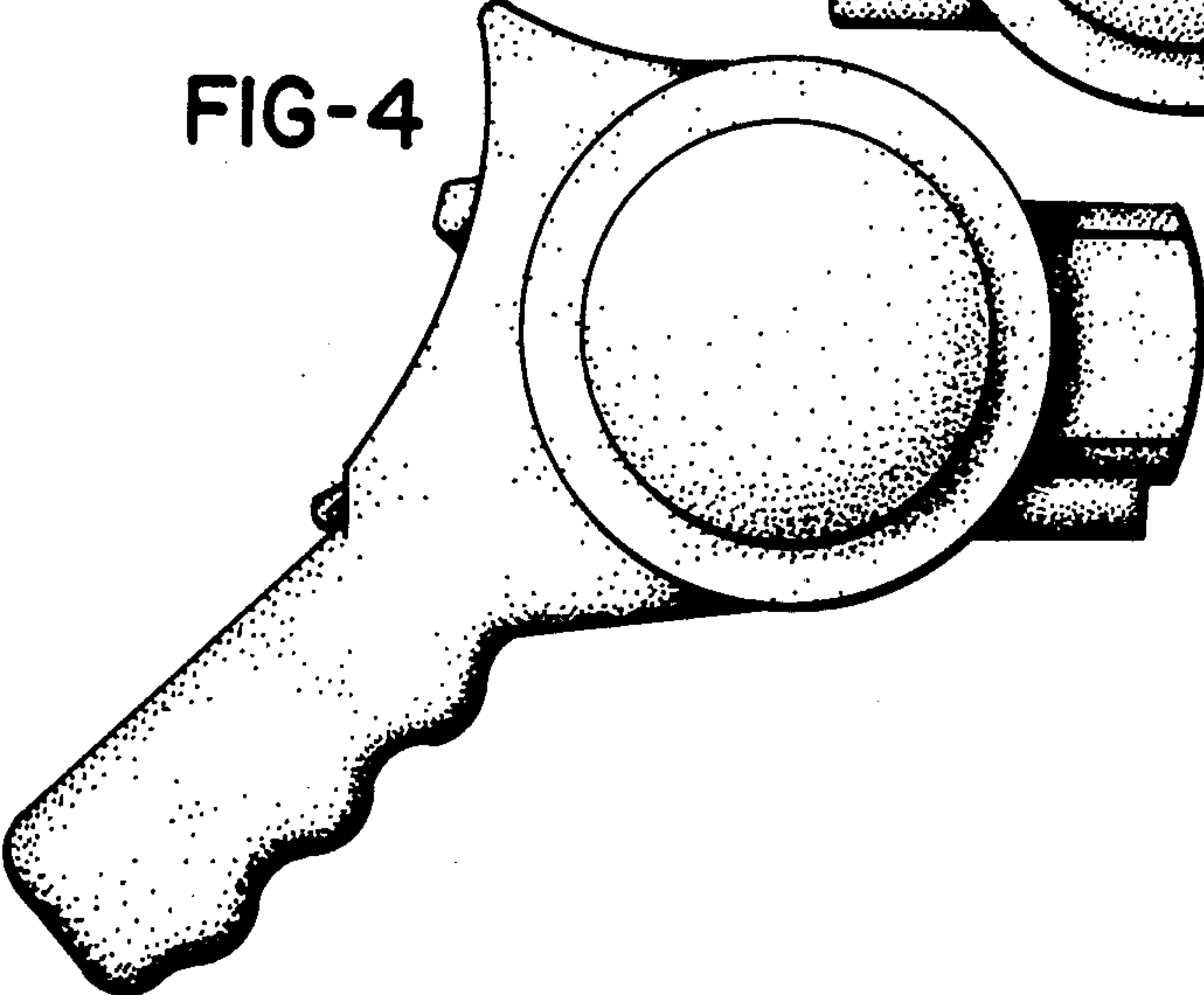

FIG-5

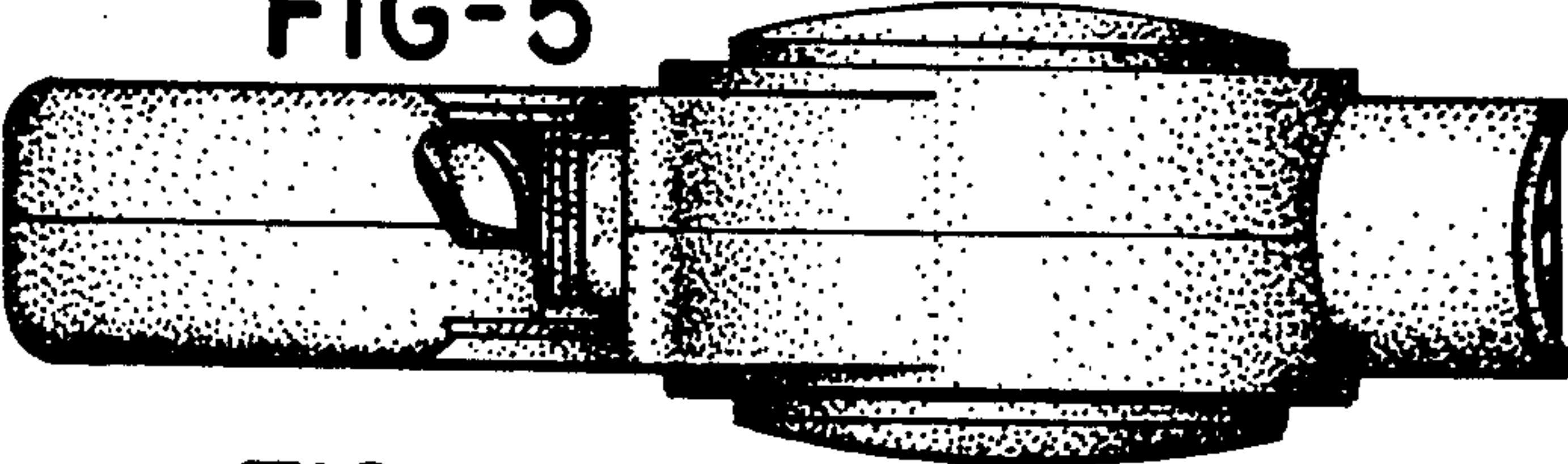

FIG-6

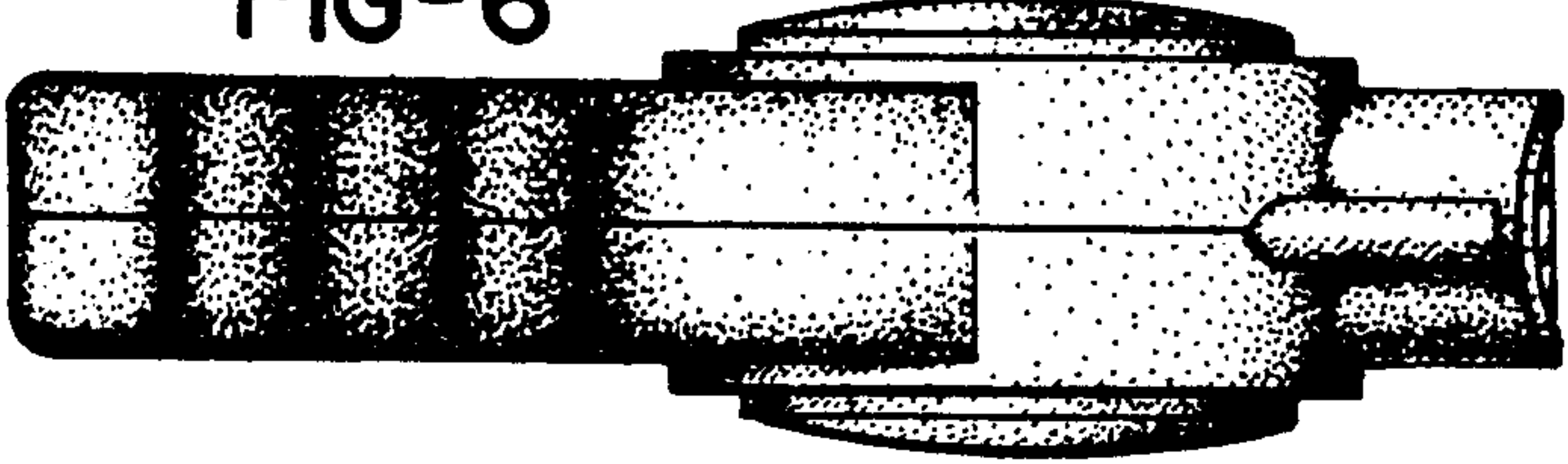

FIG-7

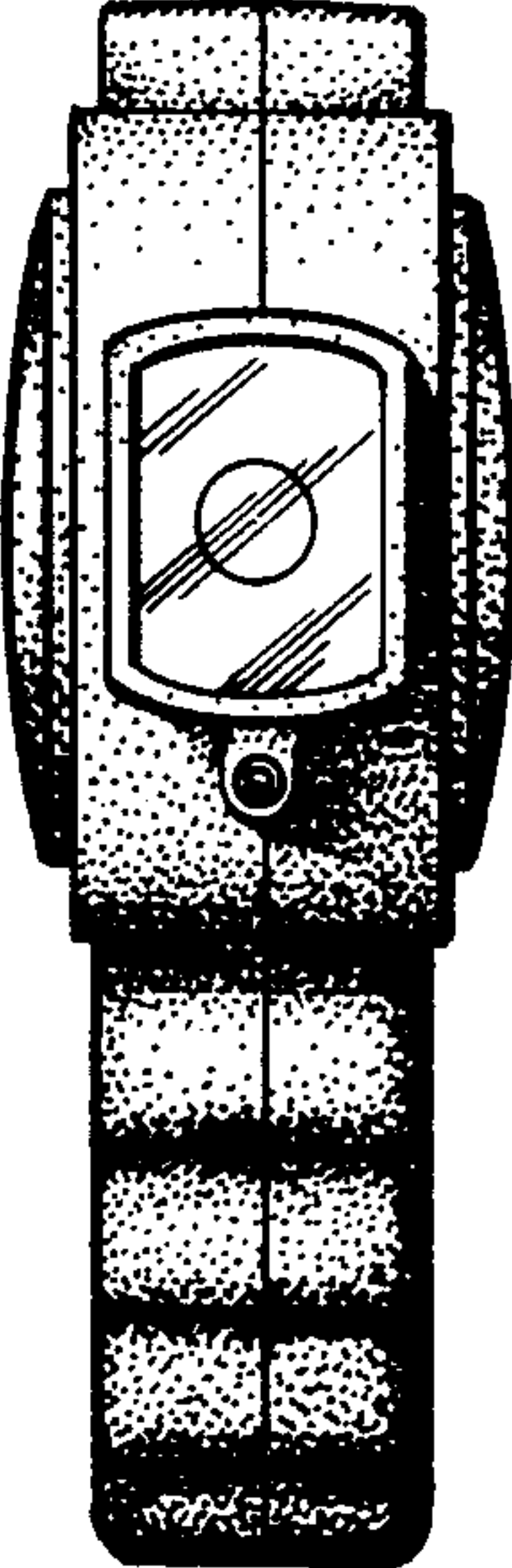

FIG-8

