

[54] HANDLE FOR HAND SAW

[75] Inventor: Laird F. Covey, Easton, Conn.

[73] Assignee: The Stanley Works, New Britain, Conn.

[**] Term: 14 Years

[21] Appl. No.: 712,461

[22] Filed: Aug. 9, 1976

[51] Int. Cl. D8-03

[52] U.S. Cl. D8/97

[58] Field of Search D8/97, 95; 7/13 R

[56] References Cited

U.S. PATENT DOCUMENTS

D. 139,218	10/1944	Wickbergh	D8/97
D. 152,760	2/1949	Weaver	D8/97
D. 231,076	4/1974	Carlsson	D8/97

OTHER PUBLICATIONS

EIA Bushman Kombi Saw Flier, Handsaw Handle on page.

Primary Examiner—Alan P. Douglas
Attorney, Agent, or Firm—Peter L. Costas

[57] CLAIM

The ornamental design for a handle for hand saw, as shown and described.

DESCRIPTION

FIG. 1 is a side elevational view of a saw handle employing my design and the stippling indicating a roughened surface texture for the grip portion;
 FIG. 2 is an enlarged side elevational view of the handle;
 FIG. 3 is a top plan view thereof;
 FIG. 4 is a bottom view thereof;
 FIG. 5 is a front elevational view thereof;
 FIG. 6 is a rear elevational view thereof;
 FIG. 7 is a section view along the line 7—7 of FIG. 2; and
 FIG. 8 is a sectional view along the line 8—8 of FIG. 2.

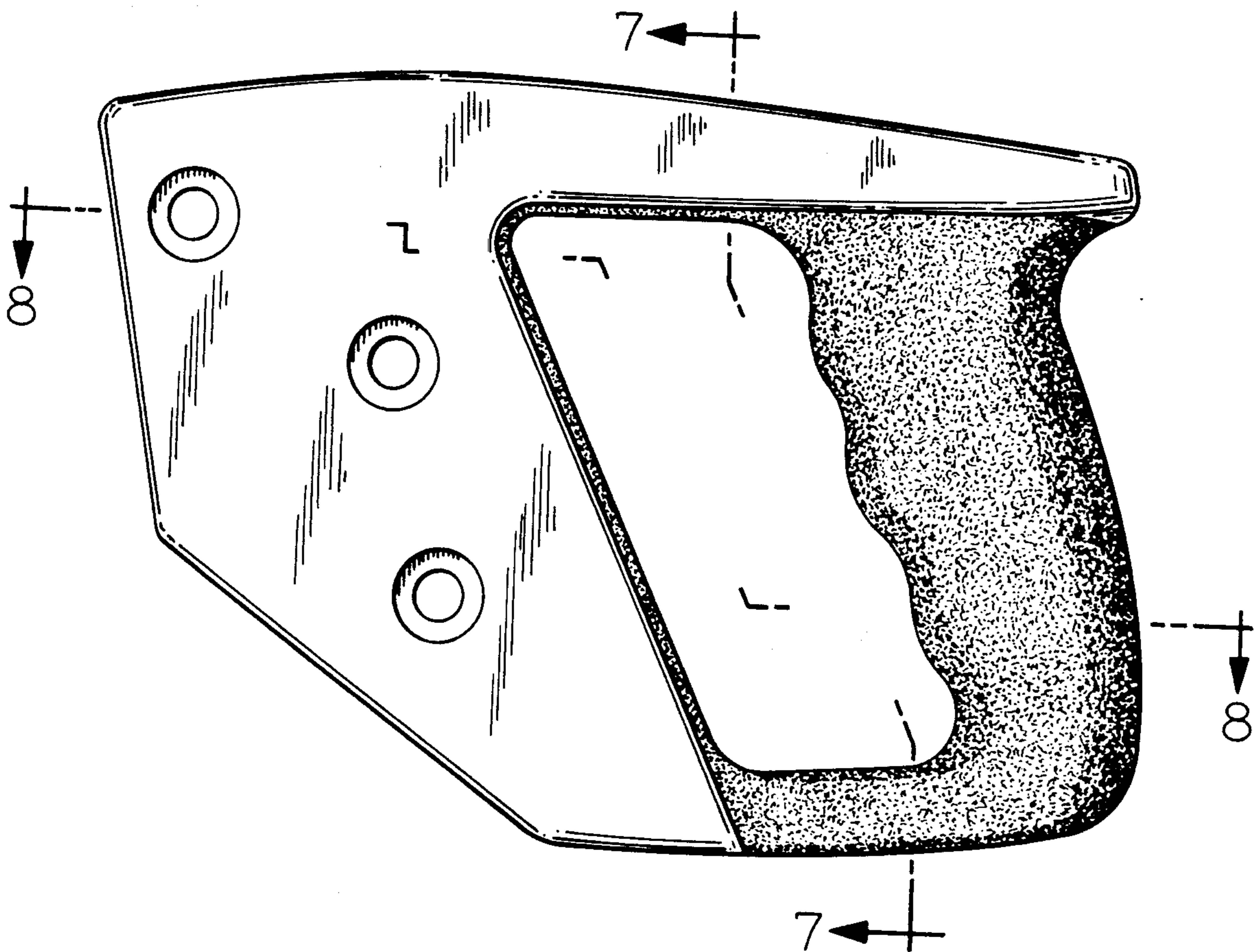

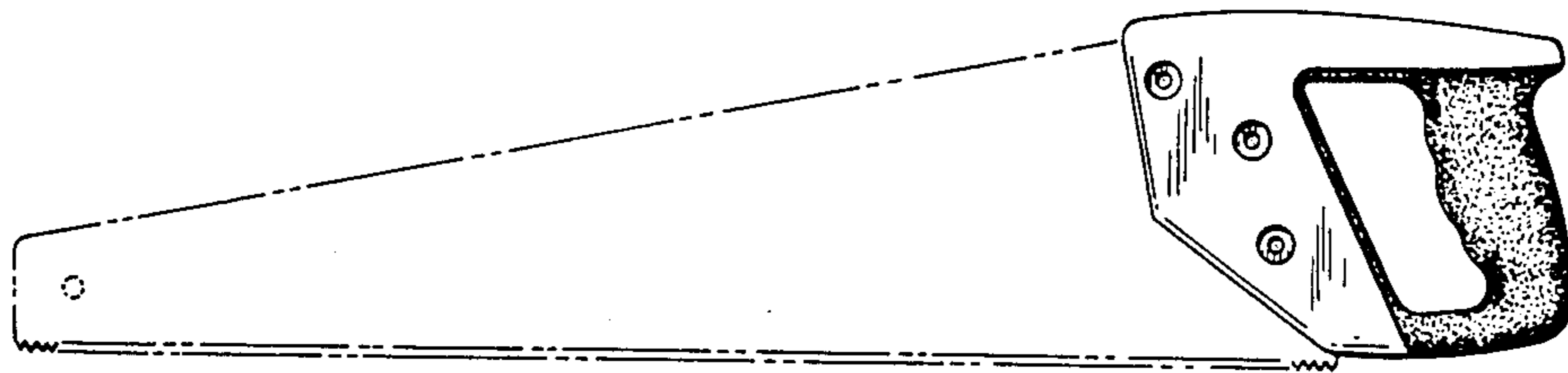

FIG. 1

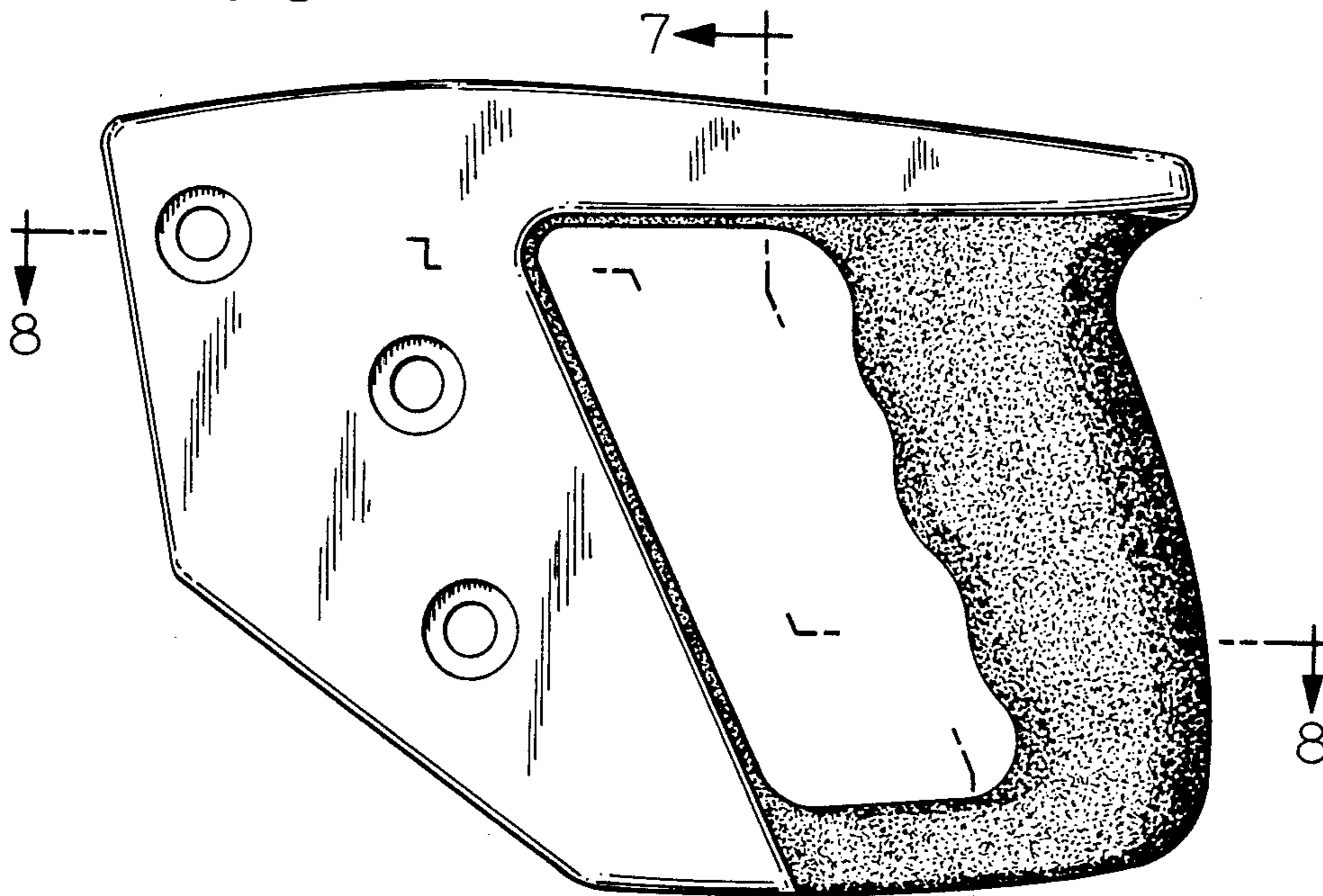

FIG. 2

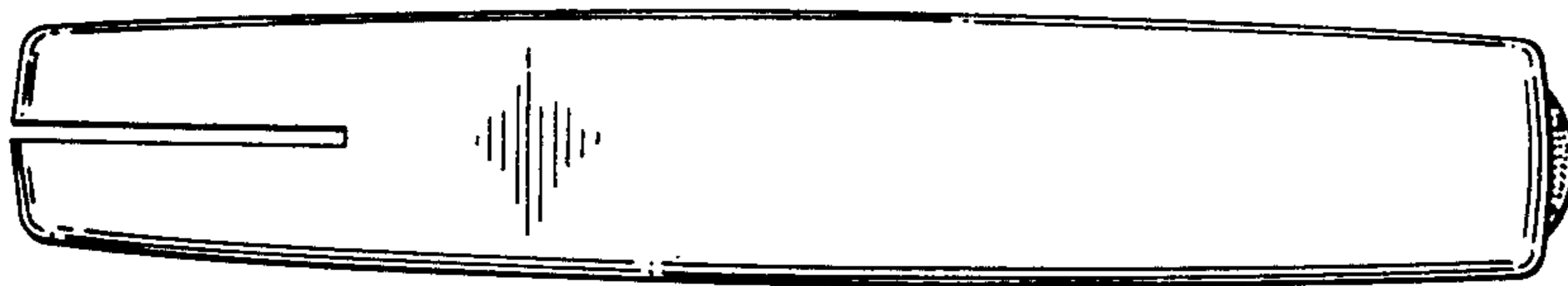

FIG. 3

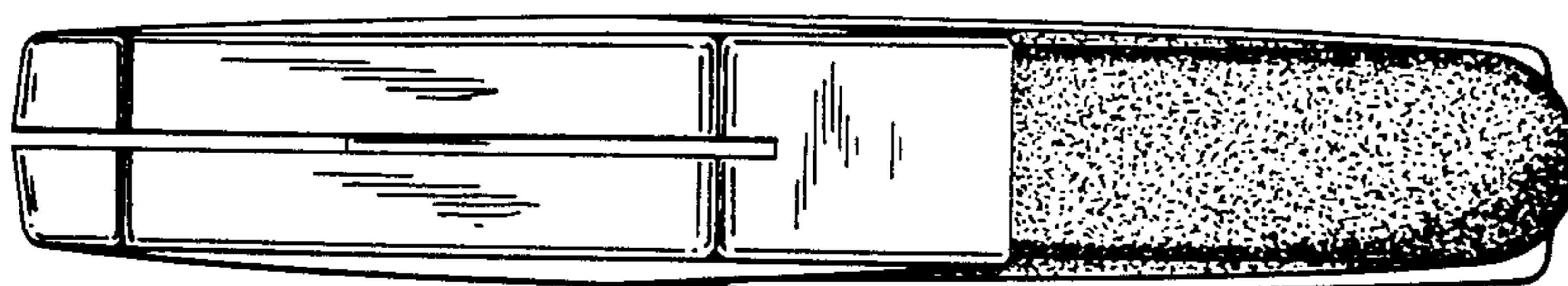

FIG. 4

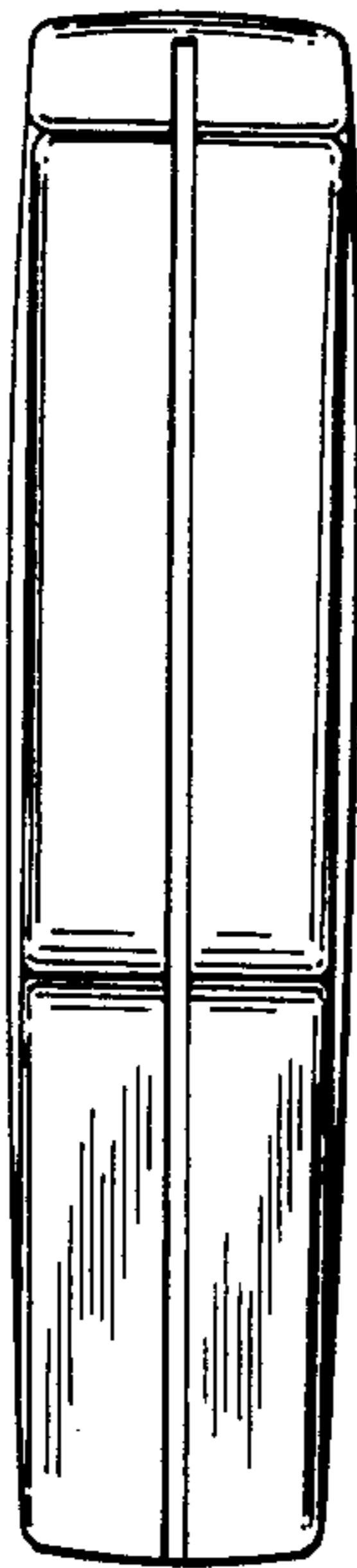

FIG. 5

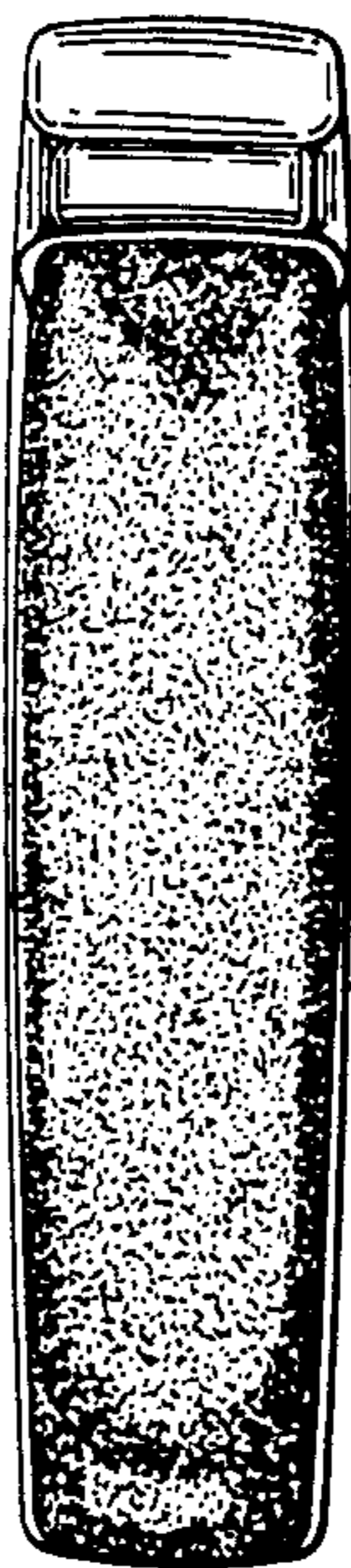

FIG. 6



FIG. 7



FIG. 8