

[54] JAR OPENER

[76] Inventor: Howard A. Hutson, P.O. Box 1415, Denver, Colo. 80201

[**] Term: 14 Years

[21] Appl. No.: 722,633

[22] Filed: Sep. 13, 1976

[51] Int. Cl. D7-06

[52] U.S. Cl. D8/37; D8/40

[58] Field of Search 81/3.1 R, 3.3 R, 3.32, 81/3.4; D8/37, 34, 40, 18, 43

[56] References Cited

U.S. PATENT DOCUMENTS

D. 194,118	11/1962	Woodbury	D8/40
2,053,246	9/1936	Lurcott	81/3.1 R
3,120,771	2/1964	Woodbury	81/3.4

Primary Examiner—Winifred E. Herrmann
Attorney, Agent, or Firm—Philip H. Sheridan

[57] CLAIM

The ornamental design for a jar opener, as shown.

DESCRIPTION

FIG. 1 is a bottom plan view of a jar opener showing my new design;

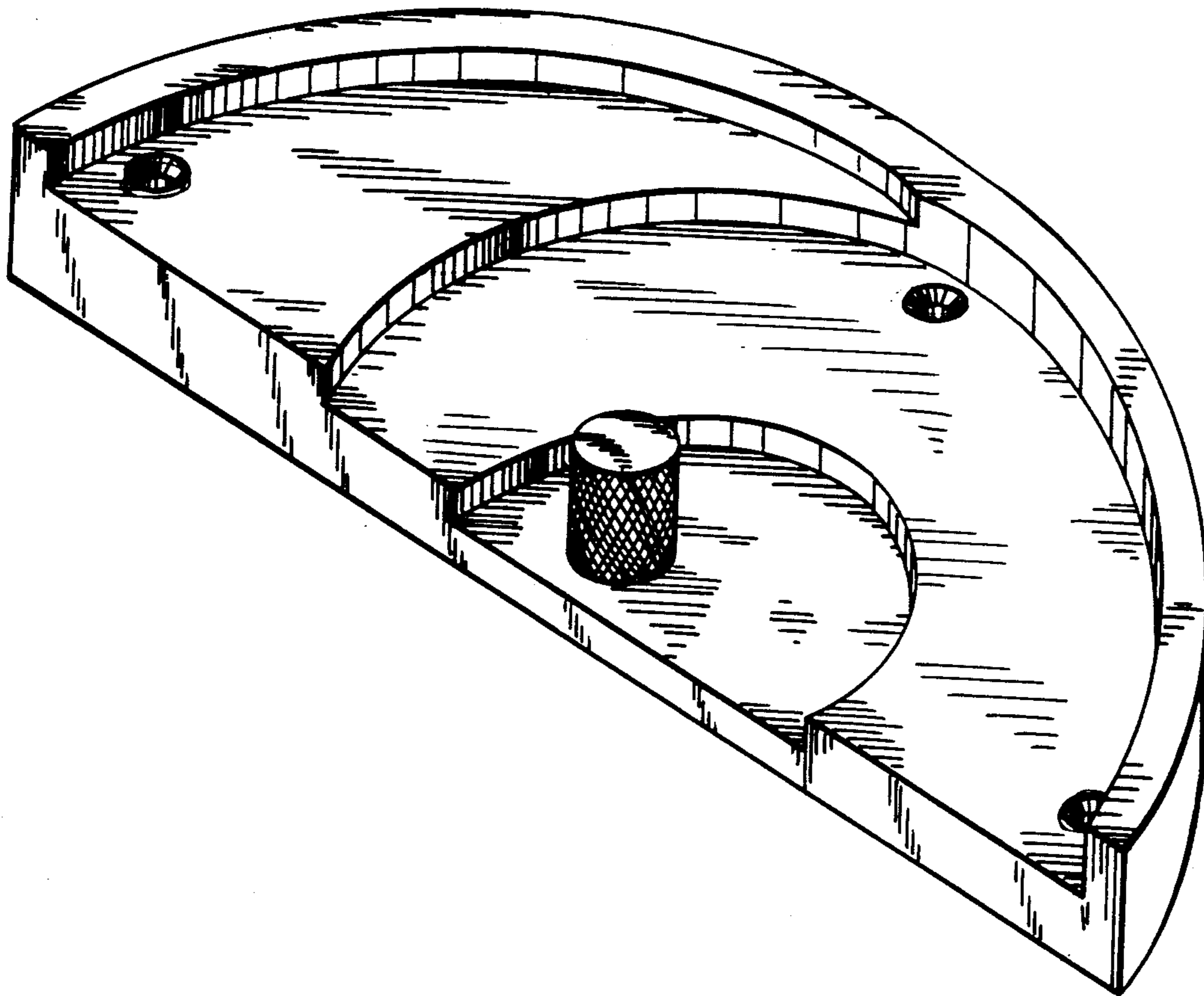
FIG. 2 is a front side elevational view thereof;

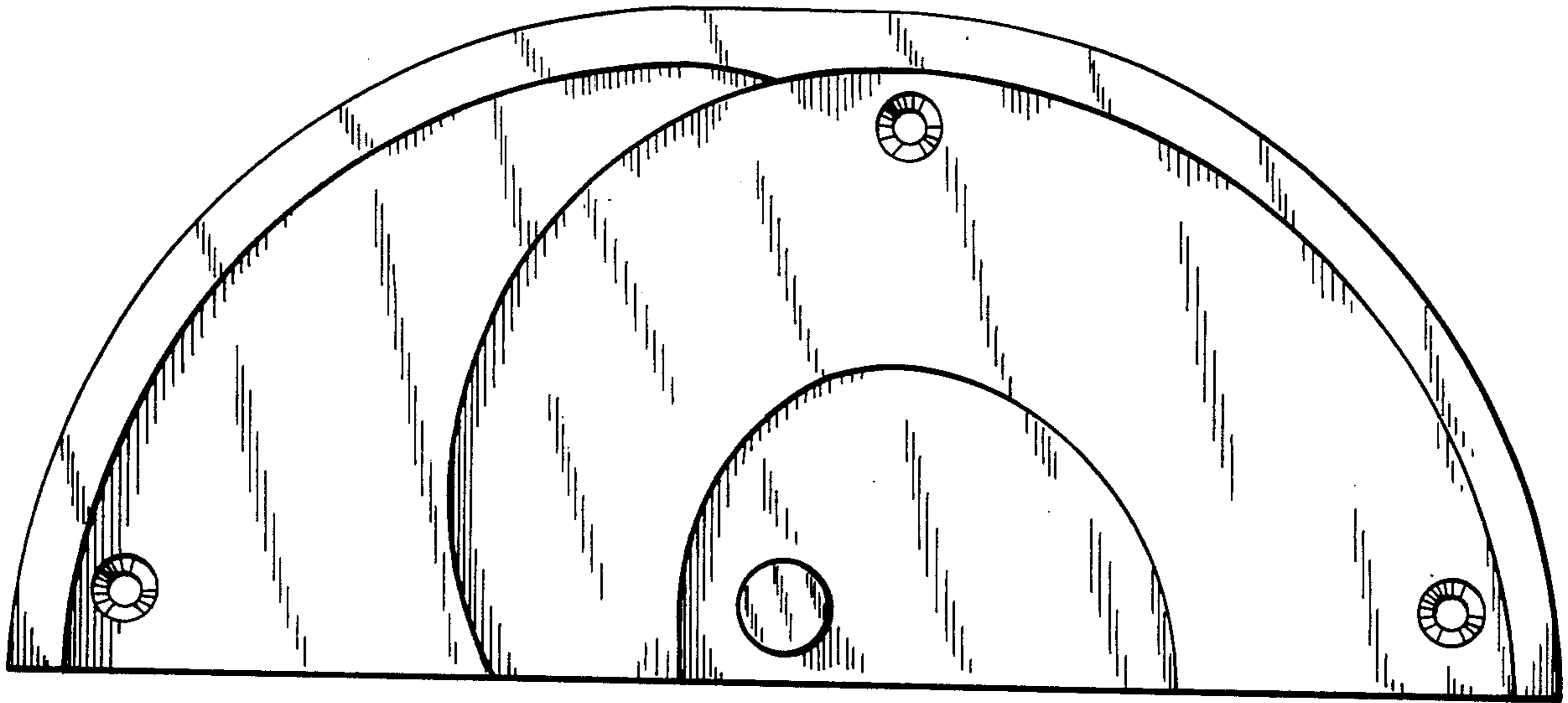
FIG. 3 is an end elevational view thereof;

FIG. 4 is a top plan view thereof;

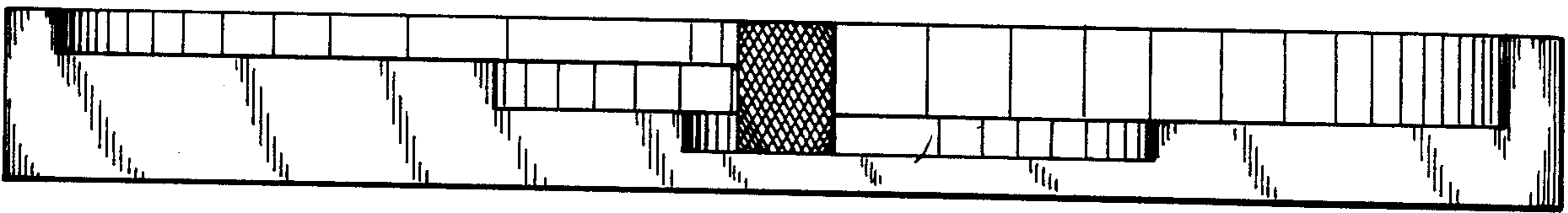
FIG. 5 is a back side elevational view thereof; and

FIG. 6 is a bottom perspective view thereof.

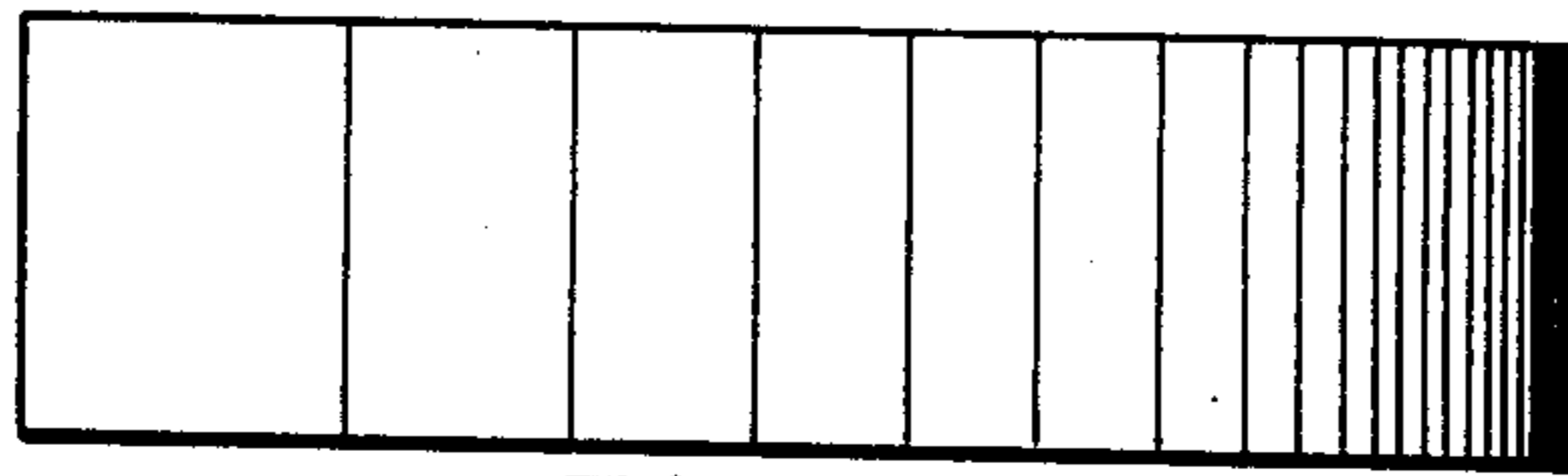




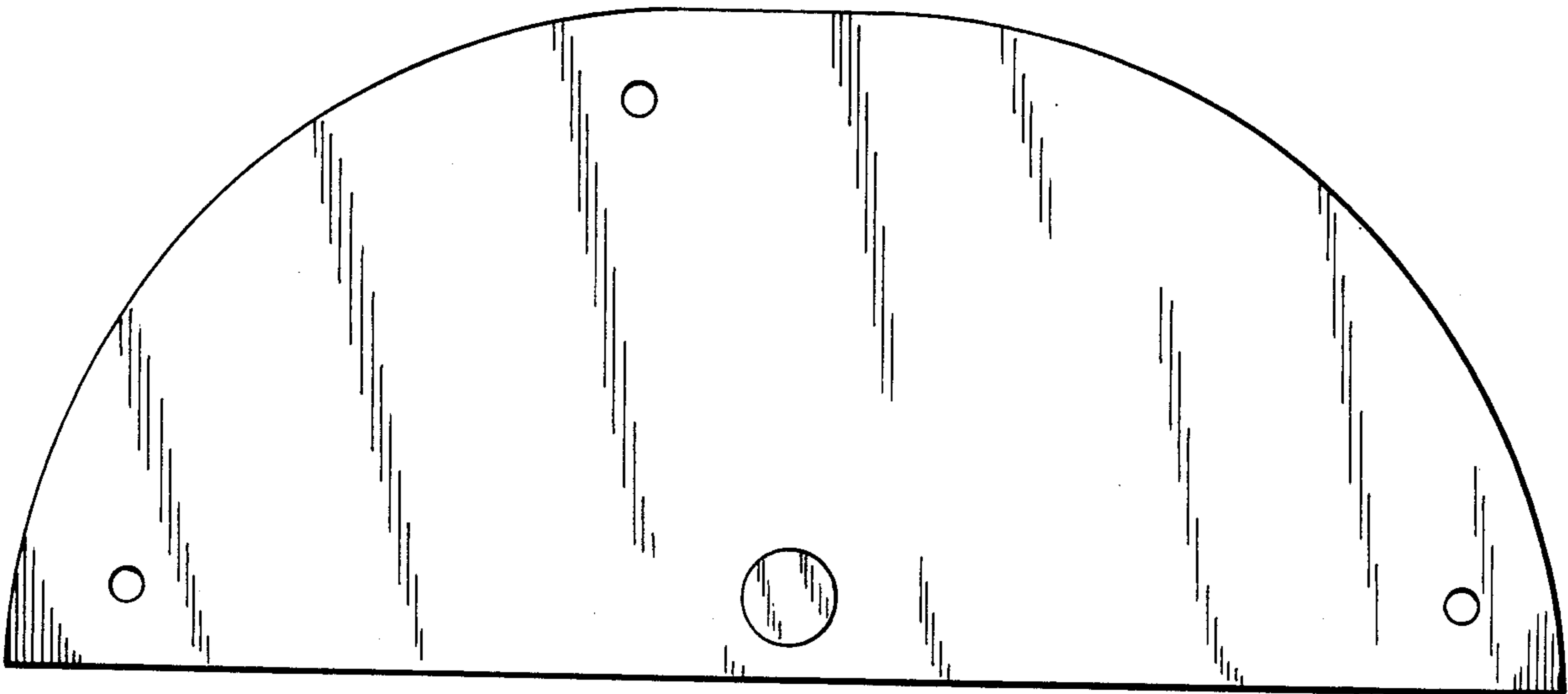
Fig_1



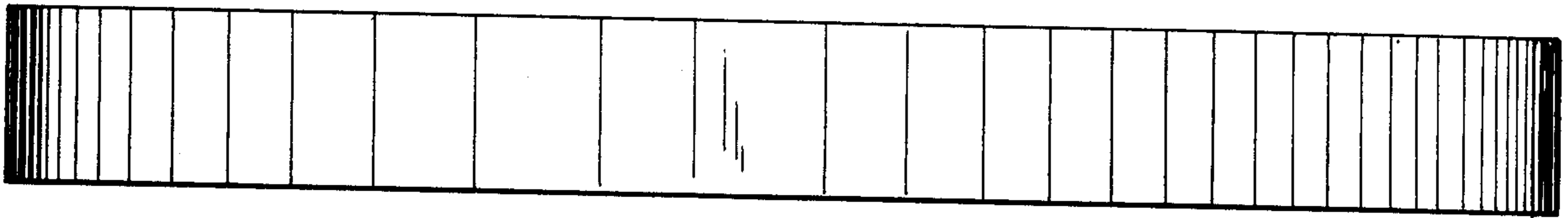
Fig_2



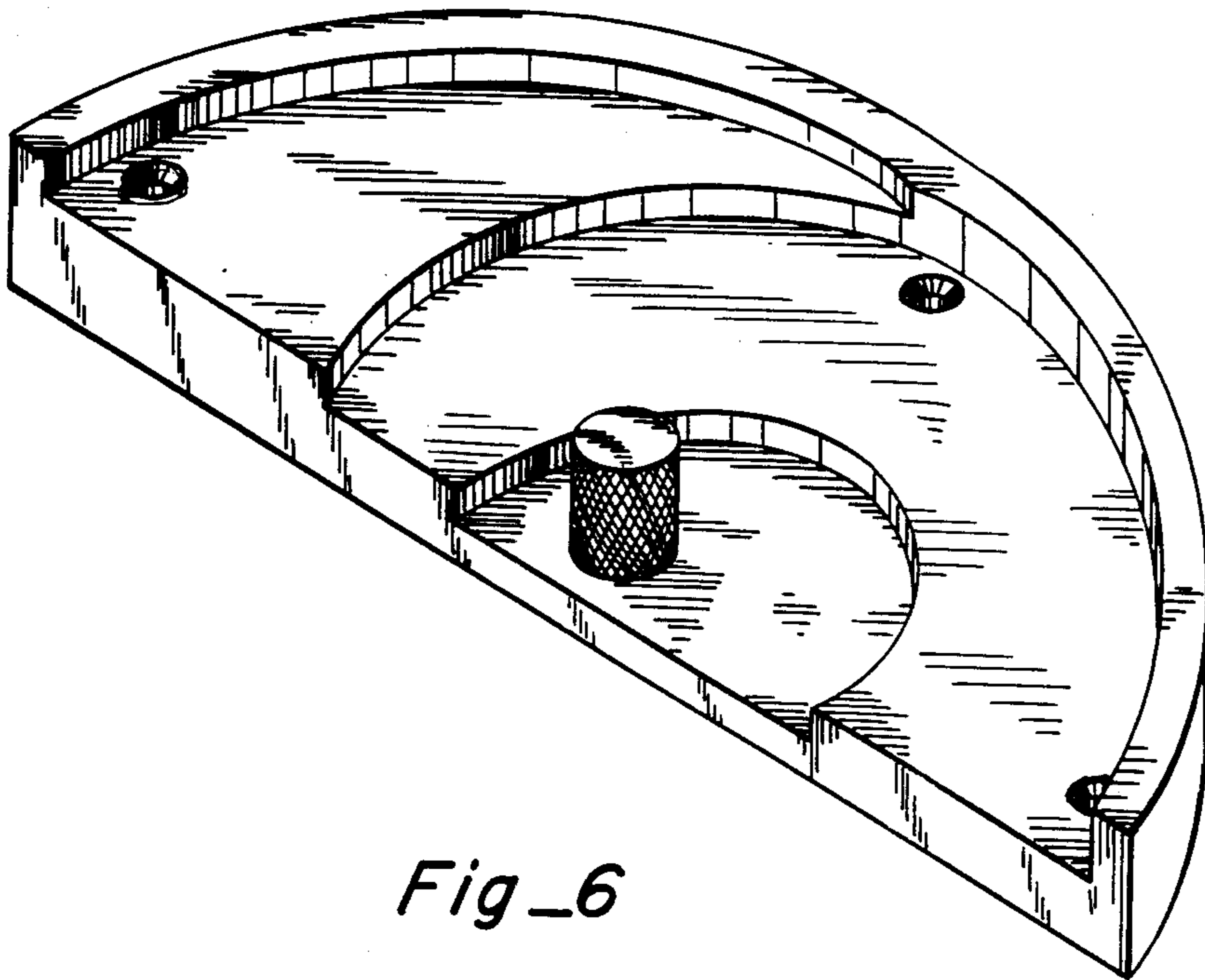
Fig_3



Fig_4



Fig_5



Fig_6