

[54] SKATE GUARD

[75] Inventor: Jan Färdigs, Leksand, Sweden

[73] Assignee: Joons Plastprodukter, Leksand, Sweden

[\*\*] Term: 14 Years

[21] Appl. No.: 711,380

[22] Filed: Aug. 3, 1976

[30] Foreign Application Priority Data

Feb. 25, 1976 [SE] Sweden ..... 76-0444

[51] Int. Cl. .... D21-02

[52] U.S. Cl. .... D34/14 B

[58] Field of Search ..... D34/14 R, 14 B, 14 D; 280/11.37 R, 11.37 M, 11.38, 11.37 E, 11.37 J, 11.37 T

[56]

References Cited

U.S. PATENT DOCUMENTS

1,554,434	9/1925	Johnson .....	280/11.38
1,557,415	10/1925	Carey .....	280/11.38
2,137,637	11/1938	Jorgensen .....	280/11.38
4,000,909	1/1977	Coale .....	280/11.37 E

Primary Examiner—Joel Stearman  
Assistant Examiner—C. A. Rademaker  
Attorney, Agent, or Firm—V. M. Creedon

[57]

CLAIM

The ornamental design for a skate guard, as shown.

DESCRIPTION

FIG. 1 is a front perspective view of a skate guard showing my new design;  
FIG. 2 is a rear perspective view thereof;  
FIG. 3 is a top plan view thereof;  
FIG. 4 is a bottom plan view thereof;  
FIG. 5 is a front elevational view thereof; and,  
FIG. 6 is a rear elevational view thereof.

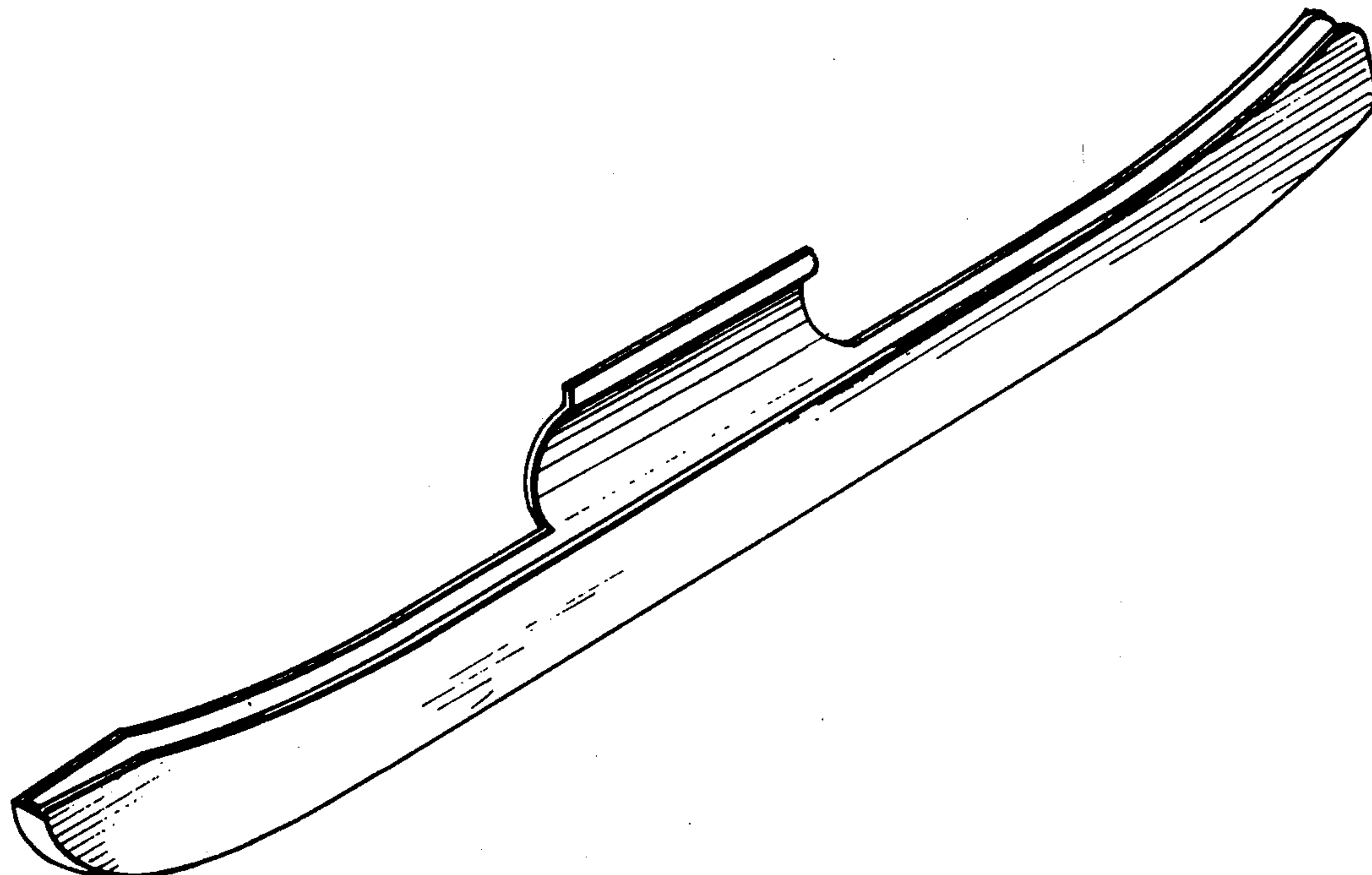

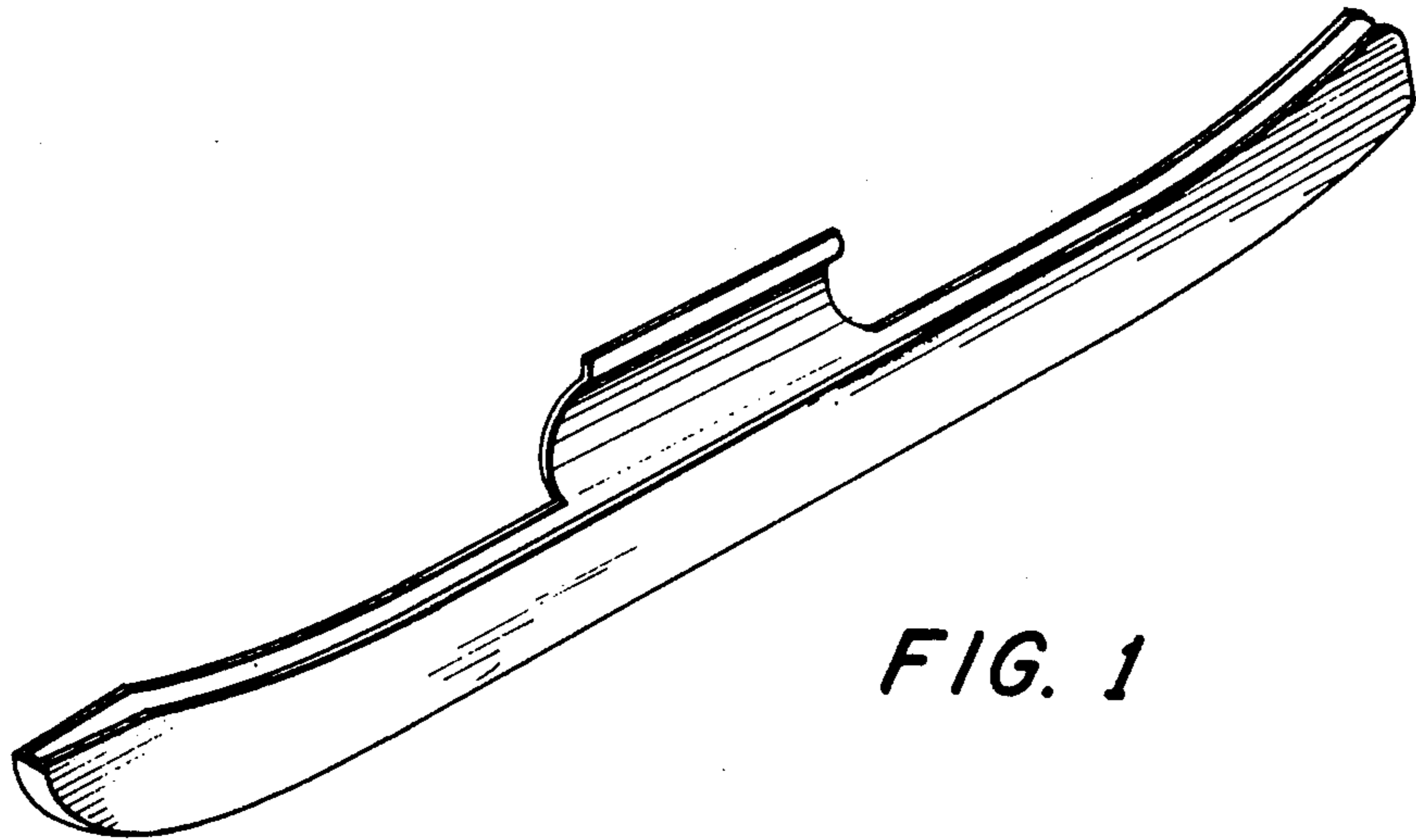

FIG. 1

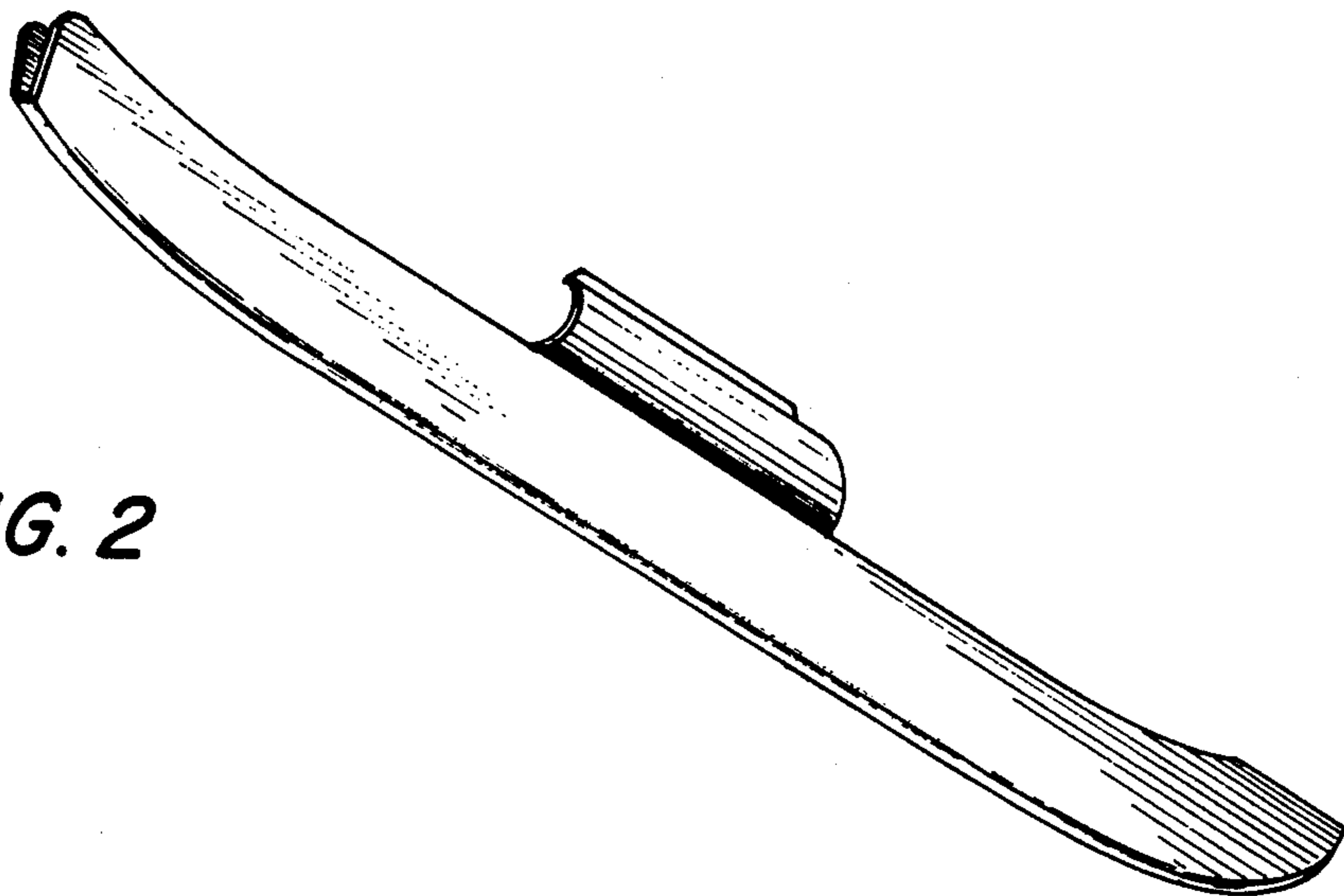

FIG. 2

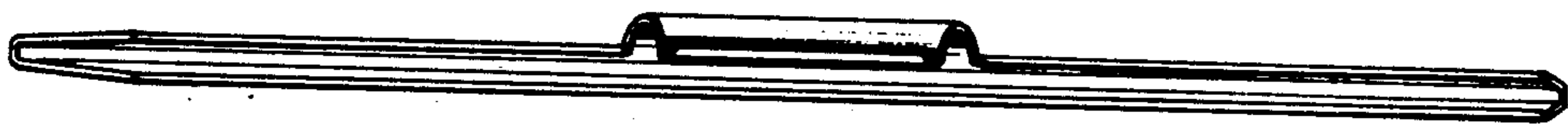

FIG. 3

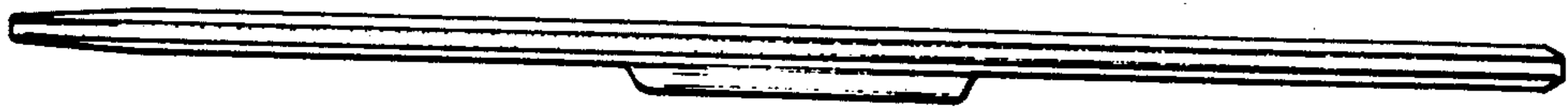

FIG 4

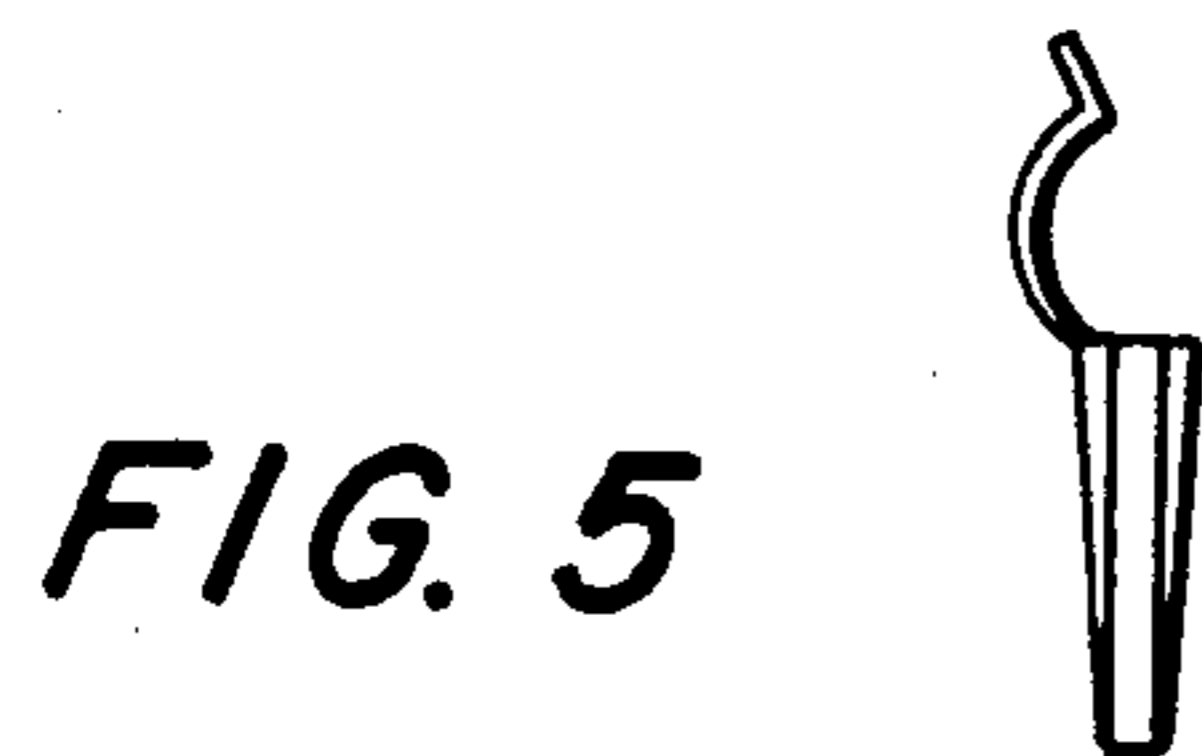

FIG. 5

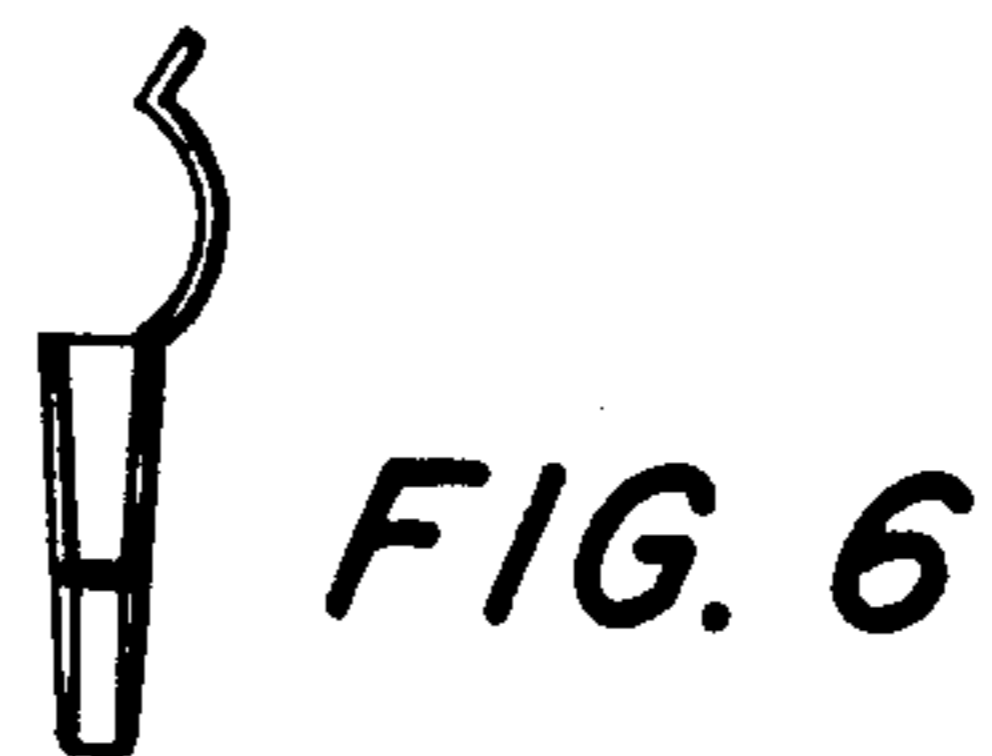

FIG. 6