

[54] SEWING MACHINE

[75] Inventor: George Donald LaPolice, Somerville, N.J.

[73] Assignee: The Singer Company

[**] Term: 14 Years

[21] Appl. No.: 739,752

[22] Filed: Nov. 8, 1976

[51] Int. Cl. D15-06

[52] U.S. Cl. D15/69

[58] Field of Search D15/66-72, D15/74, 76, 78; 112/258, 259

[56] References Cited

U.S. PATENT DOCUMENTS

D. 183,405 8/1958 Park D15/69

D. 210,053	1/1968	Dreyfuss	D15/69
D. 220,067	3/1971	Eguchi	D15/69
D. 225,574	12/1972	Grange et al.	D15/69
3,913,506	10/1975	Adams et al.	D15/69

Primary Examiner—Joel Stearman
Assistant Examiner—J. Corrigan
Attorney, Agent, or Firm—Robert E. Smith

[57] CLAIM

The ornamental design for a sewing machine, as shown.

DESCRIPTION

FIG. 1 is a front elevational view of a sewing machine showing my new design;
FIG. 2 is a rear elevational view;
FIG. 3 is a top plan view;
FIG. 4 is a left side elevational view;
FIG. 5 is a right side elevational view; and
FIG. 6 is a bottom plan view.

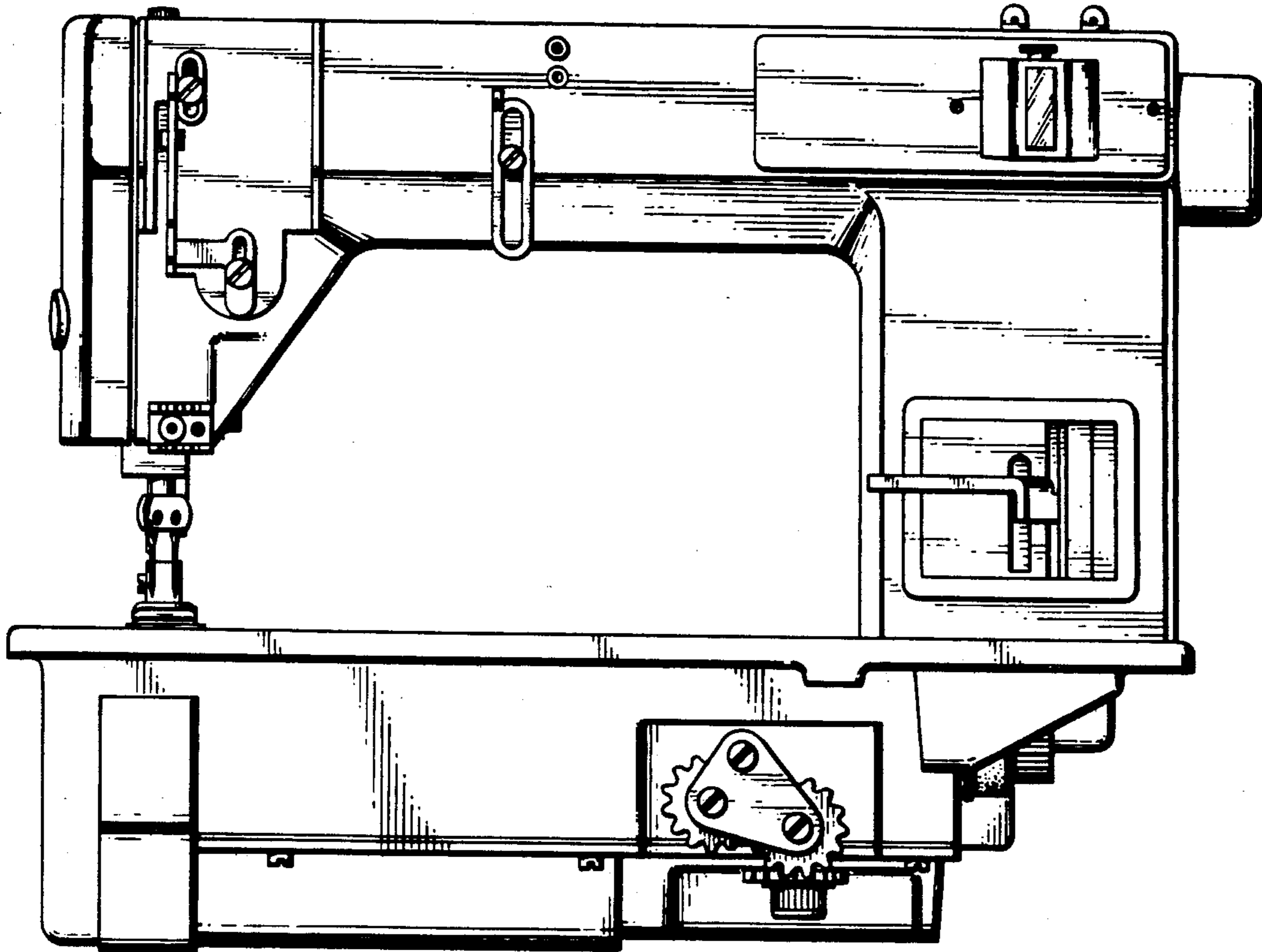

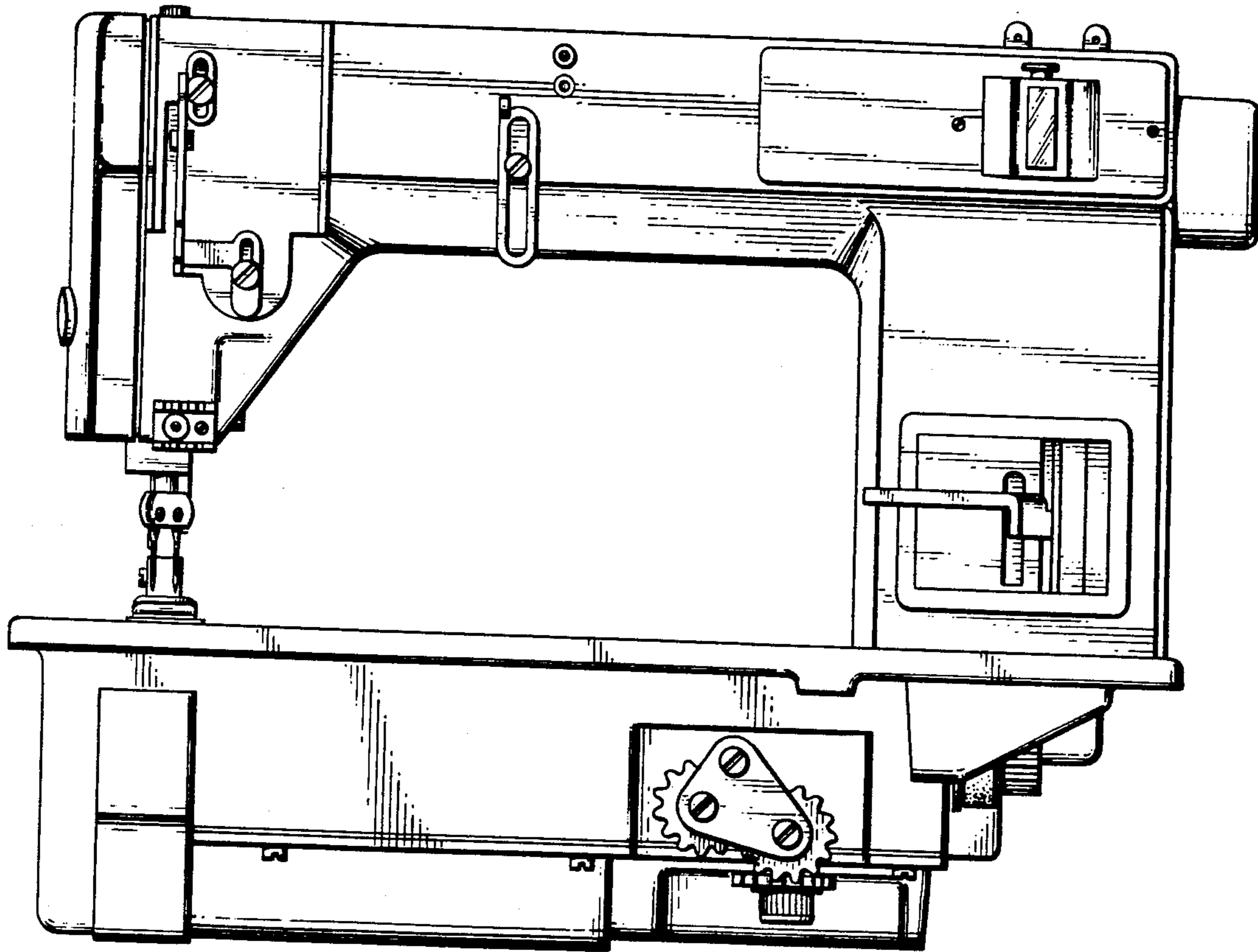

Fig. 1

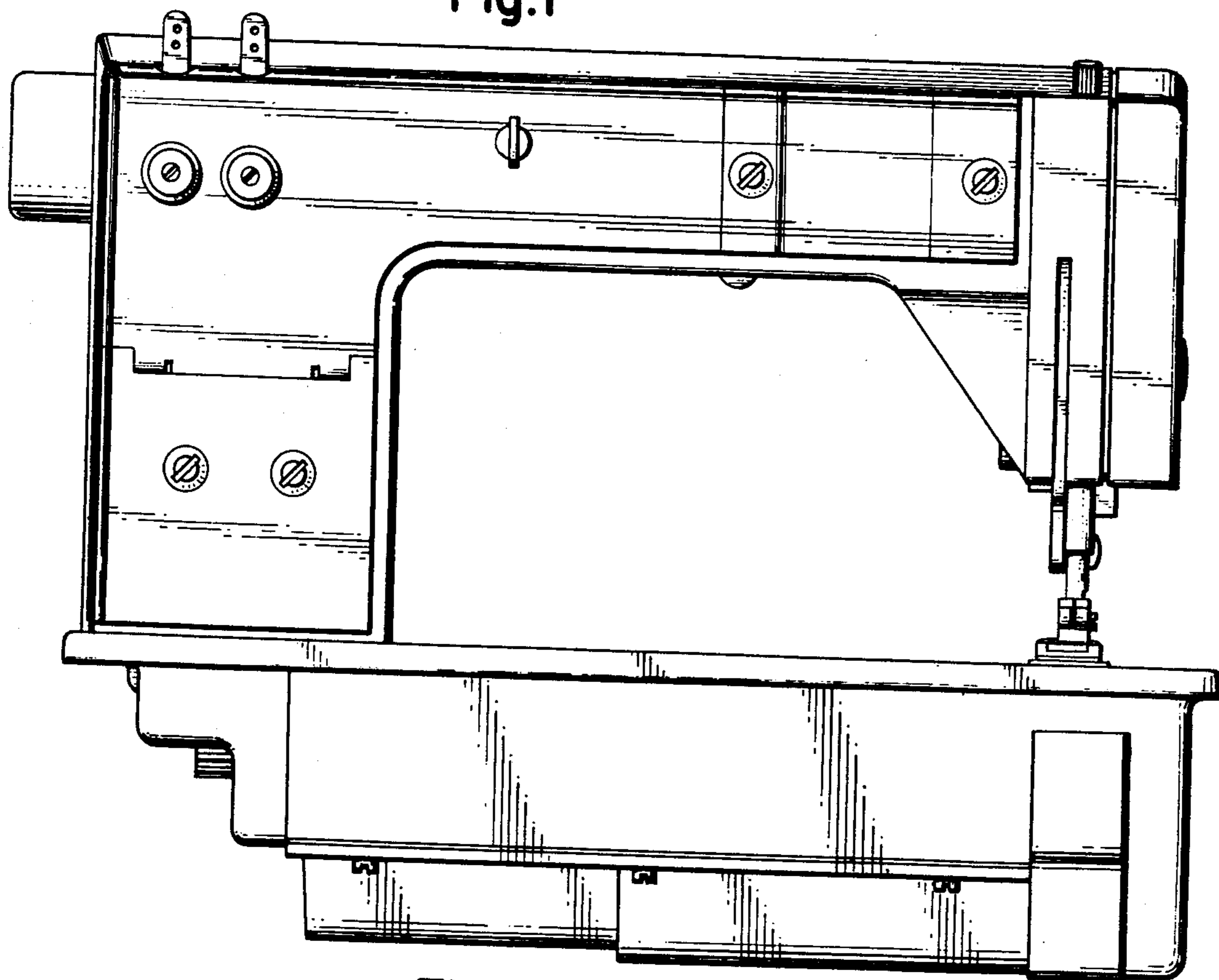

Fig. 2

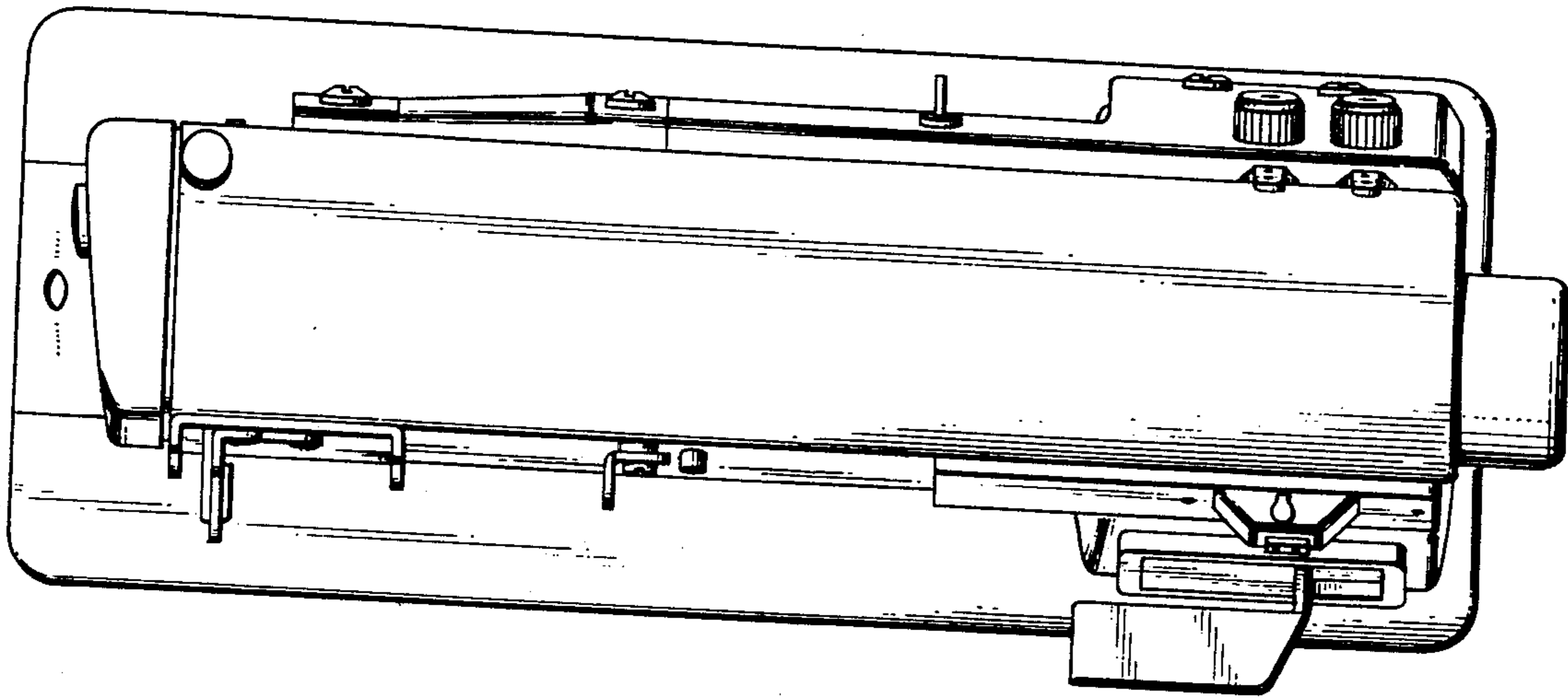

Fig. 3

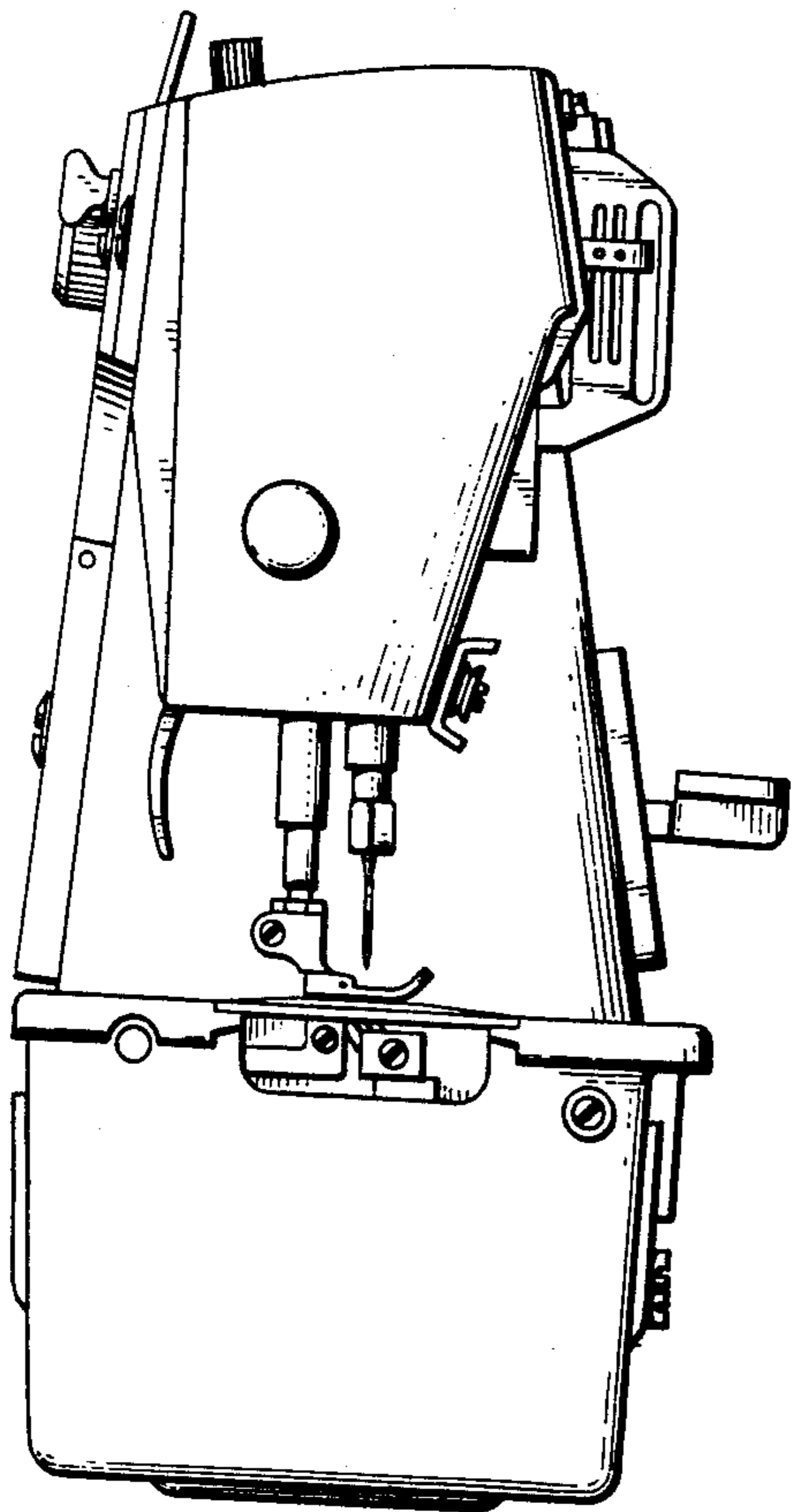

Fig. 4

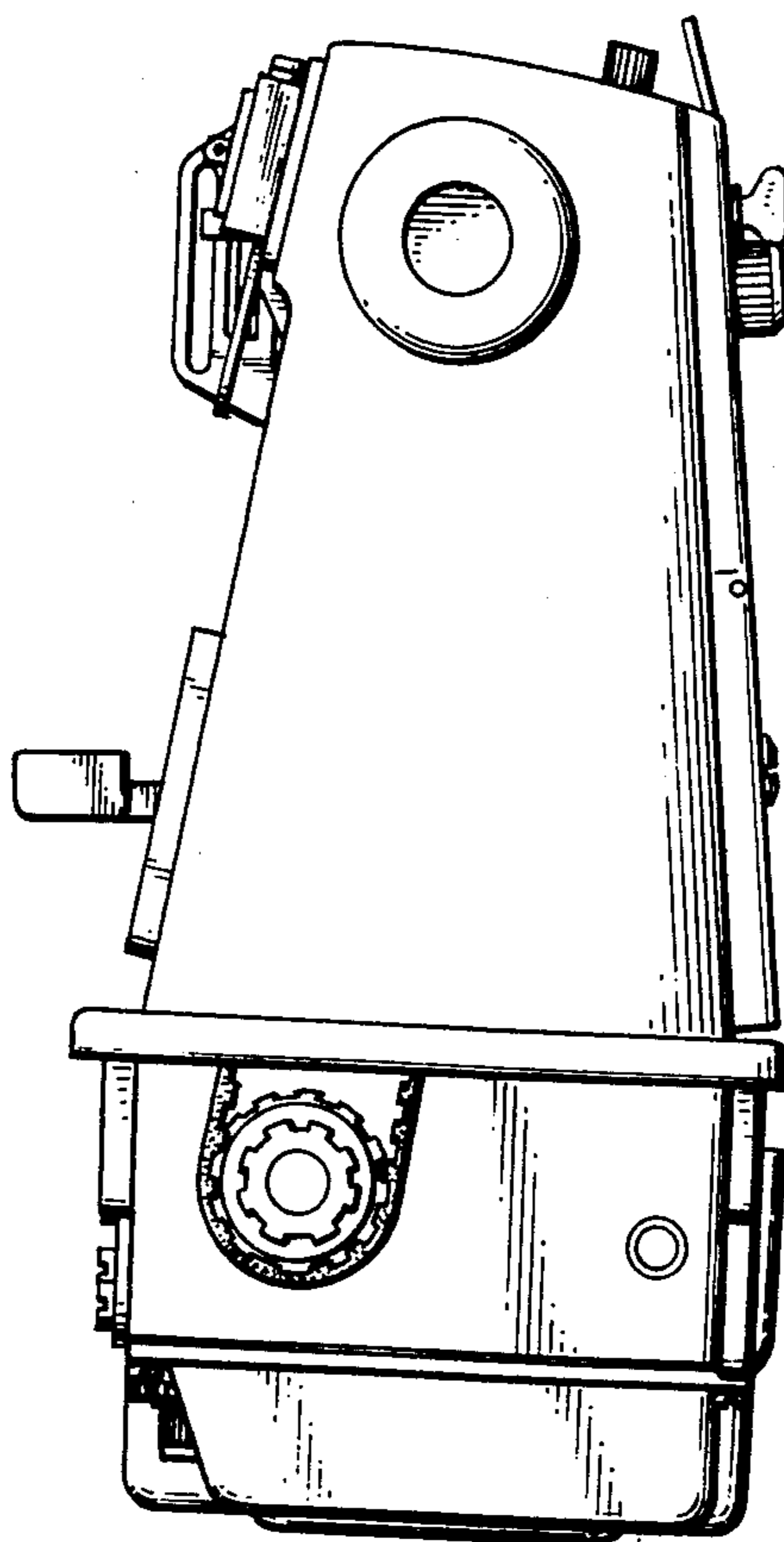

Fig. 5

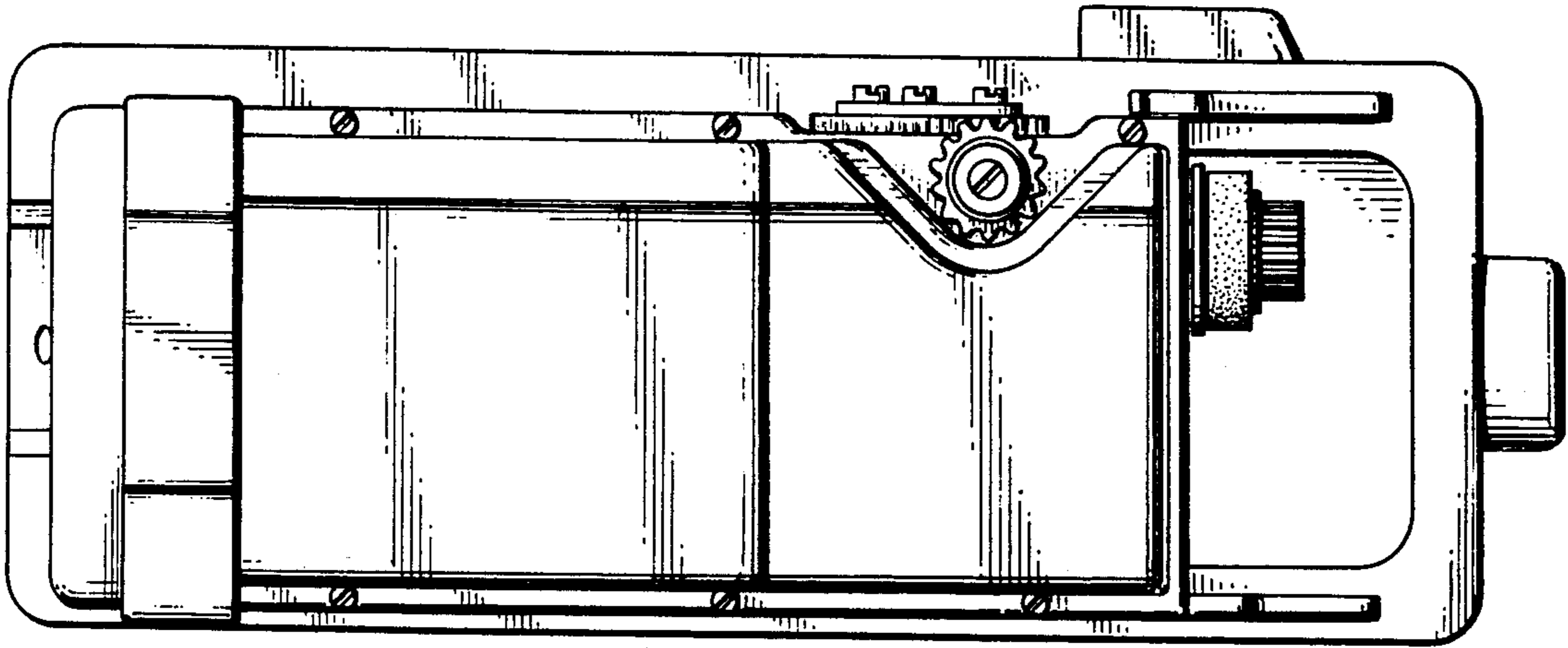

Fig.6